



The following excerpt are pages from the North American Product Technical Guide, Volume 2: Anchor Fastening, Edition 17.

Please refer to the publication in its entirety for complete details on this product including data development, product specifications, general suitability, installation, corrosion and spacing and edge distance guidelines.

US: <http://submittals.us.hilti.com/PTGVol2/>

CA: <http://submittals.us.hilti.com/PTGVol2CA/>

To consult directly with a team member regarding our anchor fastening products, contact Hilti's team of technical support specialists between the hours of 7:00am – 6:00pm CST.

US: 877-749-6337 or HNATechnicalServices@hilti.com

CA: 1-800-363-4458, ext. 6 or CATechnicalServices@hilti.com

3.2.4 HIT-RE 500 V3 Epoxy Adhesive Anchoring System

Hilti HIT-RE 500 V3 injection system

REV³OLUTIONARY.

How do we take the best and make it better? By listening to our customers!

Fifteen years ago, Hilti set legendary standards for designers and contractors alike with HIT-RE 500 – our first injectable epoxy anchors for post-installed rebar and anchoring applications. And because our customers needed the same high performance and maximum reliability for cracked concrete and seismic applications, Hilti introduced the first approved chemical anchor to do exactly that with HIT-RE 500-SD.

The new HIT-RE 500 V3 delivers ultimate performance and safety in design while making installation even easier and faster than ever before. Teamed up with SafeSet and PROFIS software, HIT-RE 500 V3 is nothing short of revolutionary.

Highlights

- Ultimate bond strength 60% higher than the current market leader HIT-RE 500-SD.
- Fastest cure time among epoxy anchors - Extremely versatile and less sensitive to low or high temperatures.
- Unique SafeSet system simplifies installation process and reduces the risk of human error.
- Pioneer in ICC approval for post-installed rebar connections.
- Along with HIT-HY 200 with the HIT-Z anchor rod, HIT-RE 500 V3 is the only product approved for diamond coring in cracked concrete with the TE-YRT roughening tool.

Applications

- Structural post-installed rebar connections, e.g. starter bars, beam to column connection, wall extension, etc.
- Heavy-duty fastenings in cracked and uncracked concrete, e.g. for structural beams, columns, silos, machinery, crash barriers, etc.
- Fastenings in diamond cored holes
- Post-installed anchoring in dry, wet, waterfilled or underwater.
- Seismic retrofits

Advantages

- Higher performance in shorter embedment depths leads to cost savings while maintaining the same loads.
- Fastest curing time and lower sensitivity to temperature conditions allows for unmatched productivity.
- More reliable and safer installation due to simplified cleaning process with SafeSet in hammer drilled and core drilled holes.
- The truly versatile HIT-RE 500 V3 delivers proven performance in applications where others can't.

Next generation performance...

The world's most trusted epoxy injectable mortar for post-installed anchors and rebar is now more advanced than ever. HIT-RE 500 V3 delivers higher bond strength and an even wider range of approved applications.

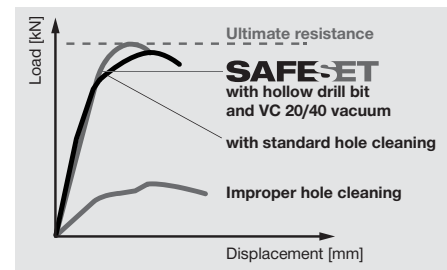
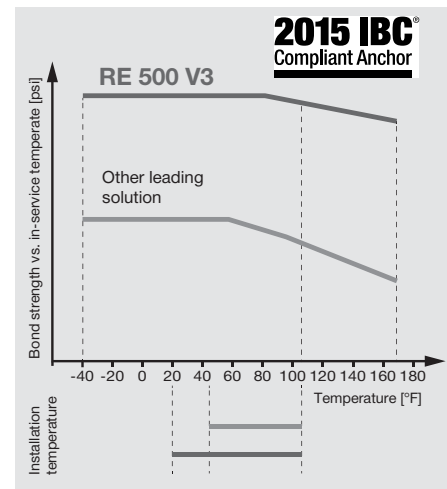
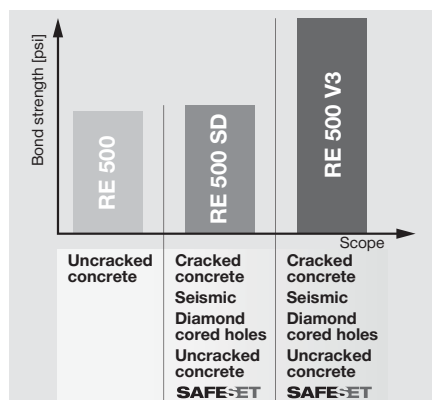

Anchor Performance with Hammer Drilled Holes

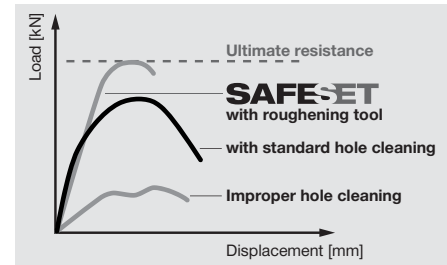

Anchor Performance with Diamond Core drilled holes

HIT-RE 500 V3 Epoxy Adhesive Anchoring System 3.2.4

...that goes to extremes!

Meet the epoxy anchor that is the least sensitive to temperature. HIT-RE 500 V3's endurance in extreme temperature ranges makes it suitable in blistering hot temperatures up to 172° F, to installation in frigidly cold temperatures- even down to 23° F! (77°C to -5°C). In addition, it is the fastest curing epoxy mortar in the market and cures in half the time of its predecessor, HIT-RE 500-SD.

Systematically better.

SafeSet eliminates the most load-affecting steps to make installation safe, simple and reliable. Hilti's hollow drill bit and VC 20/40 vacuum takes borehole cleaning out of the equation to provide maximum loads in all hammer drilled applications, while the new diamond roughening tool prepares diamond-cored holes for reliable anchor installations

In a class of its own.

Post-installed rebar connections. HIT-RE 500 V3 continues where HIT-RE 500-SD started as the first ICC-ES approved solution for post-installed rebar connections. Design is easy because this revolutionary epoxy works like cast-in rebar.

Diamond-cored anchoring in cracked concrete.

Hilti takes a revolutionary step forward with HIT-RE 500 V3 and the new TE-YRT roughening tool. This solution as well as the HIT-HY 200 adhesive with the HIT-Z Rod are the only ICC-ES approved systems in the industry and make installation in core drilled holes easy, productive and reliable.

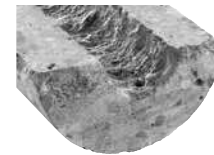

Diamond cored hole with roughening



Diamond cored hole

3.2.4

Anchoring applications



HIT-RE 500 V3 delivers high performance in shorter embedment depths...

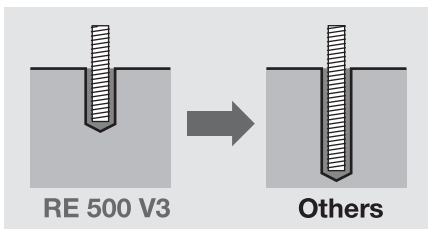

...and is backed by PROFIS Anchor software for easy design.

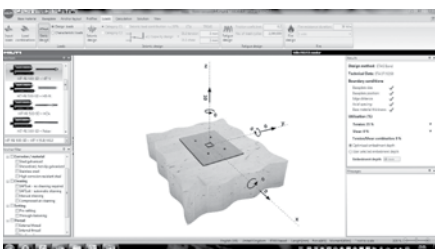

REV³OLUTIONARY



SYSTEM

Rebar applications



HIT-RE 500 V3 works like cast-in rebar...

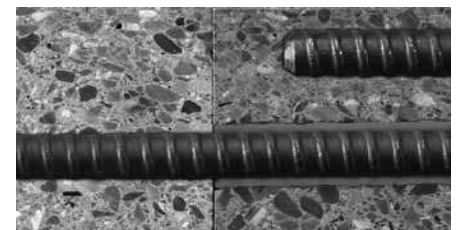

...and is backed by PROFIS Rebar software for easy design.

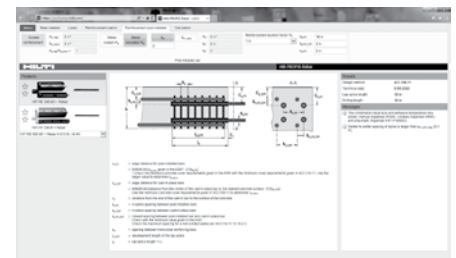

3.2.4 HIT-RE 500 V3 Epoxy Adhesive Anchoring System

3.2.4.1 Product description

3.2.4.2 Material specifications

3.2.4.3 Technical data

3.2.4.4 Installation instructions

3.2.4.5 Ordering information



Listings/Approvals

ICC-ES (International Code Council)
ESR-3814

NSF/ANSI Std 61

certification for use of HIT-RE 500 V3 in potable water

City of Los Angeles

Research Report No. 26028



Independent Code Evaluation

IBC®/IRC® 2015

(ICC-ES AC308/ACI 355.4)

IBC®/IRC® 2012

(ICC-ES AC308/ACI 355.4)

IBC®/IRC® 2009

(ICC-ES AC308)

IBC®/IRC® 2006

(ICC-ES AC308)

FBC 2014 w/ HVHZ



The Leadership in Energy and Environmental Design (LEED) Green

Building Rating system™ is the nationally accepted benchmark for the design, construction, and operation of high performance green buildings.

Department of Transportation

Contact Hilti to get a current list of State Departments of Transportation that have added HIT-RE 500 V3 to their qualified product listing.

3.2.4.1 Product description

The new HIT-RE 500 V3 adhesive anchoring system is an injectable two-component epoxy adhesive. The two components are kept separate by means of a dual-cylinder foil pack attached to a manifold.

The two components combine and react when dispensed through a static mixing nozzle attached to the manifold.

HIT-RE 500 V3 adhesive anchoring system may be used with continuously threaded rod, HIS-N and HIS-RN internally-threaded inserts or deformed reinforcing bar installed in cracked or uncracked concrete. The primary components of the Hilti adhesive anchoring system are:

- HIT-RE 500 V3 adhesive packaged in foil packs
- Adhesive mixing and dispensing equipment
- Equipment for hole cleaning and adhesive injection

Product Features

- Superior bond performance in both cracked and uncracked concrete
- Seismic qualified in accordance with ICC-ES Acceptance Criteria AC308 and ACI 355.4
- Use in diamond cored holes with roughening tool for cracked and uncracked concrete in all seismic zones
- Use underwater up to 165 ft (50 m)
- Meets requirements of ASTM C881-14, Type I, II, IV, and V, Grade 3, Class A, B, and C except linear shrinkage
- Meets requirements of AASHTO specification M235, Type I, II, IV, and V, Grade 3, Class A, B, and C except linear shrinkage

- Mixing tube provides proper mixing, eliminates measuring errors and minimizes waste
- Contains no styrene and virtually odorless
- Extended installation temperature range from 23°F to 104°F (-5°C to 40°C)
- Excellent weathering resistance and resistant to elevated temperature.
- Hilti technical data available for larger diameters, oversized holes, and deeper embedments. Contact Hilti Technical Services for additional information.

HIT-RE 500 V3 adhesive can be installed using two cleaning options:

1. Traditional cleaning methods comprised of steel wire brushes and air nozzles,
2. Self-cleaning methods using the Hilti TE-CD or TE-YD hollow carbide drill bits used in conjunction of a Hilti vacuum cleaner that will remove drilling dust, automatically cleaning the hole.

Elements that are suitable for use with this system are as follows: threaded steel rods, Hilti HIS-(R)N steel internally threaded inserts, and steel reinforcing bars.

HIT-RE 500 V3 is approved for use with the TE-YRT roughening tool. The tool is used for hole preparation in conjunction with holes core drilled with a diamond core bit to allow diamond coring in cracked and uncracked concrete in all seismic zones.

HIT-RE 500 V3 Epoxy Adhesive Anchoring System 3.2.4

Guide Specifications

Master Format Section:

Previous 2004 Format

03250 03 16 00 Concrete Anchors

Related Sections:

03200 03 20 00 Concrete Reinforcing

05050 05 50 00 Metal Fabrications

05120 05 10 00 Structural Metal Framing

Injectable adhesive shall be used for installation of all reinforcing steel dowels or threaded anchor rods and inserts into existing concrete. Adhesive shall be furnished in side-by-side refill packs which keep component A and component B separate. Side-by-side packs shall be designed to compress

during use to minimize waste volume. Side-by-side packs shall also be designed to accept static mixing nozzle which thoroughly blends component A and component B and allows injection directly into drilled hole. Only injection tools and static mixing nozzles as recommended by manufacturer shall be used. Manufacturer's instructions shall be followed. Injection adhesive shall be formulated to include resin and hardener to provide optimal curing speed as well as high strength and stiffness. Typical curing time at 68°F (20°C) shall be approximately 6.5 hours.

Injection adhesive shall be HIT-RE 500 V3, as furnished by Hilti.

Anchor rods shall be end stamped to show the grade of steel and overall rod length. Anchor rods shall be manufactured to meet the following requirements:

1. HAS-E carbon steel
2. ASTM A193, Grade B7 high strength carbon steel anchor
3. AISI Type 304 or AISI Type 316 stainless steel meeting the requirements of ASTM F593 condition CW

Special order HAS rods may vary from standard product.

Nuts and washers of other grades and styles having specified proof load strength greater than the specified grade and style are also suitable. Nuts must have specified proof load strength equal to or greater than the minimum tensile strength of the specified threaded rod.

3.2.4.2 Material specifications

Table 1 - Material properties of fully cured Hilti HIT-RE 500 V3

Bond Strength ASTM C882-13A ¹ 2 day cure 14 day cure	10.8 MPa 11.7 MPa	1,560 psi 1,690 psi
Compressive Strength ASTM D695-10 ¹	82.7 MPa	12,000 psi
Compressive Modulus ASTM D695-10 ¹	2,600 MPa	0.38 x 10 ⁶ psi
Tensile Strength 7 day ASTM D638-14	49.3 MPa	7,150 psi
Elongation at break ASTM D638-14	1.1%	1.1%
Heat Deflection Temperature ASTM D648-07	50°C	122°F
Absorption ASTM D570-98	0.18%	0.18%
Linear Coefficient of Shrinkage on Cure ASTM D2566-86	0.008	0.008

¹ Minimum values obtained as the result of tests at 35°F, 50°F, 75°F and 110°F.

Material specifications for Hilti HIT-V threaded rods, Hilti HAS threaded rods, and Hilti HIS-N inserts are listed in section 3.2.8.

3.2.4.3 Technical data

3.2.4.3.1 ACI 318-14 Chapter 17 design

The load values contained in this section are Hilti Simplified Design Tables. The load tables in this section were developed using the strength design parameters and variables of ESR-3814 and the equations within ACI 318-14 Chapter 17. For a detailed explanation of the Hilti Simplified Design Tables, refer to Section 3.1.8. Data tables from ESR-3814 are not contained in this section, but can be found at www.icc-es.org or at www.hilti.com.

3.2.4 HIT-RE 500 V3 Epoxy Adhesive Anchoring System

3.2.4.3.1 HIT-RE 500 V3 adhesive with deformed reinforcing bars (rebar)



Figure 1 - Rebar installed with Hilti HIT-RE 500 V3 adhesive

Cracked or uncracked concrete	Permissible drilling methods	Permissible concrete conditions
<p>Cracked and uncracked concrete</p>	<p>Hammer drilling with carbide-tipped drill bit</p>	<p>Dry concrete</p> <p>Water-saturated concrete</p> <p>Water-filled holes</p> <p>Submerged (underwater)</p>
	<p>Hilti TE-CD or TE-YD hollow drill bit and VC 20/40 vacuum</p> <p>Diamond core drill bit with Hilti TE-YRT roughening tool</p>	<p>Dry concrete</p> <p>Water-saturated concrete</p>
<p>Uncracked concrete</p>	<p>Diamond core drill bit</p>	<p>Dry concrete</p> <p>Water-saturated concrete</p>

Figure 2 - Rebar installed with Hilti HIT-RE 500 V3 adhesive

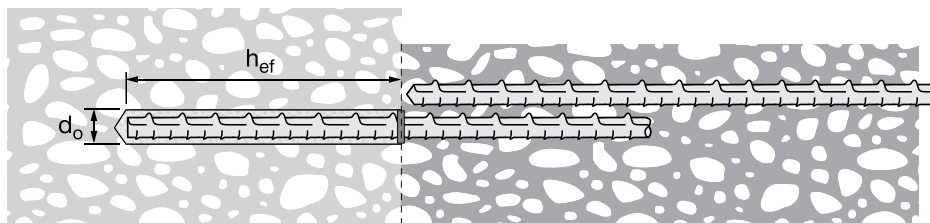

Table 2 - Specifications for rebar installed with Hilti HIT-RE 500 V3 adhesive

Setting information	Symbol	Units	Rebar size							
			#3	#4	#5	#6	#7	#8	#9	#10
Nominal bit diameter	d_n	in.	1/2	5/8	3/4	7/8	1	1-1/8	1-3/8	1-1/2
Effective embedment	minimum	$h_{ef,min}$	in. 2-3/8 (60)	in. 2-3/8 (60)	in. 3 (76)	in. 3 (76)	in. 3-3/8 (85)	in. 4 (102)	in. 4-1/2 (114)	in. 5 (127)
	maximum	$h_{ef,max}$	in. 7-1/2 (191)	in. 10 (254)	in. 12-1/2 (318)	in. 15 (381)	in. 17-1/2 (445)	in. 20 (508)	in. 22-1/2 (572)	in. 25 (635)
Minimum concrete member thickness	h_{min}	in.	$h_{ef} + 1-1/4$ ($h_{ef} + 30$)			$(h_{ef} + 2d_o)$				
Minimum edge distance ¹	c_{min}	in.	1-7/8 (48)	2-1/2 (64)	3-1/8 (79)	3-3/4 (95)	4-3/8 (111)	5 (127)	5-5/8 (143)	6-1/4 (159)
Minimum anchor spacing	s_{min}	in.	1-7/8 (48)	2-1/2 (64)	3-1/8 (79)	3-3/4 (95)	4-3/8 (111)	5 (127)	5-5/8 (143)	6-1/4 (159)

¹ Edge distance of 1-3/4-inch (44mm) is permitted provided the rebar remains un-torqued.

Note: The installation specifications in table 2 above and the data in tables 3 through 23 pertain to the use of Hilti HIT-RE 500 V3 with rebar designed as a post-installed anchor using the provisions of ACI 318-14 Chapter 17. For the use of Hilti HIT-RE 500 V3 with rebar for typical development calculations according to ACI 318-14 Chapter 25 (formerly ACI 318-11 Chapter 12), refer to section 3.1.14 for the design method and tables 83 through 87 in section 3.2.4.3.8.

HIT-RE 500 V3 Epoxy Adhesive Anchoring System 3.2.4

Table 3 - Hilti HIT-RE 500 V3 adhesive design strength with concrete / bond failure for US rebar in uncracked concrete ^{1,2,3,4,5,6,7,8,9,11}

Rebar size	Effective embedment in. (mm)	Tension — ϕN_n				Shear — ϕV_n			
		$f'_c = 2,500$ psi (17.2 MPa) lb (kN)	$f'_c = 3,000$ psi (20.7 MPa) lb (kN)	$f'_c = 4,000$ psi (27.6 MPa) lb (kN)	$f'_c = 6,000$ psi (41.4 MPa) lb (kN)	$f'_c = 2,500$ psi (17.2 MPa) lb (kN)	$f'_c = 3,000$ psi (20.7 MPa) lb (kN)	$f'_c = 4,000$ psi (27.6 MPa) lb (kN)	$f'_c = 6,000$ psi (41.4 MPa) lb (kN)
#3	3-3/8 (86)	4,575 (20.4)	4,790 (21.3)	5,145 (22.9)	5,695 (25.3)	9,855 (43.8)	10,310 (45.9)	11,080 (49.3)	12,265 (54.6)
	4-1/2 (114)	6,100 (27.1)	6,385 (28.4)	6,860 (30.5)	7,590 (33.8)	13,135 (58.4)	13,750 (61.2)	14,775 (65.7)	16,350 (72.7)
	7-1/2 (191)	10,165 (45.2)	10,640 (47.3)	11,435 (50.9)	12,655 (56.3)	21,895 (97.4)	22,915 (101.9)	24,625 (109.5)	27,250 (121.2)
#4	4-1/2 (114)	7,445 (33.1)	8,155 (36.3)	8,990 (40.0)	9,950 (44.3)	16,035 (71.3)	17,570 (78.2)	19,365 (86.1)	21,430 (95.3)
	6 (152)	10,660 (47.4)	11,155 (49.6)	11,990 (53.3)	13,265 (59.0)	22,960 (102.1)	24,030 (106.9)	25,820 (114.9)	28,575 (127.1)
	10 (254)	17,765 (79.0)	18,595 (82.7)	19,980 (88.9)	22,110 (98.3)	38,265 (170.2)	40,050 (178.2)	43,035 (191.4)	47,625 (211.8)
#5 ¹⁰	5-5/8 (143)	10,405 (46.3)	11,400 (50.7)	13,165 (58.6)	15,370 (68.4)	22,415 (99.7)	24,550 (109.2)	28,350 (126.1)	33,105 (147.3)
	7-1/2 (191)	16,020 (71.3)	17,230 (76.6)	18,515 (82.4)	20,490 (91.1)	34,505 (153.5)	37,115 (165.1)	39,880 (177.4)	44,135 (196.3)
	12-1/2 (318)	27,440 (122.1)	28,720 (127.8)	30,860 (137.3)	34,155 (151.9)	59,100 (262.9)	61,855 (275.1)	66,470 (295.7)	73,560 (327.2)
#6 ¹⁰	6-3/4 (171)	13,680 (60.9)	14,985 (66.7)	17,305 (77.0)	21,190 (94.3)	29,460 (131.0)	32,275 (143.6)	37,265 (165.8)	45,645 (203.0)
	9 (229)	21,060 (93.7)	23,070 (102.6)	26,200 (116.5)	28,995 (129.0)	45,360 (201.8)	49,690 (221.0)	56,430 (251.0)	62,450 (277.8)
	15 (381)	38,825 (172.7)	40,635 (180.8)	43,665 (194.2)	48,325 (215.0)	83,620 (372.0)	87,520 (389.3)	94,045 (418.3)	104,080 (463.0)
#7 ¹⁰	7-7/8 (200)	17,235 (76.7)	18,885 (84.0)	21,805 (97.0)	26,705 (118.8)	37,125 (165.1)	40,670 (180.9)	46,960 (208.9)	57,515 (255.8)
	10-1/2 (267)	26,540 (118.1)	29,070 (129.3)	33,570 (149.3)	38,995 (173.5)	57,160 (254.3)	62,615 (278.5)	72,300 (321.6)	83,995 (373.6)
	17-1/2 (445)	52,220 (232.3)	54,655 (243.1)	58,730 (261.2)	64,995 (289.1)	112,470 (500.3)	117,715 (523.6)	126,495 (562.7)	139,990 (622.7)
#8 ¹⁰	9 (229)	21,060 (93.7)	23,070 (102.6)	26,640 (118.5)	32,625 (145.1)	45,360 (201.8)	49,690 (221.0)	57,375 (255.2)	70,270 (312.6)
	12 (305)	32,425 (144.2)	35,520 (158.0)	41,015 (182.4)	50,020 (222.5)	69,835 (310.6)	76,500 (340.3)	88,335 (392.9)	107,735 (479.2)
	20 (508)	66,980 (297.9)	70,100 (311.8)	75,330 (335.1)	83,365 (370.8)	144,260 (641.7)	150,990 (671.6)	162,250 (721.7)	179,560 (798.7)
#9 ¹⁰	10-1/8 (257)	25,130 (111.8)	27,530 (122.5)	31,785 (141.4)	38,930 (173.2)	54,125 (240.8)	59,290 (263.7)	68,465 (304.5)	83,850 (373.0)
	13-1/2 (343)	38,690 (172.1)	42,380 (188.5)	48,940 (217.7)	59,940 (266.6)	83,330 (370.7)	91,285 (406.1)	105,405 (468.9)	129,095 (574.2)
	22-1/2 (572)	83,245 (370.3)	87,640 (389.8)	94,175 (418.9)	104,225 (463.6)	179,300 (797.6)	188,765 (839.7)	202,840 (902.3)	224,480 (998.5)
#10	11-1/4 (286)	29,430 (130.9)	32,240 (143.4)	37,230 (165.6)	45,595 (202.8)	63,395 (282.0)	69,445 (308.9)	80,185 (356.7)	98,205 (436.8)
	15 (381)	45,315 (201.6)	49,640 (220.8)	57,320 (255.0)	70,200 (312.3)	97,600 (434.1)	106,915 (475.6)	123,455 (549.2)	151,200 (672.6)
	25 (635)	97,500 (433.7)	106,195 (472.4)	114,115 (507.6)	126,290 (561.8)	210,000 (934.1)	228,730 (1017.4)	245,785 (1093.3)	272,005 (1209.9)

3.2.4

- See Section 3.1.8 for explanation on development of load values.
- See Section 3.1.8.6 to convert design strength value to ASD value.
- Linear interpolation between embedment depths and concrete compressive strengths is not permitted.
- Apply spacing, edge distance, and concrete thickness factors in tables 8-23 as necessary to the above values. Compare to the steel values in table 7. The lesser of the values is to be used for the design.
- Data is for temperature range A: Max. short term temperature = 130°F (55°C), max. long term temperature = 110°F (43°C). For temperature range B: Max. short term temperature = 176°F (80°C), max. long term temperature = 110°F (43°C) multiply above values by 0.69. Short term elevated concrete temperatures are those that occur over brief intervals, e.g., as a result of diurnal cycling. Long term concrete temperatures are roughly constant over significant periods of time.
- Tabular values are for dry concrete and water-saturated concrete conditions. For water-filled drilled holes multiply design strength by 0.51. For submerged (under water) applications multiply design strength by 0.45.
- Tabular values are for short term loads only. For sustained loads including overhead use, see Section 3.1.8.8.
- Tabular values are for normal-weight concrete only. For lightweight concrete multiply design strength by λ_a as follows: For sand-lightweight, $\lambda_a = 0.51$. For all-lightweight, $\lambda_a = 0.45$.
- Tabular values are for holes drilled in concrete with carbide tipped hammer drill bit. For diamond core drilling, except as indicated in note 10, multiply above values by 0.55. Diamond core drilling is not permitted for the water-filled or under-water (submerged) applications.
- Diamond core drilling with the Hilti TE-YRT roughening tool is permitted for #5, #6, #7, #8, and #9 rebar in dry and water-saturated concrete. See Table 5
- Tabular values are for static loads only. Seismic design is not permitted for uncracked concrete.

3.2.4 HIT-RE 500 V3 Epoxy Adhesive Anchoring System

Table 4 - Hilti HIT-RE 500 V3 adhesive design strength with concrete / bond failure for US rebar in cracked concrete^{1,2,3,4,5,6,7,8,9,11}

Rebar size	Effective embedment in. (mm)	Tension — ϕN_n				Shear — ϕV_n			
		$f'_c = 2,500$ psi (17.2 MPa) lb (kN)	$f'_c = 3,000$ psi (20.7 MPa) lb (kN)	$f'_c = 4,000$ psi (27.6 MPa) lb (kN)	$f'_c = 6,000$ psi (41.4 MPa) lb (kN)	$f'_c = 2,500$ psi (17.2 MPa) lb (kN)	$f'_c = 3,000$ psi (20.7 MPa) lb (kN)	$f'_c = 4,000$ psi (27.6 MPa) lb (kN)	$f'_c = 6,000$ psi (41.4 MPa) lb (kN)
#3	3-3/8 (86)	3,425 (15.2)	3,585 (15.9)	3,745 (16.7)	3,980 (17.7)	7,380 (32.8)	7,725 (34.4)	8,065 (35.9)	8,570 (38.1)
	4-1/2 (114)	4,650 (20.7)	4,780 (21.3)	4,990 (22.2)	5,305 (23.6)	10,020 (44.6)	10,300 (45.8)	10,750 (47.8)	11,425 (50.8)
	7-1/2 (191)	7,755 (34.5)	7,970 (35.5)	8,320 (37.0)	8,840 (39.3)	16,700 (74.3)	17,165 (76.4)	17,920 (79.7)	19,045 (84.7)
#4	4-1/2 (114)	5,275 (23.5)	5,780 (25.7)	6,670 (29.7)	7,125 (31.7)	11,360 (50.5)	12,445 (55.4)	14,370 (63.9)	15,345 (68.3)
	6 (152)	8,120 (36.1)	8,560 (38.1)	8,940 (39.8)	9,500 (42.3)	17,490 (77.8)	18,440 (82.0)	19,255 (85.7)	20,465 (91.0)
	10 (254)	13,885 (61.8)	14,270 (63.5)	14,900 (66.3)	15,835 (70.4)	29,910 (133.0)	30,735 (136.7)	32,095 (142.8)	34,105 (151.7)
#5 ¹⁰	5-5/8 (143)	7,370 (32.8)	8,075 (35.9)	9,325 (41.5)	11,380 (50.6)	15,875 (70.6)	17,390 (77.4)	20,080 (89.3)	24,510 (109.0)
	7-1/2 (191)	11,350 (50.5)	12,430 (55.3)	14,275 (63.5)	15,170 (67.5)	24,440 (108.7)	26,775 (119.1)	30,750 (136.8)	32,680 (145.4)
	12-1/2 (318)	22,175 (98.6)	22,790 (101.4)	23,795 (105.8)	25,285 (112.5)	47,760 (212.4)	49,085 (218.3)	51,250 (228.0)	54,465 (242.3)
#6 ¹⁰	6-3/4 (171)	9,690 (43.1)	10,615 (47.2)	12,255 (54.5)	15,010 (66.8)	20,870 (92.8)	22,860 (101.7)	26,395 (117.4)	32,330 (143.8)
	9 (229)	14,920 (66.4)	16,340 (72.7)	18,870 (83.9)	22,160 (98.6)	32,130 (142.9)	35,195 (156.6)	40,640 (180.8)	47,735 (212.3)
	15 (381)	32,095 (142.8)	33,290 (148.1)	34,760 (154.6)	36,935 (164.3)	69,135 (307.5)	71,700 (318.9)	74,865 (333.0)	79,560 (353.9)
#7 ¹⁰	7-7/8 (200)	12,210 (54.3)	13,375 (59.5)	15,445 (68.7)	18,915 (84.1)	26,300 (117.0)	28,810 (128.2)	33,265 (148.0)	40,740 (181.2)
	10-1/2 (267)	18,800 (83.6)	20,590 (91.6)	23,780 (105.8)	29,120 (129.5)	40,490 (180.1)	44,355 (197.3)	51,215 (227.8)	62,725 (279.0)
	17-1/2 (445)	40,445 (179.9)	44,310 (197.1)	47,310 (210.4)	50,275 (223.6)	87,115 (387.5)	95,430 (424.5)	101,895 (453.2)	108,285 (481.7)
#8 ¹⁰	9 (229)	14,920 (66.4)	16,340 (72.7)	18,870 (83.9)	23,110 (102.8)	32,130 (142.9)	35,195 (156.6)	40,640 (180.8)	49,775 (221.4)
	12 (305)	22,965 (102.2)	25,160 (111.9)	29,050 (129.2)	35,580 (158.3)	49,465 (220.0)	54,190 (241.0)	62,570 (278.3)	76,635 (340.9)
	20 (508)	49,415 (219.8)	54,135 (240.8)	62,230 (276.8)	66,130 (294.2)	106,435 (473.4)	116,595 (518.6)	134,035 (596.2)	142,440 (633.6)
#9 ¹⁰	10-1/8 (257)	17,800 (79.2)	19,500 (86.7)	22,515 (100.2)	27,575 (122.7)	38,340 (170.5)	42,000 (186.8)	48,495 (215.7)	59,395 (264.2)
	13-1/2 (343)	27,405 (121.9)	30,020 (133.5)	34,665 (154.2)	42,455 (188.8)	59,025 (262.6)	64,660 (287.6)	74,665 (332.1)	91,445 (406.8)
	22-1/2 (572)	58,965 (262.3)	64,595 (287.3)	74,585 (331.8)	81,930 (364.4)	127,005 (564.9)	139,125 (618.9)	160,650 (714.6)	176,465 (785.0)
#10	11-1/4 (286)	20,850 (92.7)	22,840 (101.6)	26,370 (117.3)	32,295 (143.7)	44,905 (199.7)	49,190 (218.8)	56,800 (252.7)	69,565 (309.4)
	15 (381)	32,095 (142.8)	35,160 (156.4)	40,600 (180.6)	49,725 (221.2)	69,135 (307.5)	75,730 (336.9)	87,445 (389.0)	107,100 (476.4)
	25 (635)	69,060 (307.2)	75,655 (336.5)	87,360 (388.6)	97,510 (433.7)	148,750 (661.7)	162,945 (724.8)	188,155 (837.0)	210,020 (934.2)

1 See Section 3.1.8 for explanation on development of load values.

2 See Section 3.1.8.6 to convert design strength value to ASD value.

3 Linear interpolation between embedment depths and concrete compressive strengths is not permitted.

4 Apply spacing, edge distance, and concrete thickness factors in tables 8-23 as necessary to the above values. Compare to the steel values in table 7. The lesser of the values is to be used for the design.

5 Data is for temperature range A: Max. short term temperature = 130°F (55°C), max. long term temperature = 110°F (43°C).

For temperature range B: Max. short term temperature = 176°F (80°C), max. long term temperature = 110°F (43°C) multiply above values by 0.69.

Short term elevated concrete temperatures are those that occur over brief intervals, e.g., as a result of diurnal cycling. Long term concrete temperatures are roughly constant over significant periods of time.

6 Tabular values are for dry concrete and water-saturated concrete conditions.

For water-filled drilled holes multiply design strength by 0.51.

For submerged (under water) applications multiply design strength by 0.45.

7 Tabular values are for short term loads only. For sustained loads including overhead use, see Section 3.1.8.8.

8 Tabular values are for normal-weight concrete only. For lightweight concrete multiply design strength by λ_a as follows:

For sand-lightweight, $\lambda_a = 0.51$. For all-lightweight, $\lambda_a = 0.45$.

9 Tabular values are for holes drilled in concrete with carbide tipped hammer drill bit. Diamond core drilling is not permitted in cracked concrete except as indicated in note 10.

10 Diamond core drilling with the Hilti TE-YRT roughening tool is permitted for #5, #6, #7, #8, and #9 rebar in dry and water-saturated concrete. See Table 6

11 Tabular values are for static loads only. For seismic loads, multiply cracked concrete tabular values in tension and shear by $\alpha_{\text{seis}} = 0.68$. See section 3.1.8.7 for additional information on seismic applications.

HIT-RE 500 V3 Epoxy Adhesive Anchoring System 3.2.4

Table 5 - Hilti HIT-RE 500 V3 for Core Drilled Holes with TE-YRT Roughening Tool adhesive design strength with concrete / bond failure for US rebar in uncracked concrete^{1,2,3,4,5,6,7,8,9}

Rebar size	Effective embedment in. (mm)	Tension — ϕN_n				Shear — ϕV_n			
		$f'_c = 2,500$ psi (17.2 MPa) lb (kN)	$f'_c = 3,000$ psi (20.7 MPa) lb (kN)	$f'_c = 4,000$ psi (27.6 MPa) lb (kN)	$f'_c = 6,000$ psi (41.4 MPa) lb (kN)	$f'_c = 2,500$ psi (17.2 MPa) lb (kN)	$f'_c = 3,000$ psi (20.7 MPa) lb (kN)	$f'_c = 4,000$ psi (27.6 MPa) lb (kN)	$f'_c = 6,000$ psi (41.4 MPa) lb (kN)
#5	5-5/8 (143)	10,405 (46.3)	11,400 (50.7)	12,350 (54.9)	12,350 (54.9)	22,415 (99.7)	24,550 (109.2)	26,595 (118.3)	26,595 (118.3)
	7-1/2 (191)	16,020 (71.3)	16,465 (73.2)	16,465 (73.2)	16,465 (73.2)	34,505 (153.5)	35,460 (157.7)	35,460 (157.7)	35,460 (157.7)
	12-1/2 (318)	27,440 (122.1)	27,440 (122.1)	27,440 (122.1)	27,440 (122.1)	59,100 (262.9)	59,100 (262.9)	59,100 (262.9)	59,100 (262.9)
#6	6-3/4 (171)	13,680 (60.9)	14,985 (66.7)	17,305 (77.0)	17,470 (77.7)	29,460 (131.0)	32,275 (143.6)	37,265 (165.8)	37,630 (167.4)
	9 (229)	21,060 (93.7)	23,070 (102.6)	23,295 (103.6)	23,295 (103.6)	45,360 (201.8)	49,690 (221.0)	50,175 (223.2)	50,175 (223.2)
	11-1/4 (286)	29,120 (129.5)	29,120 (129.5)	29,120 (129.5)	29,120 (129.5)	62,715 (279.0)	62,715 (279.0)	62,715 (279.0)	62,715 (279.0)
#7	7-7/8 (200)	17,235 (76.7)	18,885 (84.0)	21,805 (97.0)	23,500 (104.5)	37,125 (165.1)	40,670 (180.9)	46,960 (208.9)	50,610 (225.1)
	10-1/2 (267)	26,540 (118.1)	29,070 (129.3)	31,330 (139.4)	31,330 (139.4)	57,160 (254.3)	62,615 (278.5)	67,485 (300.2)	67,485 (300.2)
	17-1/2 (445)	52,220 (232.3)	52,220 (232.3)	52,220 (232.3)	52,220 (232.3)	112,470 (500.3)	112,470 (500.3)	112,470 (500.3)	112,470 (500.3)
#8	9 (229)	21,060 (93.7)	23,070 (102.6)	26,640 (118.5)	30,140 (134.1)	45,360 (201.8)	49,690 (221.0)	57,375 (255.2)	64,920 (288.8)
	12 (305)	32,425 (144.2)	35,520 (158.0)	40,185 (178.8)	40,185 (178.8)	69,835 (310.6)	76,500 (340.3)	86,555 (385.0)	86,555 (385.0)
	20 (508)	66,980 (297.9)	66,980 (297.9)	66,980 (297.9)	66,980 (297.9)	144,260 (641.7)	144,260 (641.7)	144,260 (641.7)	144,260 (641.7)
#9	10-1/8 (257)	25,130 (111.8)	27,530 (122.5)	31,785 (141.4)	37,680 (167.6)	54,125 (240.8)	59,290 (263.7)	68,465 (304.5)	81,160 (361.0)
	13-1/2 (343)	38,690 (172.1)	42,380 (188.5)	48,940 (217.7)	50,240 (223.5)	83,330 (370.7)	91,285 (406.1)	105,405 (468.9)	108,215 (481.4)
	22-1/2 (572)	83,245 (370.3)	83,735 (372.5)	83,735 (372.5)	83,735 (372.5)	179,300 (797.6)	180,355 (802.3)	180,355 (802.3)	180,355 (802.3)

3.2.4

- 1 See Section 3.1.8 for explanation on development of load values.
- 2 See Section 3.1.8.6 to convert design strength value to ASD value.
- 3 Linear interpolation between embedment depths and concrete compressive strengths is not permitted.
- 4 Apply spacing, edge distance, and concrete thickness factors in tables 8 - 23 as necessary to the above values. Compare to the steel values in table 7. The lesser of the values is to be used for the design.
- 5 Data is for temperature range A: Max. short term temperature = 130°F (55°C), max. long term temperature = 110°F (43°C).
For temperature range B: Max. short term temperature = 176°F (80°C), max. long term temperature = 110°F (43°C) multiply above values by 0.69.
Short term elevated concrete temperatures are those that occur over brief intervals, e.g., as a result of diurnal cycling. Long term concrete temperatures are roughly constant over significant periods of time.
- 6 Tabular values are for dry concrete and water-saturated concrete conditions.
Water-filled and submerged (under water) applications are not permitted for this hole preparation method.
- 7 Tabular values are for short term loads only. For sustained loads including overhead use, see Section 3.1.8.8.
- 8 Tabular values are for normal-weight concrete only. For lightweight concrete multiply design strength by λ_a as follows:
For sand-lightweight, $\lambda_a = 0.51$. For all-lightweight, $\lambda_a = 0.45$.
- 9 Tabular values are for static loads only. Seismic design is not permitted for uncracked concrete. For seismic loads, multiply cracked concrete tabular values in tension by $\alpha_{seis} = 0.68$. See section 3.1.8.7 for additional information on seismic applications.

3.2.4 HIT-RE 500 V3 Epoxy Adhesive Anchoring System

Table 6 - Hilti HIT-RE 500 V3 for Core Drilled Holes with TE-YRT Roughening Tool adhesive design strength with concrete / bond failure for US rebar in cracked concrete^{1,2,3,4,5,6,7,8,9}

Rebar size	Effective embedment in. (mm)	Tension — ϕN_n				Shear — ϕV_n			
		$f'_c = 2,500$ psi (17.2 MPa) lb (kN)	$f'_c = 3,000$ psi (20.7 MPa) lb (kN)	$f'_c = 4,000$ psi (27.6 MPa) lb (kN)	$f'_c = 6,000$ psi (41.4 MPa) lb (kN)	$f'_c = 2,500$ psi (17.2 MPa) lb (kN)	$f'_c = 3,000$ psi (20.7 MPa) lb (kN)	$f'_c = 4,000$ psi (27.6 MPa) lb (kN)	$f'_c = 6,000$ psi (41.4 MPa) lb (kN)
#5	5-5/8 (143)	6,965 (31.0)	6,965 (31.0)	6,965 (31.0)	6,965 (31.0)	15,000 (66.7)	15,000 (66.7)	15,000 (66.7)	15,000 (66.7)
	7-1/2 (191)	9,285 (41.3)	9,285 (41.3)	9,285 (41.3)	9,285 (41.3)	20,000 (89.0)	20,000 (89.0)	20,000 (89.0)	20,000 (89.0)
	12-1/2 (318)	15,475 (68.8)	15,475 (68.8)	15,475 (68.8)	15,475 (68.8)	33,330 (148.3)	33,330 (148.3)	33,330 (148.3)	33,330 (148.3)
#6	6-3/4 (171)	9,690 (43.1)	10,235 (45.5)	10,235 (45.5)	10,235 (45.5)	20,870 (92.8)	22,045 (98.1)	22,045 (98.1)	22,045 (98.1)
	9 (229)	13,645 (60.7)	13,645 (60.7)	13,645 (60.7)	13,645 (60.7)	29,390 (130.7)	29,390 (130.7)	29,390 (130.7)	29,390 (130.7)
	11-1/4 (286)	17,055 (75.9)	17,055 (75.9)	17,055 (75.9)	17,055 (75.9)	36,740 (163.4)	36,740 (163.4)	36,740 (163.4)	36,740 (163.4)
#7	7-7/8 (200)	12,210 (54.3)	13,375 (59.5)	13,930 (62.0)	13,930 (62.0)	26,300 (117.0)	28,810 (128.2)	30,005 (133.5)	30,005 (133.5)
	10-1/2 (267)	18,575 (82.6)	18,575 (82.6)	18,575 (82.6)	18,575 (82.6)	40,005 (178.0)	40,005 (178.0)	40,005 (178.0)	40,005 (178.0)
	17-1/2 (445)	30,955 (137.7)	30,955 (137.7)	30,955 (137.7)	30,955 (137.7)	66,675 (296.6)	66,675 (296.6)	66,675 (296.6)	66,675 (296.6)
#8	9 (229)	14,920 (66.4)	16,340 (72.7)	18,285 (81.3)	18,285 (81.3)	32,130 (142.9)	35,195 (156.6)	39,385 (175.2)	39,385 (175.2)
	12 (305)	22,965 (102.2)	24,380 (108.4)	24,380 (108.4)	24,380 (108.4)	49,465 (220.0)	52,515 (233.6)	52,515 (233.6)	52,515 (233.6)
	20 (508)	40,635 (180.8)	40,635 (180.8)	40,635 (180.8)	40,635 (180.8)	87,525 (389.3)	87,525 (389.3)	87,525 (389.3)	87,525 (389.3)
#9	10-1/8 (257)	17,800 (79.2)	19,500 (86.7)	22,515 (100.2)	22,560 (100.4)	38,340 (170.5)	42,000 (186.8)	48,495 (215.7)	48,595 (216.2)
	13-1/2 (343)	27,405 (121.9)	30,020 (133.5)	30,085 (133.8)	30,085 (133.8)	59,025 (262.6)	64,660 (287.6)	64,795 (288.2)	64,795 (288.2)
	22-1/2 (572)	50,140 (223.0)	50,140 (223.0)	50,140 (223.0)	50,140 (223.0)	107,990 (480.4)	107,990 (480.4)	107,990 (480.4)	107,990 (480.4)

1 See Section 3.1.8 for explanation on development of load values.

2 See Section 3.1.8.6 to convert design strength value to ASD value.

3 Linear interpolation between embedment depths and concrete compressive strengths is not permitted.

4 Apply spacing, edge distance, and concrete thickness factors in tables 8 - 23 as necessary to the above values. Compare to the steel values in table 7. The lesser of the values is to be used for the design.

5 Data is for temperature range A: Max. short term temperature = 130°F (55°C), max. long term temperature = 110°F (43°C).

For temperature range B: Max. short term temperature = 176°F (80°C), max. long term temperature = 110°F (43°C) multiply above values by 0.69.

Short term elevated concrete temperatures are those that occur over brief intervals, e.g., as a result of diurnal cycling. Long term concrete temperatures are roughly constant over significant periods of time.

6 Tabular values are for dry concrete and water-saturated concrete conditions.

Water-filled and submerged (under water) applications are not permitted for this hole preparation method.

7 Tabular values are for short term loads only. For sustained loads including overhead use, see Section 3.1.8.8.

8 Tabular values are for normal-weight concrete only. For lightweight concrete multiply design strength by λ_a as follows:

For sand-lightweight, $\lambda_a = 0.51$. For all-lightweight, $\lambda_a = 0.45$.

9 Tabular values are for static loads only. Seismic design is not permitted for uncracked concrete. For seismic loads, multiply cracked concrete tabular values in tension by $\alpha_{seis} = 0.68$. See section 3.1.8.7 for additional information on seismic applications.

HIT-RE 500 V3 Epoxy Adhesive Anchoring System 3.2.4

Table 7 - Steel design strength for US rebar¹

Rebar size	ASTM A 615 Grade 40 ²			ASTM A 615 Grade 60 ²			ASTM A 706 Grade 60 ²		
	Tensile ³ ϕN_{sa} lb (kN)	Shear ⁴ ϕV_{sa} lb (kN)	Seismic Shear ⁵ $\phi V_{sa,eq}$ lb (kN)	Tensile ³ ϕN_{sa} lb (kN)	Shear ⁴ ϕV_{sa} lb (kN)	Seismic Shear ⁵ $\phi V_{sa,eq}$ lb (kN)	Tensile ³ ϕN_{sa} lb (kN)	Shear ⁴ ϕV_{sa} lb (kN)	Seismic Shear ⁵ $\phi V_{sa,eq}$ lb (kN)
#3	4,290 (19.1)	2,375 (10.6)	1,665 (7.4)	6,435 (28.6)	3,565 (15.9)	2,495 (11.1)	6,600 (29.4)	3,430 (15.3)	2,400 (10.7)
#4	7,800 (34.7)	4,320 (19.2)	3,025 (13.5)	11,700 (52.0)	6,480 (28.8)	4,535 (20.2)	12,000 (53.4)	6,240 (27.8)	4,370 (19.4)
#5	12,090 (53.8)	6,695 (29.8)	4,685 (20.8)	18,135 (80.7)	10,045 (44.7)	7,030 (31.3)	18,600 (82.7)	9,670 (43.0)	6,770 (30.1)
#6	17,160 (76.3)	9,505 (42.3)	6,655 (29.6)	25,740 (114.5)	14,255 (63.4)	9,980 (44.4)	26,400 (117.4)	13,730 (61.1)	9,610 (42.7)
#7	23,400 (104.1)	12,960 (57.6)	9,070 (40.3)	35,100 (156.1)	19,440 (86.5)	13,610 (60.5)	36,000 (160.1)	18,720 (83.3)	13,105 (58.3)
#8	30,810 (137.0)	17,065 (75.9)	11,945 (53.1)	46,215 (205.6)	25,595 (113.9)	17,915 (79.7)	47,400 (210.8)	24,650 (109.6)	17,255 (76.8)
#9	39,000 (173.5)	21,600 (96.1)	15,120 (67.3)	58,500 (260.2)	32,400 (144.1)	22,680 (100.9)	60,000 (266.9)	31,200 (138.8)	21,840 (97.1)
#10	49,530 (220.3)	27,430 (122.0)	19,200 (85.4)	74,295 (330.5)	41,150 (183.0)	28,805 (128.1)	76,200 (339.0)	39,625 (176.3)	27,740 (123.4)

¹ See Section 3.1.8.6 to convert design strength value to ASD value.

² ASTM A706 Grade 60 rebar are considered ductile steel elements. ASTM A 615 Grade 40 and 60 rebar are considered brittle steel elements.

³ Tensile = $\phi A_s f_{uta}$ as noted in ACI 318-14 Chapter 17

⁴ Shear = $\phi 0.60 A_s f_{uta}$ as noted in ACI 318-14 Chapter 17

⁵ Seismic Shear = $\alpha_{V,seis} \phi V_{sa}$: Reduction for seismic shear only. See section 3.1.8.7 for additional information on seismic applications.

3.2.4 HIT-RE 500 V3 Epoxy Adhesive Anchoring System

Table 8 - Load adjustment factors for #3 rebar in uncracked concrete^{1,2,3}

#3 uncracked concrete	Spacing factor in tension			Edge distance factor in tension			Spacing factor in shear ⁴			Edge distance in shear						Concrete thickness factor in shear ⁵		
										⊥ Toward edge			∥ To and away from edge					
	f_{AN}	f_{RN}	f_{AV}	f_{RV}	f_{RV}	f_{RV}	f_{RV}	f_{RV}	f_{RV}	f_{RV}	f_{RV}	f_{RV}	f_{RV}	f_{RV}	f_{RV}	f_{RV}	f_{RV}	f_{RV}
Embedment h_{ef} in. (mm)	3-3/8 (86)	4-1/2 (114)	7-1/2 (191)	3-3/8 (86)	4-1/2 (114)	7-1/2 (191)	3-3/8 (86)	4-1/2 (114)	7-1/2 (191)	3-3/8 (86)	4-1/2 (114)	7-1/2 (191)	3-3/8 (86)	4-1/2 (114)	7-1/2 (191)	3-3/8 (86)	4-1/2 (114)	7-1/2 (191)
1-3/4 (44)	n/a	n/a	n/a	0.29	0.22	0.13	n/a	n/a	n/a	0.07	0.06	0.03	0.15	0.11	0.07	n/a	n/a	n/a
1-7/8 (48)	0.59	0.57	0.54	0.30	0.22	0.13	0.53	0.53	0.52	0.08	0.06	0.04	0.17	0.12	0.07	n/a	n/a	n/a
2 (51)	0.59	0.57	0.54	0.31	0.23	0.13	0.53	0.53	0.52	0.09	0.07	0.04	0.18	0.14	0.08	n/a	n/a	n/a
3 (76)	0.64	0.61	0.57	0.38	0.28	0.16	0.55	0.54	0.53	0.17	0.13	0.08	0.34	0.25	0.15	n/a	n/a	n/a
4 (102)	0.69	0.65	0.59	0.45	0.33	0.19	0.57	0.56	0.54	0.26	0.19	0.12	0.45	0.33	0.19	n/a	n/a	n/a
4-5/8 (117)	0.72	0.67	0.60	0.50	0.37	0.22	0.58	0.56	0.55	0.32	0.24	0.14	0.50	0.37	0.22	0.56	n/a	n/a
5 (127)	0.74	0.69	0.61	0.54	0.39	0.23	0.58	0.57	0.55	0.36	0.27	0.16	0.54	0.39	0.23	0.58	n/a	n/a
5-3/4 (146)	0.77	0.71	0.63	0.61	0.45	0.26	0.60	0.58	0.56	0.45	0.33	0.20	0.61	0.45	0.26	0.62	0.57	n/a
6 (152)	0.78	0.72	0.63	0.64	0.47	0.27	0.60	0.58	0.56	0.47	0.36	0.21	0.64	0.47	0.27	0.64	0.58	n/a
7 (178)	0.83	0.76	0.66	0.75	0.54	0.32	0.62	0.60	0.57	0.60	0.45	0.27	0.75	0.54	0.32	0.69	0.63	n/a
8 (203)	0.88	0.80	0.68	0.85	0.62	0.36	0.64	0.61	0.58	0.73	0.55	0.33	0.85	0.62	0.36	0.74	0.67	n/a
8-3/4 (222)	0.91	0.82	0.69	0.93	0.68	0.39	0.65	0.62	0.59	0.84	0.63	0.38	0.93	0.68	0.39	0.77	0.70	0.59
9 (229)	0.92	0.83	0.70	0.96	0.70	0.41	0.65	0.63	0.59	0.87	0.65	0.39	0.96	0.70	0.41	0.78	0.71	0.60
10 (254)	0.97	0.87	0.72	1.00	0.78	0.45	0.67	0.64	0.60	1.00	0.77	0.46	1.00	0.78	0.45	0.82	0.75	0.63
11 (279)	1.00	0.91	0.74		0.85	0.50	0.69	0.65	0.61		0.88	0.53		0.85	0.50	0.86	0.78	0.66
12 (305)		0.94	0.77		0.93	0.54	0.70	0.67	0.62		1.00	0.60		0.93	0.54	0.90	0.82	0.69
14 (356)		1.00	0.81		1.00	0.63	0.74	0.70	0.64			0.76		1.00	0.63	0.97	0.88	0.75
16 (406)			0.86			0.72	0.77	0.72	0.66			0.93			0.72	1.00	0.95	0.80
18 (457)			0.90			0.81	0.80	0.75	0.68			1.00			0.81		1.00	0.85
24 (610)			1.00			1.00	0.91	0.83	0.74						1.00			0.98
30 (762)							1.00	0.92	0.80									1.00
36 (914)								1.00	0.86									
> 48 (1219)									0.98									

Table 9 - Load adjustment factors for #3 rebar in cracked concrete^{1,2,3}

#3 cracked concrete	Spacing factor in tension			Edge distance factor in tension			Spacing factor in shear ⁴			Edge distance in shear						Concrete thickness factor in shear ⁵		
										⊥ Toward edge			∥ To and away from edge					
	f_{AN}	f_{RN}	f_{AV}	f_{RV}	f_{RV}	f_{RV}	f_{RV}	f_{RV}	f_{RV}	f_{RV}	f_{RV}	f_{RV}	f_{RV}	f_{RV}	f_{RV}	f_{RV}	f_{RV}	f_{RV}
Embedment h_{ef} in. (mm)	3-3/8 (86)	4-1/2 (114)	7-1/2 (191)	3-3/8 (86)	4-1/2 (114)	7-1/2 (191)	3-3/8 (86)	4-1/2 (114)	7-1/2 (191)	3-3/8 (86)	4-1/2 (114)	7-1/2 (191)	3-3/8 (86)	4-1/2 (114)	7-1/2 (191)	3-3/8 (86)	4-1/2 (114)	7-1/2 (191)
1-3/4 (44)	n/a	n/a	n/a	0.53	0.49	0.43	n/a	n/a	n/a	0.07	0.05	0.03	0.14	0.11	0.06	n/a	n/a	n/a
1-7/8 (48)	0.59	0.57	0.54	0.55	0.50	0.44	0.53	0.53	0.52	0.08	0.06	0.03	0.16	0.12	0.07	n/a	n/a	n/a
2 (51)	0.59	0.57	0.54	0.56	0.51	0.44	0.53	0.53	0.52	0.09	0.06	0.04	0.17	0.13	0.08	n/a	n/a	n/a
3 (76)	0.64	0.61	0.57	0.68	0.60	0.49	0.55	0.54	0.53	0.16	0.12	0.07	0.32	0.24	0.14	n/a	n/a	n/a
4 (102)	0.69	0.65	0.59	0.81	0.70	0.55	0.57	0.55	0.54	0.25	0.18	0.11	0.49	0.36	0.22	n/a	n/a	n/a
4-5/8 (117)	0.72	0.67	0.60	0.90	0.76	0.58	0.58	0.56	0.54	0.31	0.23	0.14	0.61	0.45	0.27	0.55	n/a	n/a
5 (127)	0.74	0.69	0.61	0.95	0.80	0.60	0.58	0.57	0.55	0.34	0.25	0.15	0.69	0.51	0.30	0.57	n/a	n/a
5-3/4 (146)	0.77	0.71	0.63	1.00	0.88	0.64	0.59	0.58	0.55	0.42	0.31	0.19	0.85	0.63	0.38	0.61	0.55	n/a
6 (152)	0.78	0.72	0.63		0.91	0.66	0.60	0.58	0.56	0.45	0.33	0.20	0.91	0.67	0.40	0.63	0.57	n/a
7 (178)	0.83	0.76	0.66		1.00	0.72	0.61	0.59	0.57	0.57	0.42	0.25	1.00	0.84	0.50	0.68	0.61	n/a
8 (203)	0.88	0.80	0.68			0.78	0.63	0.61	0.58	0.70	0.51	0.31		1.00	0.62	0.72	0.65	n/a
8-3/4 (222)	0.91	0.82	0.69			0.83	0.64	0.62	0.58	0.80	0.59	0.35			0.70	0.76	0.68	0.58
9 (229)	0.92	0.83	0.70			0.85	0.65	0.62	0.59	0.83	0.61	0.37			0.74	0.77	0.69	0.58
10 (254)	0.97	0.87	0.72			0.91	0.66	0.63	0.60	0.97	0.72	0.43			0.86	0.81	0.73	0.62
11 (279)	1.00	0.91	0.74			0.98	0.68	0.65	0.60	1.00	0.83	0.50			0.98	0.85	0.77	0.65
12 (305)		0.94	0.77			1.00	0.70	0.66	0.61		0.94	0.57			1.00	0.89	0.80	0.68
14 (356)		1.00	0.81				0.73	0.69	0.63		1.00	0.71				0.96	0.86	0.73
16 (406)			0.86				0.76	0.71	0.65			0.87				1.00	0.92	0.78
18 (457)			0.90				0.79	0.74	0.67			1.00					0.98	0.83
24 (610)			1.00				0.89	0.82	0.73			1.00					1.00	0.96
30 (762)							0.99	0.90	0.79			1.00						1.00
36 (914)							1.00	0.98	0.84			1.00						
> 48 (1219)								1.00	0.96			1.00						

1 Linear interpolation not permitted.
 2 Shaded area with reduced edge distance is permitted provided the rebar has no installation torque.
 3 When combining multiple load adjustment factors (e.g. for a four-anchor pattern in a corner with thin concrete member) the design can become very conservative. To optimize the design, use Hilti PROFIS Anchor Design software or perform anchor calculation using design equations from ACI 318-14 Chapter 17.
 4 Spacing factor reduction in shear, f_{AV} , assumes an influence of a nearby edge. If no edge exists, then $f_{AV} = f_{AN}$.
 5 Concrete thickness reduction factor in shear, f_{HV} , assumes an influence of a nearby edge. If no edge exists, then $f_{HV} = 1.0$.

HIT-RE 500 V3 Epoxy Adhesive Anchoring System 3.2.4

Table 10 - Load adjustment factors for #4 rebar in uncracked concrete^{1,2,3}

#4 uncracked concrete	Spacing factor in tension f_{AN}			Edge distance factor in tension f_{RN}			Spacing factor in shear ⁴ f_{AV}			Edge distance in shear						Concrete thickness factor in shear ⁵ f_{HV}		
										⊥ Toward edge f_{RV}			To and away from edge f_{RV}					
	Embedment h_{ef}	4-1/2 (114)	6 (152)	10 (254)	4-1/2 (114)	6 (152)	10 (254)	4-1/2 (114)	6 (152)	10 (254)	4-1/2 (114)	6 (152)	10 (254)	4-1/2 (114)	6 (152)	10 (254)	4-1/2 (114)	6 (152)
1-3/4 (44)	n/a	n/a	n/a	0.26	0.20	0.11	n/a	n/a	n/a	0.05	0.04	0.02	0.11	0.07	0.04	n/a	n/a	n/a
2-1/2 (64)	0.59	0.57	0.54	0.29	0.22	0.13	0.53	0.53	0.52	0.09	0.06	0.04	0.18	0.13	0.08	n/a	n/a	n/a
3 (76)	0.61	0.58	0.55	0.32	0.24	0.14	0.54	0.53	0.52	0.12	0.08	0.05	0.24	0.17	0.10	n/a	n/a	n/a
4 (102)	0.64	0.61	0.57	0.37	0.28	0.16	0.55	0.54	0.53	0.18	0.13	0.08	0.37	0.26	0.15	n/a	n/a	n/a
5 (127)	0.68	0.64	0.58	0.42	0.32	0.18	0.57	0.55	0.54	0.26	0.18	0.11	0.42	0.32	0.18	n/a	n/a	n/a
5-3/4 (146)	0.70	0.66	0.60	0.47	0.35	0.20	0.58	0.56	0.54	0.32	0.22	0.13	0.47	0.35	0.20	0.56	n/a	n/a
6 (152)	0.71	0.67	0.60	0.48	0.36	0.21	0.58	0.56	0.55	0.34	0.24	0.14	0.48	0.36	0.21	0.57	n/a	n/a
7 (178)	0.75	0.69	0.62	0.55	0.40	0.24	0.59	0.57	0.55	0.42	0.30	0.18	0.55	0.40	0.24	0.61	n/a	n/a
7-1/4 (184)	0.76	0.70	0.62	0.57	0.42	0.24	0.60	0.58	0.55	0.45	0.31	0.19	0.57	0.42	0.24	0.62	0.55	n/a
8 (203)	0.79	0.72	0.63	0.63	0.46	0.27	0.61	0.58	0.56	0.52	0.36	0.22	0.63	0.46	0.27	0.66	0.58	n/a
9 (229)	0.82	0.75	0.65	0.70	0.52	0.30	0.62	0.60	0.57	0.62	0.43	0.26	0.70	0.52	0.30	0.70	0.62	n/a
10 (254)	0.86	0.78	0.67	0.78	0.57	0.34	0.63	0.61	0.58	0.72	0.51	0.30	0.78	0.57	0.34	0.73	0.65	n/a
11-1/4 (286)	0.90	0.81	0.69	0.88	0.65	0.38	0.65	0.62	0.58	0.86	0.60	0.36	0.88	0.65	0.38	0.78	0.69	0.58
12 (305)	0.93	0.83	0.70	0.94	0.69	0.40	0.66	0.63	0.59	0.95	0.67	0.40	0.94	0.69	0.40	0.80	0.71	0.60
14 (356)	1.00	0.89	0.73	1.00	0.80	0.47	0.69	0.65	0.61	1.00	0.84	0.50	1.00	0.80	0.47	0.87	0.77	0.65
16 (406)		0.94	0.77		0.92	0.54	0.72	0.67	0.62		1.00	0.61		0.92	0.54	0.93	0.82	0.69
18 (457)		1.00	0.80		1.00	0.60	0.74	0.69	0.64			0.73		1.00	0.60	0.98	0.87	0.74
20 (508)			0.83			0.67	0.77	0.71	0.65			0.86			0.67	1.00	0.92	0.78
22 (559)			0.87			0.74	0.80	0.73	0.67			0.99			0.74		0.97	0.81
24 (610)			0.90			0.81	0.82	0.75	0.68			1.00			0.81		1.00	0.85
30 (762)			1.00			1.00	0.90	0.82	0.73						1.00			0.95
36 (914)							0.98	0.88	0.77									1.00
> 48 (1219)							1.00	1.00	0.86									

3.2.4

Table 11 - Load adjustment factors for #4 rebar in cracked concrete^{1,2,3}

#4 cracked concrete	Spacing factor in tension f_{AN}			Edge distance factor in tension f_{RN}			Spacing factor in shear ⁴ f_{AV}			Edge distance in shear						Concrete thickness factor in shear ⁵ f_{HV}		
										⊥ Toward edge f_{RV}			To and away from edge f_{RV}					
	Embedment h_{ef}	4-1/2 (114)	6 (152)	10 (254)	4-1/2 (114)	6 (152)	10 (254)	4-1/2 (114)	6 (152)	10 (254)	4-1/2 (114)	6 (152)	10 (254)	4-1/2 (114)	6 (152)	10 (254)	4-1/2 (114)	6 (152)
1-3/4 (44)	n/a	n/a	n/a	0.48	0.45	0.41	n/a	n/a	n/a	0.05	0.03	0.02	0.11	0.07	0.04	n/a	n/a	n/a
2-1/2 (64)	0.59	0.57	0.54	0.55	0.50	0.44	0.53	0.53	0.52	0.09	0.06	0.03	0.18	0.12	0.07	n/a	n/a	n/a
3 (76)	0.61	0.58	0.55	0.59	0.53	0.46	0.54	0.53	0.52	0.12	0.08	0.05	0.24	0.16	0.09	n/a	n/a	n/a
4 (102)	0.64	0.61	0.57	0.68	0.60	0.49	0.55	0.54	0.53	0.18	0.12	0.07	0.37	0.24	0.14	n/a	n/a	n/a
5 (127)	0.68	0.64	0.58	0.78	0.67	0.53	0.57	0.55	0.54	0.26	0.17	0.10	0.52	0.34	0.20	n/a	n/a	n/a
5-3/4 (146)	0.70	0.66	0.60	0.86	0.73	0.56	0.58	0.56	0.54	0.32	0.21	0.12	0.64	0.41	0.24	0.56	n/a	n/a
6 (152)	0.71	0.67	0.60	0.89	0.75	0.57	0.58	0.56	0.54	0.34	0.22	0.13	0.68	0.44	0.26	0.57	n/a	n/a
7 (178)	0.75	0.69	0.62	1.00	0.83	0.62	0.59	0.57	0.55	0.43	0.28	0.16	0.86	0.56	0.33	0.62	n/a	n/a
7-1/4 (184)	0.76	0.70	0.62		0.85	0.63	0.60	0.57	0.55	0.45	0.29	0.17	0.90	0.59	0.34	0.63	0.54	n/a
8 (203)	0.79	0.72	0.63		0.91	0.66	0.61	0.58	0.56	0.52	0.34	0.20	1.00	0.68	0.40	0.66	0.57	n/a
9 (229)	0.82	0.75	0.65		1.00	0.70	0.62	0.59	0.56	0.62	0.41	0.24		0.81	0.47	0.70	0.60	n/a
10 (254)	0.86	0.78	0.67			0.75	0.64	0.60	0.57	0.73	0.47	0.28		0.95	0.56	0.74	0.64	n/a
11-1/4 (286)	0.90	0.81	0.69			0.81	0.65	0.61	0.58	0.87	0.57	0.33		1.00	0.66	0.78	0.68	0.56
12 (305)	0.93	0.83	0.70			0.85	0.66	0.62	0.59	0.96	0.62	0.36			0.73	0.81	0.70	0.58
14 (356)	1.00	0.89	0.73			0.95	0.69	0.64	0.60	1.00	0.79	0.46			0.92	0.87	0.75	0.63
16 (406)		0.94	0.77			1.00	0.72	0.66	0.61		0.96	0.56			1.00	0.93	0.81	0.67
18 (457)		1.00	0.80				0.74	0.68	0.63		1.00	0.67				0.99	0.85	0.71
20 (508)			0.83				0.77	0.70	0.64			0.79				1.00	0.90	0.75
22 (559)			0.87				0.80	0.72	0.66			0.91					0.94	0.79
24 (610)			0.90				0.82	0.74	0.67			1.00					0.99	0.83
30 (762)			1.00				0.91	0.80	0.71								1.00	0.92
36 (914)							0.99	0.87	0.76									1.00
> 48 (1219)							1.00	0.99	0.84									

1 Linear interpolation not permitted.

2 Shaded area with reduced edge distance is permitted provided the rebar has no installation torque.

3 When combining multiple load adjustment factors (e.g. for a four-anchor pattern in a corner with thin concrete member) the design can become very conservative. To optimize the design, use Hilti PROFIS Anchor Design software or perform anchor calculation using design equations from ACI 318-14 Chapter 17.

 4 Spacing factor reduction in shear, f_{AV} , assumes an influence of a nearby edge. If no edge exists, then $f_{AV} = f_{AN}$.

 5 Concrete thickness reduction factor in shear, f_{HV} , assumes an influence of a nearby edge. If no edge exists, then $f_{HV} = 1.0$.

3.2.4 HIT-RE 500 V3 Epoxy Adhesive Anchoring System

Table 12 - Load adjustment factors for #5 rebar in uncracked concrete^{1,2,3}

#5 uncracked concrete	Spacing factor in tension			Edge distance factor in tension			Spacing factor in shear ⁴			Edge distance in shear						Concrete thickness factor in shear ⁵		
										⊥ Toward edge			To and away from edge					
	f_{AN}	f_{RN}	f_{AV}	f_{RV}	f_{RV}	f_{RV}	f_{RV}	f_{RV}	f_{RV}	f_{RV}	f_{RV}	f_{RV}	f_{RV}	f_{RV}	f_{RV}	f_{HV}	f_{HV}	f_{HV}
Embedment h_{ef} in. (mm)	5-5/8 (143)	7-1/2 (191)	12-1/2 (318)	5-5/8 (143)	7-1/2 (191)	12-1/2 (318)	5-5/8 (143)	7-1/2 (191)	12-1/2 (318)	5-5/8 (143)	7-1/2 (191)	12-1/2 (318)	5-5/8 (143)	7-1/2 (191)	12-1/2 (318)	5-5/8 (143)	7-1/2 (191)	12-1/2 (318)
1-3/4 (44)	n/a	n/a	n/a	0.24	0.18	0.11	n/a	n/a	n/a	0.04	0.03	0.02	0.08	0.06	0.03	n/a	n/a	n/a
3-1/8 (79)	0.59	0.57	0.54	0.29	0.22	0.13	0.54	0.53	0.52	0.10	0.07	0.04	0.20	0.13	0.08	n/a	n/a	n/a
4 (102)	0.61	0.59	0.55	0.33	0.25	0.14	0.55	0.53	0.52	0.15	0.10	0.06	0.29	0.19	0.11	n/a	n/a	n/a
5 (127)	0.64	0.61	0.57	0.37	0.28	0.16	0.56	0.54	0.53	0.21	0.13	0.08	0.37	0.27	0.16	n/a	n/a	n/a
6 (152)	0.67	0.63	0.58	0.41	0.31	0.18	0.57	0.55	0.54	0.27	0.18	0.10	0.41	0.31	0.18	n/a	n/a	n/a
7 (178)	0.70	0.66	0.59	0.46	0.34	0.20	0.58	0.56	0.54	0.34	0.22	0.13	0.46	0.34	0.20	n/a	n/a	n/a
7-1/8 (181)	0.70	0.66	0.60	0.46	0.34	0.20	0.58	0.56	0.54	0.35	0.23	0.13	0.46	0.34	0.20	0.57	n/a	n/a
8 (203)	0.73	0.68	0.61	0.51	0.38	0.22	0.59	0.57	0.55	0.41	0.27	0.16	0.51	0.38	0.22	0.61	n/a	n/a
9 (229)	0.76	0.70	0.62	0.56	0.41	0.24	0.60	0.58	0.55	0.50	0.32	0.19	0.56	0.41	0.24	0.65	0.56	n/a
10 (254)	0.79	0.72	0.63	0.63	0.46	0.27	0.62	0.59	0.56	0.58	0.38	0.22	0.63	0.46	0.27	0.68	0.59	n/a
11 (279)	0.82	0.74	0.65	0.69	0.51	0.30	0.63	0.60	0.57	0.67	0.43	0.25	0.69	0.51	0.30	0.71	0.62	n/a
12 (305)	0.84	0.77	0.66	0.75	0.55	0.32	0.64	0.60	0.57	0.76	0.50	0.29	0.75	0.55	0.32	0.75	0.65	n/a
14 (356)	0.90	0.81	0.69	0.88	0.64	0.38	0.66	0.62	0.59	0.96	0.62	0.36	0.88	0.64	0.38	0.81	0.70	0.58
16 (406)	0.96	0.86	0.71	1.00	0.74	0.43	0.69	0.64	0.60	1.00	0.76	0.45	1.00	0.74	0.43	0.86	0.75	0.62
18 (457)	1.00	0.90	0.74		0.83	0.49	0.71	0.66	0.61		0.91	0.53		0.83	0.49	0.91	0.79	0.66
20 (508)		0.94	0.77		0.92	0.54	0.73	0.67	0.62		1.00	0.62		0.92	0.54	0.96	0.83	0.70
22 (559)		0.99	0.79		1.00	0.59	0.75	0.69	0.63			0.72		1.00	0.59	1.00	0.87	0.73
24 (610)		1.00	0.82			0.65	0.78	0.71	0.65			0.82			0.65		0.91	0.76
26 (660)			0.85			0.70	0.80	0.73	0.66			0.92			0.70		0.95	0.79
28 (711)			0.87			0.75	0.82	0.74	0.67			1.00			0.75		0.99	0.82
30 (762)			0.90			0.81	0.85	0.76	0.68						0.81		1.00	0.85
36 (914)			0.98			0.97	0.92	0.81	0.72						0.97			0.94
> 48 (1219)			1.00			1.00	1.00	0.92	0.79						1.00			1.00

Table 13 - Load adjustment factors for #5 rebar in cracked concrete^{1,2,3}

#5 cracked concrete	Spacing factor in tension			Edge distance factor in tension			Spacing factor in shear ⁴			Edge distance in shear						Concrete thickness factor in shear ⁵		
										⊥ Toward edge			To and away from edge					
	f_{AN}	f_{RN}	f_{AV}	f_{RV}	f_{RV}	f_{RV}	f_{RV}	f_{RV}	f_{RV}	f_{RV}	f_{RV}	f_{RV}	f_{RV}	f_{RV}	f_{RV}	f_{RV}	f_{RV}	f_{RV}
Embedment h_{ef} in. (mm)	5-5/8 (143)	7-1/2 (191)	12-1/2 (318)	5-5/8 (143)	7-1/2 (191)	12-1/2 (318)	5-5/8 (143)	7-1/2 (191)	12-1/2 (318)	5-5/8 (143)	7-1/2 (191)	12-1/2 (318)	5-5/8 (143)	7-1/2 (191)	12-1/2 (318)	5-5/8 (143)	7-1/2 (191)	12-1/2 (318)
1-3/4 (44)	n/a	n/a	n/a	0.46	0.43	0.40	n/a	n/a	n/a	0.04	0.03	0.01	0.09	0.06	0.03	n/a	n/a	n/a
3-1/8 (79)	0.59	0.57	0.54	0.55	0.50	0.44	0.54	0.53	0.52	0.10	0.07	0.03	0.20	0.13	0.07	n/a	n/a	n/a
4 (102)	0.61	0.59	0.55	0.61	0.55	0.46	0.55	0.53	0.52	0.15	0.10	0.05	0.30	0.19	0.10	n/a	n/a	n/a
5 (127)	0.64	0.61	0.57	0.69	0.60	0.49	0.56	0.54	0.53	0.21	0.13	0.07	0.41	0.27	0.14	n/a	n/a	n/a
6 (152)	0.67	0.63	0.58	0.77	0.66	0.53	0.57	0.55	0.53	0.27	0.18	0.09	0.54	0.35	0.18	n/a	n/a	n/a
7 (178)	0.70	0.66	0.59	0.85	0.72	0.56	0.58	0.56	0.54	0.34	0.22	0.11	0.68	0.44	0.23	n/a	n/a	n/a
7-1/8 (181)	0.70	0.66	0.60	0.86	0.73	0.56	0.58	0.56	0.54	0.35	0.23	0.12	0.70	0.46	0.23	0.58	n/a	n/a
8 (203)	0.73	0.68	0.61	0.93	0.78	0.59	0.59	0.57	0.54	0.42	0.27	0.14	0.84	0.54	0.28	0.61	n/a	n/a
9 (229)	0.76	0.70	0.62	1.00	0.85	0.62	0.60	0.58	0.55	0.50	0.32	0.17	1.00	0.65	0.33	0.65	0.56	n/a
10 (254)	0.79	0.72	0.63		0.91	0.66	0.62	0.59	0.56	0.58	0.38	0.19		0.76	0.39	0.68	0.59	n/a
11 (279)	0.82	0.74	0.65		0.98	0.69	0.63	0.60	0.56	0.67	0.44	0.22		0.88	0.45	0.72	0.62	n/a
12 (305)	0.84	0.77	0.66		1.00	0.73	0.64	0.60	0.57	0.77	0.50	0.26		1.00	0.51	0.75	0.65	n/a
14 (356)	0.90	0.81	0.69			0.81	0.66	0.62	0.58	0.97	0.63	0.32			0.64	0.81	0.70	0.56
16 (406)	0.96	0.86	0.71			0.89	0.69	0.64	0.59	1.00	0.77	0.39			0.79	0.86	0.75	0.60
18 (457)	1.00	0.90	0.74			0.97	0.71	0.66	0.60		0.92	0.47			0.94	0.92	0.79	0.63
20 (508)		0.94	0.77			1.00	0.73	0.67	0.61		1.00	0.55			1.00	0.97	0.84	0.67
22 (559)		0.99	0.79				0.76	0.69	0.62			0.63			1.00	0.88	0.70	
24 (610)		1.00	0.82				0.78	0.71	0.63			0.72				0.92	0.73	
26 (660)			0.85				0.80	0.73	0.65			0.81				0.95	0.76	
28 (711)			0.87				0.83	0.74	0.66			0.91				0.99	0.79	
30 (762)			0.90				0.85	0.76	0.67			1.00				1.00	0.82	
36 (914)			0.98				0.92	0.81	0.70									0.90
> 48 (1219)			1.00				1.00	0.92	0.77									1.00

1 Linear interpolation not permitted.
 2 Shaded area with reduced edge distance is permitted provided the rebar has no installation torque.
 3 When combining multiple load adjustment factors (e.g. for a four-anchor pattern in a corner with thin concrete member) the design can become very conservative. To optimize the design, use Hilti PROFIS Anchor Design software or perform anchor calculation using design equations from ACI 318-14 Chapter 17.
 4 Spacing factor reduction in shear, f_{AV} , assumes an influence of a nearby edge. If no edge exists, then $f_{AV} = f_{AN}$.
 5 Concrete thickness reduction factor in shear, f_{HV} , assumes an influence of a nearby edge. If no edge exists, then $f_{HV} = 1.0$.

HIT-RE 500 V3 Epoxy Adhesive Anchoring System 3.2.4

Table 14 - Load adjustment factors for #6 rebar in uncracked concrete^{1,2,3}

#6 uncracked concrete	Spacing factor in tension f_{AN}			Edge distance factor in tension f_{RN}			Spacing factor in shear ⁴ f_{AV}			Edge distance in shear						Concrete thickness factor in shear ⁵ f_{HV}		
										⊥ Toward edge f_{RV}			To and away from edge f_{RV}					
	Embedment h_{ef}	6-3/4 (171)	9 (229)	15 (381)	6-3/4 (171)	9 (229)	15 (381)	6-3/4 (171)	9 (229)	15 (381)	6-3/4 (171)	9 (229)	15 (381)	6-3/4 (171)	9 (229)	15 (381)	6-3/4 (171)	9 (229)
1-3/4 (44)	n/a	n/a	n/a	0.24	0.18	0.10	n/a	n/a	n/a	0.03	0.02	0.01	0.07	0.05	0.02	n/a	n/a	n/a
3-3/4 (95)	0.59	0.57	0.54	0.30	0.22	0.13	0.54	0.53	0.52	0.11	0.07	0.04	0.22	0.14	0.08	n/a	n/a	n/a
4 (102)	0.60	0.57	0.54	0.31	0.23	0.13	0.54	0.53	0.52	0.12	0.08	0.04	0.24	0.16	0.08	n/a	n/a	n/a
5 (127)	0.62	0.59	0.56	0.34	0.25	0.15	0.55	0.54	0.53	0.17	0.11	0.06	0.33	0.22	0.12	n/a	n/a	n/a
6 (152)	0.64	0.61	0.57	0.38	0.28	0.16	0.56	0.55	0.53	0.22	0.14	0.08	0.38	0.28	0.16	n/a	n/a	n/a
7 (178)	0.67	0.63	0.58	0.41	0.30	0.18	0.57	0.55	0.54	0.28	0.18	0.10	0.41	0.30	0.18	n/a	n/a	n/a
8 (203)	0.69	0.65	0.59	0.45	0.33	0.19	0.58	0.56	0.54	0.34	0.22	0.12	0.45	0.33	0.19	n/a	n/a	n/a
8-1/2 (216)	0.70	0.66	0.59	0.47	0.34	0.20	0.59	0.56	0.54	0.37	0.24	0.13	0.47	0.34	0.20	0.59	n/a	n/a
9 (229)	0.72	0.67	0.60	0.49	0.36	0.21	0.59	0.57	0.55	0.40	0.26	0.14	0.49	0.36	0.21	0.60	n/a	n/a
10 (254)	0.74	0.69	0.61	0.53	0.39	0.23	0.60	0.58	0.55	0.47	0.31	0.17	0.53	0.39	0.23	0.64	n/a	n/a
10-3/4 (273)	0.76	0.70	0.62	0.57	0.41	0.24	0.61	0.58	0.55	0.53	0.34	0.19	0.57	0.41	0.24	0.66	0.57	n/a
12 (305)	0.79	0.72	0.63	0.64	0.46	0.27	0.62	0.59	0.56	0.62	0.40	0.22	0.64	0.46	0.27	0.70	0.60	n/a
14 (356)	0.84	0.76	0.66	0.74	0.54	0.32	0.64	0.61	0.57	0.78	0.51	0.28	0.74	0.54	0.32	0.75	0.65	n/a
16 (406)	0.89	0.80	0.68	0.85	0.62	0.36	0.66	0.62	0.58	0.96	0.62	0.34	0.85	0.62	0.36	0.80	0.70	n/a
16-3/4 (425)	0.90	0.81	0.69	0.89	0.65	0.38	0.67	0.63	0.58	1.00	0.67	0.36	0.89	0.65	0.38	0.82	0.71	0.58
18 (457)	0.93	0.83	0.70	0.96	0.69	0.41	0.68	0.64	0.59		0.74	0.40	0.96	0.69	0.41	0.85	0.74	0.60
20 (508)	0.98	0.87	0.72	1.00	0.77	0.45	0.70	0.65	0.60		0.87	0.47	1.00	0.77	0.45	0.90	0.78	0.64
22 (559)	1.00	0.91	0.74		0.85	0.50	0.72	0.67	0.61		1.00	0.54		0.85	0.50	0.94	0.82	0.67
24 (610)		0.94	0.77		0.93	0.54	0.74	0.68	0.62			0.62		0.93	0.54	0.99	0.85	0.70
26 (660)		0.98	0.79		1.00	0.59	0.76	0.70	0.63			0.70		1.00	0.59	1.00	0.89	0.72
28 (711)		1.00	0.81			0.63	0.78	0.71	0.64			0.78			0.63		0.92	0.75
30 (762)			0.83			0.68	0.80	0.73	0.65			0.87			0.68		0.95	0.78
36 (914)			0.90			0.81	0.86	0.77	0.68			1.00			0.81		1.00	0.85
> 48 (1219)			1.00			1.00	0.99	0.86	0.74						1.00			0.98

3.2.4
Table 15 - Load adjustment factors for #6 rebar in cracked concrete^{1,2,3}

#6 cracked concrete	Spacing factor in tension f_{AN}			Edge distance factor in tension f_{RN}			Spacing factor in shear ⁴ f_{AV}			Edge distance in shear						Concrete thickness factor in shear ⁵ f_{HV}		
										⊥ Toward edge f_{RV}			To and away from edge f_{RV}					
	Embedment h_{ef}	6-3/4 (171)	9 (229)	15 (381)	6-3/4 (171)	9 (229)	15 (381)	6-3/4 (171)	9 (229)	15 (381)	6-3/4 (171)	9 (229)	15 (381)	6-3/4 (171)	9 (229)	15 (381)	6-3/4 (171)	9 (229)
1-3/4 (44)	n/a	n/a	n/a	0.44	0.42	0.39	n/a	n/a	n/a	0.03	0.02	0.01	0.07	0.05	0.02	n/a	n/a	n/a
3-3/4 (95)	0.59	0.57	0.54	0.55	0.50	0.44	0.54	0.53	0.52	0.11	0.07	0.03	0.22	0.14	0.07	n/a	n/a	n/a
4 (102)	0.60	0.57	0.54	0.57	0.51	0.44	0.54	0.53	0.52	0.12	0.08	0.04	0.24	0.16	0.07	n/a	n/a	n/a
5 (127)	0.62	0.59	0.56	0.63	0.56	0.47	0.55	0.54	0.52	0.17	0.11	0.05	0.34	0.22	0.10	n/a	n/a	n/a
6 (152)	0.64	0.61	0.57	0.69	0.60	0.49	0.56	0.55	0.53	0.22	0.14	0.07	0.44	0.29	0.13	n/a	n/a	n/a
7 (178)	0.67	0.63	0.58	0.76	0.65	0.52	0.57	0.55	0.53	0.28	0.18	0.08	0.56	0.36	0.17	n/a	n/a	n/a
8 (203)	0.69	0.65	0.59	0.82	0.70	0.55	0.58	0.56	0.54	0.34	0.22	0.10	0.68	0.44	0.21	n/a	n/a	n/a
8-1/2 (216)	0.70	0.66	0.59	0.86	0.72	0.56	0.59	0.56	0.54	0.37	0.24	0.11	0.75	0.49	0.23	0.59	n/a	n/a
9 (229)	0.72	0.67	0.60	0.90	0.75	0.57	0.59	0.57	0.54	0.41	0.26	0.12	0.82	0.53	0.25	0.61	n/a	n/a
10 (254)	0.74	0.69	0.61	0.97	0.80	0.60	0.60	0.58	0.55	0.48	0.31	0.14	0.95	0.62	0.29	0.64	n/a	n/a
10-3/4 (273)	0.76	0.70	0.62	1.00	0.84	0.62	0.61	0.58	0.55	0.53	0.35	0.16	1.00	0.69	0.32	0.66	0.57	n/a
12 (305)	0.79	0.72	0.63		0.91	0.66	0.62	0.59	0.55	0.63	0.41	0.19		0.82	0.38	0.70	0.61	n/a
14 (356)	0.84	0.76	0.66		1.00	0.72	0.64	0.61	0.56	0.79	0.51	0.24		1.00	0.48	0.76	0.65	n/a
16 (406)	0.89	0.80	0.68			0.78	0.66	0.62	0.57	0.97	0.63	0.29			0.58	0.81	0.70	n/a
16-3/4 (425)	0.90	0.81	0.69			0.81	0.67	0.63	0.58	1.00	0.67	0.31			0.62	0.83	0.72	0.55
18 (457)	0.93	0.83	0.70			0.85	0.68	0.64	0.58		0.75	0.35			0.70	0.86	0.74	0.57
20 (508)	0.98	0.87	0.72			0.91	0.70	0.65	0.59		0.88	0.41			0.82	0.90	0.78	0.61
22 (559)	1.00	0.91	0.74			0.98	0.72	0.67	0.60		1.00	0.47			0.94	0.95	0.82	0.63
24 (610)		0.94	0.77			1.00	0.74	0.68	0.61			0.54			1.00	0.99	0.86	0.66
26 (660)		0.98	0.79				0.76	0.70	0.62			0.60			1.00	0.89	0.69	
28 (711)		1.00	0.81				0.79	0.71	0.63			0.68				0.92	0.72	
30 (762)			0.83				0.81	0.73	0.64			0.75				0.96	0.74	
36 (914)			0.90				0.87	0.77	0.66			0.98				1.00	0.81	
> 48 (1219)			1.00				0.99	0.87	0.72			1.00						0.94

1 Linear interpolation not permitted.

2 Shaded area with reduced edge distance is permitted provided the rebar has no installation torque.

3 When combining multiple load adjustment factors (e.g. for a four-anchor pattern in a corner with thin concrete member) the design can become very conservative. To optimize the design, use Hilti PROFIS Anchor Design software or perform anchor calculation using design equations from ACI 318 Chapter 17.

 4 Spacing factor reduction in shear, f_{AV} , assumes an influence of a nearby edge. If no edge exists, then $f_{AV} = f_{AN}$.

 5 Concrete thickness reduction factor in shear, f_{HV} , assumes an influence of a nearby edge. If no edge exists, then $f_{HV} = 1.0$.

3.2.4 HIT-RE 500 V3 Epoxy Adhesive Anchoring System

Table 16 - Load adjustment factors for #7 rebar in uncracked concrete^{1,2,3}

#7 uncracked concrete	Embedment h_{ef} in. (mm)	Spacing factor in tension			Edge distance factor in tension			Spacing factor in shear ⁴			Edge distance in shear						Concrete thickness factor in shear ⁵		
		f_{AN}			f_{RN}			f_{AV}			f_{RV} \perp Toward edge			f_{RV} \parallel To and away from edge			f_{HV}		
		7-7/8 (200)	10-1/2 (267)	17-1/2 (445)	7-7/8 (200)	10-1/2 (267)	17-1/2 (445)	7-7/8 (200)	10-1/2 (267)	17-1/2 (445)	7-7/8 (200)	10-1/2 (267)	17-1/2 (445)	7-7/8 (200)	10-1/2 (267)	17-1/2 (445)	7-7/8 (200)	10-1/2 (267)	17-1/2 (445)
1-3/4 (44)	n/a	n/a	n/a	0.24	0.17	0.10	n/a	n/a	n/a	0.03	0.02	0.01	0.05	0.04	0.02	n/a	n/a	n/a	
4-3/8 (111)	0.59	0.57	0.54	0.31	0.22	0.13	0.54	0.53	0.52	0.11	0.07	0.04	0.22	0.14	0.07	n/a	n/a	n/a	
5 (127)	0.60	0.58	0.55	0.33	0.23	0.14	0.54	0.53	0.52	0.13	0.09	0.04	0.27	0.17	0.09	n/a	n/a	n/a	
6 (152)	0.62	0.60	0.56	0.36	0.25	0.15	0.55	0.54	0.52	0.17	0.11	0.06	0.35	0.23	0.12	n/a	n/a	n/a	
7 (178)	0.65	0.61	0.57	0.39	0.28	0.16	0.56	0.55	0.53	0.22	0.14	0.07	0.39	0.28	0.15	n/a	n/a	n/a	
8 (203)	0.67	0.63	0.58	0.42	0.30	0.18	0.57	0.55	0.53	0.27	0.17	0.09	0.42	0.30	0.18	n/a	n/a	n/a	
9 (229)	0.69	0.64	0.59	0.45	0.32	0.19	0.58	0.56	0.54	0.32	0.21	0.11	0.45	0.32	0.19	n/a	n/a	n/a	
9-7/8 (251)	0.71	0.66	0.59	0.48	0.34	0.20	0.59	0.56	0.54	0.37	0.24	0.12	0.48	0.34	0.20	0.59	n/a	n/a	
10 (254)	0.71	0.66	0.60	0.49	0.35	0.20	0.59	0.57	0.54	0.38	0.24	0.12	0.49	0.35	0.20	0.59	n/a	n/a	
11 (279)	0.73	0.67	0.60	0.52	0.37	0.22	0.60	0.57	0.55	0.43	0.28	0.14	0.52	0.37	0.22	0.62	n/a	n/a	
12 (305)	0.75	0.69	0.61	0.56	0.40	0.23	0.60	0.58	0.55	0.49	0.32	0.16	0.56	0.40	0.23	0.65	n/a	n/a	
12-1/2 (318)	0.76	0.70	0.62	0.59	0.41	0.24	0.61	0.58	0.55	0.52	0.34	0.17	0.59	0.41	0.24	0.66	0.57	n/a	
14 (356)	0.79	0.72	0.63	0.66	0.46	0.27	0.62	0.59	0.56	0.62	0.40	0.21	0.66	0.46	0.27	0.70	0.60	n/a	
16 (406)	0.83	0.75	0.65	0.75	0.53	0.31	0.64	0.60	0.57	0.76	0.49	0.25	0.75	0.53	0.31	0.75	0.65	n/a	
18 (457)	0.87	0.79	0.67	0.84	0.60	0.35	0.66	0.62	0.57	0.91	0.59	0.30	0.84	0.60	0.35	0.79	0.68	n/a	
19-1/2 (495)	0.91	0.81	0.69	0.92	0.65	0.38	0.67	0.63	0.58	1.00	0.66	0.34	0.92	0.65	0.38	0.82	0.71	0.57	
20 (508)	0.92	0.82	0.69	0.94	0.66	0.39	0.67	0.63	0.58		0.69	0.35	0.94	0.66	0.39	0.83	0.72	0.58	
22 (559)	0.96	0.85	0.71	1.00	0.73	0.43	0.69	0.64	0.59		0.80	0.40	1.00	0.73	0.43	0.87	0.76	0.60	
24 (610)	1.00	0.88	0.73		0.80	0.47	0.71	0.66	0.60		0.91	0.46		0.80	0.47	0.91	0.79	0.63	
26 (660)		0.91	0.75		0.86	0.51	0.73	0.67	0.61		1.00	0.52		0.86	0.51	0.95	0.82	0.66	
28 (711)		0.94	0.77		0.93	0.54	0.74	0.68	0.62			0.58		0.93	0.54	0.99	0.85	0.68	
30 (762)		0.98	0.79		1.00	0.58	0.76	0.70	0.62			0.64		1.00	0.58	1.00	0.88	0.71	
36 (914)		1.00	0.84			0.70	0.81	0.73	0.65			0.85			0.70		0.97	0.77	
> 48 (1219)			0.96			0.93	0.92	0.81	0.70			1.00			0.93		1.00	0.89	

Table 17 - Load adjustment factors for #7 rebar in cracked concrete^{1,2,3}

#7 cracked concrete	Embedment h_{ef} in. (mm)	Spacing factor in tension			Edge distance factor in tension			Spacing factor in shear ⁴			Edge distance in shear						Concrete thickness factor in shear ⁵		
		f_{AN}			f_{RN}			f_{AV}			f_{RV} \perp Toward edge			f_{RV} \parallel To and away from edge			f_{HV}		
		7-7/8 (200)	10-1/2 (267)	17-1/2 (445)	7-7/8 (200)	10-1/2 (267)	17-1/2 (445)	7-7/8 (200)	10-1/2 (267)	17-1/2 (445)	7-7/8 (200)	10-1/2 (267)	17-1/2 (445)	7-7/8 (200)	10-1/2 (267)	17-1/2 (445)	7-7/8 (200)	10-1/2 (267)	17-1/2 (445)
1-3/4 (44)	n/a	n/a	n/a	0.43	0.41	0.38	n/a	n/a	n/a	0.03	0.02	0.01	0.06	0.04	0.02	n/a	n/a	n/a	
4-3/8 (111)	0.59	0.57	0.54	0.55	0.50	0.44	0.54	0.53	0.52	0.11	0.07	0.03	0.22	0.14	0.07	n/a	n/a	n/a	
5 (127)	0.60	0.58	0.55	0.58	0.52	0.45	0.54	0.53	0.52	0.13	0.09	0.04	0.27	0.17	0.08	n/a	n/a	n/a	
6 (152)	0.62	0.60	0.56	0.64	0.56	0.47	0.55	0.54	0.52	0.18	0.11	0.05	0.35	0.23	0.11	n/a	n/a	n/a	
7 (178)	0.65	0.61	0.57	0.69	0.60	0.49	0.56	0.55	0.53	0.22	0.14	0.07	0.44	0.29	0.13	n/a	n/a	n/a	
8 (203)	0.67	0.63	0.58	0.75	0.64	0.52	0.57	0.55	0.53	0.27	0.18	0.08	0.54	0.35	0.16	n/a	n/a	n/a	
9 (229)	0.69	0.64	0.59	0.81	0.68	0.54	0.58	0.56	0.54	0.32	0.21	0.10	0.65	0.42	0.20	n/a	n/a	n/a	
9-7/8 (251)	0.71	0.66	0.59	0.86	0.72	0.56	0.59	0.56	0.54	0.37	0.24	0.11	0.74	0.48	0.22	0.59	n/a	n/a	
10 (254)	0.71	0.66	0.60	0.87	0.73	0.56	0.59	0.57	0.54	0.38	0.25	0.11	0.76	0.49	0.23	0.59	n/a	n/a	
11 (279)	0.73	0.67	0.60	0.93	0.77	0.59	0.60	0.57	0.54	0.44	0.28	0.13	0.87	0.57	0.26	0.62	n/a	n/a	
12 (305)	0.75	0.69	0.61	1.00	0.82	0.61	0.60	0.58	0.55	0.50	0.32	0.15	1.00	0.65	0.30	0.65	n/a	n/a	
12-1/2 (318)	0.76	0.70	0.62		0.84	0.62	0.61	0.58	0.55	0.53	0.34	0.16		0.69	0.32	0.66	0.57	n/a	
14 (356)	0.79	0.72	0.63		0.91	0.66	0.62	0.59	0.55	0.63	0.41	0.19		0.82	0.38	0.70	0.61	n/a	
16 (406)	0.83	0.75	0.65		1.00	0.71	0.64	0.60	0.56	0.77	0.50	0.23		1.00	0.46	0.75	0.65	n/a	
18 (457)	0.87	0.79	0.67			0.76	0.66	0.62	0.57	0.91	0.59	0.28			0.55	0.79	0.69	n/a	
19-1/2 (495)	0.91	0.81	0.69			0.80	0.67	0.63	0.58	1.00	0.67	0.31			0.62	0.82	0.71	0.55	
20 (508)	0.92	0.82	0.69			0.82	0.67	0.63	0.58		0.70	0.32			0.65	0.84	0.72	0.56	
22 (559)	0.96	0.85	0.71			0.87	0.69	0.64	0.59		0.80	0.37			0.75	0.88	0.76	0.59	
24 (610)	1.00	0.88	0.73			0.93	0.71	0.66	0.59		0.91	0.43			0.85	0.92	0.79	0.61	
26 (660)		0.91	0.75			0.99	0.73	0.67	0.60		1.00	0.48			0.96	0.95	0.82	0.64	
28 (711)		0.94	0.77			1.00	0.74	0.68	0.61			0.54			1.00	0.99	0.86	0.66	
30 (762)		0.98	0.79				0.76	0.70	0.62			0.59			1.00	0.89	0.69		
36 (914)		1.00	0.84				0.81	0.74	0.64			0.78				0.97	0.75		
> 48 (1219)			0.96				0.92	0.81	0.69			1.00				1.00	0.87		

1 Linear interpolation not permitted.

2 Shaded area with reduced edge distance is permitted provided the rebar has no installation torque.

3 When combining multiple load adjustment factors (e.g. for a four-anchor pattern in a corner with thin concrete member) the design can become very conservative. To optimize the design, use Hilti PROFIS Anchor Design software or perform anchor calculation using design equations from ACI 318-14 Chapter 17.

4 Spacing factor reduction in shear, f_{AV} , assumes an influence of a nearby edge. If no edge exists, then $f_{AV} = f_{AN}$.

5 Concrete thickness reduction factor in shear, f_{HV} , assumes an influence of a nearby edge. If no edge exists, then $f_{HV} = 1.0$.

HIT-RE 500 V3 Epoxy Adhesive Anchoring System 3.2.4

Table 18 - Load adjustment factors for #8 rebar in uncracked concrete^{1,2,3}

#8 uncracked concrete	Spacing factor in tension f_{AN}			Edge distance factor in tension f_{RN}			Spacing factor in shear ⁴ f_{AV}			Edge distance in shear						Concrete thickness factor in shear ⁵ f_{HV}				
										⊥ Toward edge f_{RV}			To and away from edge f_{RV}							
	Embedment h_{ef}	in. (mm)	9 (229)	12 (305)	20 (508)	9 (229)	12 (305)	20 (508)	9 (229)	12 (305)	20 (508)	9 (229)	12 (305)	20 (508)	9 (229)	12 (305)	20 (508)	9 (229)	12 (305)	20 (508)
Spacing (s) / edge distance (c_e) / concrete thickness (h), - in. (mm)	1-3/4	(44)	n/a	n/a	n/a	0.24	0.17	0.10	n/a	n/a	n/a	0.02	0.01	0.01	0.05	0.03	0.01	n/a	n/a	n/a
	5	(127)	0.59	0.57	0.54	0.32	0.22	0.13	0.54	0.53	0.52	0.11	0.07	0.03	0.22	0.14	0.07	n/a	n/a	n/a
	6	(152)	0.61	0.58	0.55	0.34	0.24	0.14	0.55	0.53	0.52	0.14	0.09	0.04	0.29	0.19	0.09	n/a	n/a	n/a
	7	(178)	0.63	0.60	0.56	0.37	0.26	0.15	0.55	0.54	0.52	0.18	0.12	0.06	0.36	0.23	0.11	n/a	n/a	n/a
	8	(203)	0.65	0.61	0.57	0.40	0.28	0.16	0.56	0.55	0.53	0.22	0.14	0.07	0.40	0.28	0.14	n/a	n/a	n/a
	9	(229)	0.67	0.63	0.58	0.43	0.30	0.17	0.57	0.55	0.53	0.26	0.17	0.08	0.43	0.30	0.17	n/a	n/a	n/a
	10	(254)	0.68	0.64	0.58	0.46	0.32	0.19	0.58	0.56	0.54	0.31	0.20	0.10	0.46	0.32	0.19	n/a	n/a	n/a
	11	(279)	0.70	0.65	0.59	0.49	0.34	0.20	0.58	0.56	0.54	0.35	0.23	0.11	0.49	0.34	0.20	n/a	n/a	n/a
	11-1/4	(286)	0.71	0.66	0.59	0.50	0.34	0.20	0.59	0.56	0.54	0.37	0.24	0.12	0.50	0.34	0.20	0.58	n/a	n/a
	12	(305)	0.72	0.67	0.60	0.52	0.36	0.21	0.59	0.57	0.54	0.40	0.26	0.13	0.52	0.36	0.21	0.60	n/a	n/a
	13	(330)	0.74	0.68	0.61	0.55	0.38	0.22	0.60	0.57	0.55	0.46	0.30	0.14	0.55	0.38	0.22	0.63	n/a	n/a
	14	(356)	0.76	0.69	0.62	0.59	0.41	0.24	0.61	0.58	0.55	0.51	0.33	0.16	0.59	0.41	0.24	0.65	n/a	n/a
	14-1/4	(362)	0.76	0.70	0.62	0.60	0.42	0.24	0.61	0.58	0.55	0.52	0.34	0.16	0.60	0.42	0.24	0.66	0.57	n/a
	16	(406)	0.79	0.72	0.63	0.67	0.47	0.27	0.62	0.59	0.56	0.62	0.40	0.20	0.67	0.47	0.27	0.70	0.60	n/a
	18	(457)	0.83	0.75	0.65	0.76	0.53	0.31	0.64	0.60	0.56	0.74	0.48	0.23	0.76	0.53	0.31	0.74	0.64	n/a
	20	(508)	0.87	0.78	0.67	0.84	0.58	0.34	0.65	0.61	0.57	0.87	0.56	0.27	0.84	0.58	0.34	0.78	0.67	n/a
	22	(559)	0.90	0.81	0.68	0.93	0.64	0.38	0.67	0.63	0.58	1.00	0.65	0.32	0.93	0.64	0.38	0.82	0.71	n/a
	22-1/4	(565)	0.91	0.81	0.69	0.94	0.65	0.38	0.67	0.63	0.58		0.66	0.32	0.94	0.65	0.38	0.82	0.71	0.56
	24	(610)	0.94	0.83	0.70	1.00	0.70	0.41	0.68	0.64	0.58		0.74	0.36	1.00	0.70	0.41	0.85	0.74	0.58
	26	(660)	0.98	0.86	0.72		0.76	0.45	0.70	0.65	0.59		0.84	0.41		0.76	0.45	0.89	0.77	0.60
28	(711)	1.00	0.89	0.73		0.82	0.48	0.71	0.66	0.60		0.94	0.45		0.82	0.48	0.92	0.80	0.63	
30	(762)		0.92	0.75		0.88	0.51	0.73	0.67	0.61		1.00	0.50		0.88	0.51	0.95	0.83	0.65	
36	(914)		1.00	0.80		1.00	0.62	0.77	0.70	0.63			0.66		1.00	0.62	1.00	0.91	0.71	
> 48	(1219)			0.90				0.82	0.86	0.77	0.67			1.00			0.82		0.82	

3.2.4
Table 19 - Load adjustment factors for #8 rebar in cracked concrete^{1,2,3}

#8 cracked concrete	Spacing factor in tension f_{AN}			Edge distance factor in tension f_{RN}			Spacing factor in shear ⁴ f_{AV}			Edge distance in shear						Concrete thickness factor in shear ⁵ f_{HV}				
										⊥ Toward edge f_{RV}			To and away from edge f_{RV}							
	Embedment h_{ef}	in. (mm)	9 (229)	12 (305)	20 (508)	9 (229)	12 (305)	20 (508)	9 (229)	12 (305)	20 (508)	9 (229)	12 (305)	20 (508)	9 (229)	12 (305)	20 (508)	9 (229)	12 (305)	20 (508)
Spacing (s) / edge distance (c_e) / concrete thickness (h), - in. (mm)	1-3/4	(44)	n/a	n/a	n/a	0.42	0.40	0.38	n/a	n/a	n/a	0.02	0.01	0.01	0.05	0.03	0.01	n/a	n/a	n/a
	5	(127)	0.59	0.57	0.54	0.55	0.50	0.44	0.54	0.53	0.52	0.11	0.07	0.03	0.22	0.14	0.07	n/a	n/a	n/a
	6	(152)	0.61	0.58	0.55	0.60	0.53	0.46	0.55	0.53	0.52	0.14	0.09	0.04	0.29	0.19	0.09	n/a	n/a	n/a
	7	(178)	0.63	0.60	0.56	0.65	0.57	0.47	0.55	0.54	0.52	0.18	0.12	0.05	0.36	0.24	0.11	n/a	n/a	n/a
	8	(203)	0.65	0.61	0.57	0.70	0.60	0.49	0.56	0.55	0.53	0.22	0.14	0.07	0.44	0.29	0.13	n/a	n/a	n/a
	9	(229)	0.67	0.63	0.58	0.75	0.64	0.51	0.57	0.55	0.53	0.26	0.17	0.08	0.53	0.34	0.16	n/a	n/a	n/a
	10	(254)	0.68	0.64	0.58	0.80	0.67	0.53	0.58	0.56	0.53	0.31	0.20	0.09	0.62	0.40	0.19	n/a	n/a	n/a
	11	(279)	0.70	0.65	0.59	0.85	0.71	0.55	0.58	0.56	0.54	0.36	0.23	0.11	0.72	0.46	0.22	n/a	n/a	n/a
	11-1/4	(286)	0.71	0.66	0.59	0.87	0.72	0.56	0.59	0.56	0.54	0.37	0.24	0.11	0.74	0.48	0.22	0.59	n/a	n/a
	12	(305)	0.72	0.67	0.60	0.91	0.75	0.57	0.59	0.57	0.54	0.41	0.26	0.12	0.82	0.53	0.25	0.61	n/a	n/a
	13	(330)	0.74	0.68	0.61	0.96	0.79	0.59	0.60	0.57	0.54	0.46	0.30	0.14	0.92	0.60	0.28	0.63	n/a	n/a
	14	(356)	0.76	0.69	0.62	1.00	0.83	0.62	0.61	0.58	0.55	0.51	0.33	0.16	1.00	0.67	0.31	0.65	n/a	n/a
	14-1/4	(362)	0.76	0.70	0.62		0.84	0.62	0.61	0.58	0.55	0.53	0.34	0.16		0.69	0.32	0.66	0.57	n/a
	16	(406)	0.79	0.72	0.63		0.91	0.66	0.62	0.59	0.55	0.63	0.41	0.19		0.82	0.38	0.70	0.61	n/a
	18	(457)	0.83	0.75	0.65		1.00	0.70	0.64	0.60	0.56	0.75	0.49	0.23		0.97	0.45	0.74	0.64	n/a
	20	(508)	0.87	0.78	0.67			0.75	0.65	0.61	0.57	0.88	0.57	0.26		1.00	0.53	0.78	0.68	n/a
	22	(559)	0.90	0.81	0.68			0.80	0.67	0.63	0.58	1.00	0.66	0.31			0.61	0.82	0.71	n/a
	22-1/4	(565)	0.91	0.81	0.69			0.80	0.67	0.63	0.58		0.67	0.31			0.62	0.82	0.71	0.55
	24	(610)	0.94	0.83	0.70			0.85	0.68	0.64	0.58		0.75	0.35			0.70	0.86	0.74	0.57
	26	(660)	0.98	0.86	0.72			0.90	0.70	0.65	0.59		0.84	0.39			0.78	0.89	0.77	0.60
28	(711)	1.00	0.89	0.73			0.95	0.71	0.66	0.60		0.94	0.44			0.88	0.92	0.80	0.62	
30	(762)		0.92	0.75			1.00	0.73	0.67	0.60		1.00	0.49			0.97	0.96	0.83	0.64	
36	(914)		1.00	0.80				0.77	0.71	0.62			0.64			1.00	1.00	0.91	0.70	
> 48	(1219)			0.90				0.87	0.77	0.66			0.98					1.00	0.81	

1 Linear interpolation not permitted.

2 Shaded area with reduced edge distance is permitted provided the rebar has no installation torque.

3 When combining multiple load adjustment factors (e.g. for a four-anchor pattern in a corner with thin concrete member) the design can become very conservative. To optimize the design, use Hilti PROFIS Anchor Design software or perform anchor calculation using design equations from ACI 318-14 Chapter 17.

 4 Spacing factor reduction in shear, f_{AV} , assumes an influence of a nearby edge. If no edge exists, then $f_{AV} = f_{AN}$.

 5 Concrete thickness reduction factor in shear, f_{HV} , assumes an influence of a nearby edge. If no edge exists, then $f_{HV} = 1.0$.

3.2.4 HIT-RE 500 V3 Epoxy Adhesive Anchoring System

Table 20 - Load adjustment factors for #9 rebar in uncracked concrete^{1,2,3}

#9 uncracked concrete	Spacing factor in tension			Edge distance factor in tension			Spacing factor in shear ⁴			Edge distance in shear						Concrete thickness factor in shear ⁵		
										⊥ Toward edge			∥ To and away from edge					
	f_{AN}	f_{RN}	f_{AV}	f_{RV}	f_{RV}	f_{RV}	f_{RV}	f_{RV}	f_{RV}	f_{RV}	f_{RV}	f_{RV}	f_{RV}	f_{RV}	f_{RV}	f_{HV}	f_{HV}	f_{HV}
Embedment h_{ef} in. (mm)	10-1/8 (257)	13-1/2 (343)	22-1/2 (572)	10-1/8 (257)	13-1/2 (343)	22-1/2 (572)	10-1/8 (257)	13-1/2 (343)	22-1/2 (572)	10-1/8 (257)	13-1/2 (343)	22-1/2 (572)	10-1/8 (257)	13-1/2 (343)	22-1/2 (572)	10-1/8 (257)	13-1/2 (343)	22-1/2 (572)
1-3/4 (44)	n/a	n/a	n/a	0.24	0.17	0.10	n/a	n/a	n/a	0.02	0.01	0.01	0.04	0.02	0.01	n/a	n/a	n/a
5-5/8 (143)	0.59	0.57	0.54	0.33	0.23	0.13	0.54	0.53	0.52	0.11	0.07	0.03	0.22	0.14	0.07	n/a	n/a	n/a
6 (152)	0.60	0.57	0.54	0.33	0.23	0.13	0.54	0.53	0.52	0.12	0.08	0.04	0.24	0.16	0.07	n/a	n/a	n/a
7 (178)	0.61	0.59	0.55	0.36	0.25	0.14	0.55	0.54	0.52	0.15	0.10	0.05	0.30	0.20	0.09	n/a	n/a	n/a
8 (203)	0.63	0.60	0.56	0.38	0.27	0.15	0.55	0.54	0.52	0.18	0.12	0.06	0.37	0.24	0.11	n/a	n/a	n/a
9 (229)	0.65	0.61	0.57	0.41	0.28	0.16	0.56	0.55	0.53	0.22	0.14	0.07	0.41	0.28	0.13	n/a	n/a	n/a
10 (254)	0.66	0.62	0.57	0.44	0.30	0.17	0.57	0.55	0.53	0.26	0.17	0.08	0.44	0.30	0.16	n/a	n/a	n/a
11 (279)	0.68	0.64	0.58	0.46	0.32	0.18	0.57	0.56	0.53	0.30	0.19	0.09	0.46	0.32	0.18	n/a	n/a	n/a
12 (305)	0.70	0.65	0.59	0.49	0.34	0.20	0.58	0.56	0.54	0.34	0.22	0.10	0.49	0.34	0.20	n/a	n/a	n/a
12-7/8 (327)	0.71	0.66	0.60	0.52	0.36	0.21	0.59	0.57	0.54	0.38	0.24	0.11	0.52	0.36	0.21	0.59	n/a	n/a
13 (330)	0.71	0.66	0.60	0.52	0.36	0.21	0.59	0.57	0.54	0.38	0.25	0.12	0.52	0.36	0.21	0.59	n/a	n/a
14 (356)	0.73	0.67	0.60	0.55	0.38	0.22	0.59	0.57	0.54	0.43	0.28	0.13	0.55	0.38	0.22	0.61	n/a	n/a
16 (406)	0.76	0.70	0.62	0.62	0.43	0.25	0.61	0.58	0.55	0.52	0.34	0.16	0.62	0.43	0.25	0.66	n/a	n/a
16-1/4 (413)	0.77	0.70	0.62	0.63	0.43	0.25	0.61	0.58	0.55	0.53	0.35	0.16	0.63	0.43	0.25	0.66	0.57	n/a
18 (457)	0.80	0.72	0.63	0.69	0.48	0.28	0.62	0.59	0.55	0.62	0.40	0.19	0.69	0.48	0.28	0.70	0.60	n/a
20 (508)	0.83	0.75	0.65	0.77	0.54	0.31	0.63	0.60	0.56	0.73	0.47	0.22	0.77	0.54	0.31	0.73	0.64	n/a
22 (559)	0.86	0.77	0.66	0.85	0.59	0.34	0.65	0.61	0.57	0.84	0.55	0.25	0.85	0.59	0.34	0.77	0.67	n/a
24 (610)	0.89	0.80	0.68	0.93	0.64	0.37	0.66	0.62	0.57	0.96	0.62	0.29	0.93	0.64	0.37	0.80	0.70	n/a
25-1/4 (641)	0.91	0.81	0.69	0.97	0.68	0.39	0.67	0.63	0.58	1.00	0.67	0.31	0.97	0.68	0.39	0.83	0.71	0.55
26 (660)	0.93	0.82	0.69	1.00	0.70	0.40	0.68	0.63	0.58		0.70	0.33	1.00	0.70	0.40	0.84	0.73	0.56
28 (711)	0.96	0.85	0.71		0.75	0.43	0.69	0.64	0.59		0.78	0.36		0.75	0.43	0.87	0.75	0.58
30 (762)	0.99	0.87	0.72		0.80	0.46	0.70	0.65	0.59		0.87	0.40		0.80	0.46	0.90	0.78	0.60
36 (914)	1.00	0.94	0.77		0.96	0.55	0.74	0.68	0.61		1.00	0.53		0.96	0.55	0.99	0.85	0.66
> 48 (1219)		1.00	0.86		1.00	0.74	0.82	0.74	0.65			0.82		1.00	0.74	1.00	0.99	0.76

Table 21 - Load adjustment factors for #9 rebar in cracked concrete^{1,2,3}

#9 cracked concrete	Spacing factor in tension			Edge distance factor in tension			Spacing factor in shear ⁴			Edge distance in shear						Concrete thickness factor in shear ⁵		
										⊥ Toward edge			∥ To and away from edge					
	f_{AN}	f_{RN}	f_{AV}	f_{RV}	f_{RV}	f_{RV}	f_{RV}	f_{RV}	f_{RV}	f_{RV}	f_{RV}	f_{RV}	f_{RV}	f_{RV}	f_{RV}	f_{RV}	f_{RV}	f_{RV}
Embedment h_{ef} in. (mm)	10-1/8 (257)	13-1/2 (343)	22-1/2 (572)	10-1/8 (257)	13-1/2 (343)	22-1/2 (572)	10-1/8 (257)	13-1/2 (343)	22-1/2 (572)	10-1/8 (257)	13-1/2 (343)	22-1/2 (572)	10-1/8 (257)	13-1/2 (343)	22-1/2 (572)	10-1/8 (257)	13-1/2 (343)	22-1/2 (572)
1-3/4 (44)	n/a	n/a	n/a	0.41	0.39	0.38	n/a	n/a	n/a	0.02	0.01	0.01	0.04	0.02	0.01	n/a	n/a	n/a
5-5/8 (143)	0.59	0.57	0.54	0.56	0.50	0.44	0.54	0.53	0.52	0.11	0.07	0.03	0.22	0.14	0.07	n/a	n/a	n/a
6 (152)	0.60	0.57	0.54	0.57	0.51	0.44	0.54	0.53	0.52	0.12	0.08	0.04	0.24	0.16	0.07	n/a	n/a	n/a
7 (178)	0.61	0.59	0.55	0.61	0.54	0.46	0.55	0.54	0.52	0.15	0.10	0.05	0.30	0.20	0.09	n/a	n/a	n/a
8 (203)	0.63	0.60	0.56	0.65	0.57	0.48	0.55	0.54	0.52	0.19	0.12	0.06	0.37	0.24	0.11	n/a	n/a	n/a
9 (229)	0.65	0.61	0.57	0.70	0.60	0.49	0.56	0.55	0.53	0.22	0.14	0.07	0.44	0.29	0.13	n/a	n/a	n/a
10 (254)	0.66	0.62	0.57	0.74	0.63	0.51	0.57	0.55	0.53	0.26	0.17	0.08	0.52	0.34	0.16	n/a	n/a	n/a
11 (279)	0.68	0.64	0.58	0.79	0.67	0.53	0.57	0.56	0.53	0.30	0.19	0.09	0.60	0.39	0.18	n/a	n/a	n/a
12 (305)	0.70	0.65	0.59	0.84	0.70	0.55	0.58	0.56	0.54	0.34	0.22	0.10	0.68	0.44	0.21	n/a	n/a	n/a
12-7/8 (327)	0.71	0.66	0.60	0.88	0.73	0.56	0.59	0.57	0.54	0.38	0.25	0.11	0.76	0.49	0.23	0.59	n/a	n/a
13 (330)	0.71	0.66	0.60	0.89	0.73	0.56	0.59	0.57	0.54	0.39	0.25	0.12	0.77	0.50	0.23	0.59	n/a	n/a
14 (356)	0.73	0.67	0.60	0.94	0.77	0.58	0.60	0.57	0.54	0.43	0.28	0.13	0.86	0.56	0.26	0.62	n/a	n/a
16 (406)	0.76	0.70	0.62	1.00	0.84	0.62	0.61	0.58	0.55	0.53	0.34	0.16	1.00	0.68	0.32	0.66	n/a	n/a
16-1/4 (413)	0.77	0.70	0.62	1.00	0.85	0.63	0.61	0.58	0.55	0.54	0.35	0.16	1.00	0.70	0.32	0.66	0.58	n/a
18 (457)	0.80	0.72	0.63	1.00	0.91	0.66	0.62	0.59	0.55	0.63	0.41	0.19	1.00	0.82	0.38	0.70	0.61	n/a
20 (508)	0.83	0.75	0.65	1.00	0.99	0.70	0.64	0.60	0.56	0.73	0.48	0.22	1.00	0.95	0.44	0.74	0.64	n/a
22 (559)	0.86	0.77	0.66	1.00	1.00	0.74	0.65	0.61	0.57	0.85	0.55	0.26	1.00	1.00	0.51	0.77	0.67	n/a
24 (610)	0.89	0.80	0.68	1.00	1.00	0.78	0.66	0.62	0.57	0.97	0.63	0.29	1.00	1.00	0.58	0.81	0.70	n/a
25-1/4 (641)	0.91	0.81	0.69	1.00	1.00	0.81	0.67	0.63	0.58	1.00	0.68	0.31	1.00	1.00	0.63	0.83	0.72	0.56
26 (660)	0.93	0.82	0.69	1.00	1.00	0.82	0.68	0.63	0.58	1.00	0.71	0.33	1.00	1.00	0.66	0.84	0.73	0.56
28 (711)	0.96	0.85	0.71	1.00	1.00	0.87	0.69	0.64	0.59	1.00	0.79	0.37	1.00	1.00	0.73	0.87	0.76	0.58
30 (762)	0.99	0.87	0.72	1.00	1.00	0.91	0.70	0.65	0.59	1.00	0.88	0.41	1.00	1.00	0.82	0.90	0.78	0.61
36 (914)	1.00	0.94	0.77	1.00	1.00	1.00	0.74	0.68	0.61	1.00	1.00	0.54	1.00	1.00	1.00	0.99	0.86	0.66
> 48 (1219)	1.00	1.00	0.86	1.00	1.00	1.00	0.83	0.74	0.65	1.00	1.00	0.82	1.00	1.00	1.00	1.00	0.99	0.77

1 Linear interpolation not permitted.

2 Shaded area with reduced edge distance is permitted provided the rebar has no installation torque.

3 When combining multiple load adjustment factors (e.g. for a four-anchor pattern in a corner with thin concrete member) the design can become very conservative. To optimize the design, use Hilti PROFIS Anchor Design software or perform anchor calculation using design equations from ACI 318-14 Chapter 17.

4 Spacing factor reduction in shear, f_{AV} , assumes an influence of a nearby edge. If no edge exists, then $f_{AV} = f_{AN}$.

5 Concrete thickness reduction factor in shear, f_{HV} , assumes an influence of a nearby edge. If no edge exists, then $f_{HV} = 1.0$.

HIT-RE 500 V3 Epoxy Adhesive Anchoring System 3.2.4

Table 22 - Load adjustment factors for #10 rebar in uncracked concrete^{1,2,3}

#10 uncracked concrete	Spacing factor in tension			Edge distance factor in tension			Spacing factor in shear ⁴			Edge distance in shear						Concrete thickness factor in shear ⁵			
										⊥ Toward edge			To and away from edge						
	Embedment h_{ef}	11-1/4	15	25	11-1/4	15	25	11-1/4	15	25	11-1/4	15	25	11-1/4	15	25	11-1/4	15	25
in. (mm)	(286)	(381)	(635)	(286)	(381)	(635)	(286)	(381)	(635)	(286)	(381)	(635)	(286)	(381)	(635)	(286)	(381)	(635)	
Spacing (s) / edge distance (c_a) / concrete thickness (h), - in. (mm)	1-3/4 (44)	n/a	n/a	n/a	0.24	0.17	0.09	n/a	n/a	n/a	0.02	0.01	0.00	0.03	0.02	0.01	n/a	n/a	n/a
	6-1/4 (159)	0.59	0.57	0.54	0.33	0.23	0.13	0.54	0.53	0.52	0.11	0.07	0.03	0.22	0.14	0.07	n/a	n/a	n/a
	7 (178)	0.60	0.58	0.55	0.35	0.24	0.14	0.54	0.53	0.52	0.13	0.08	0.04	0.26	0.17	0.08	n/a	n/a	n/a
	8 (203)	0.62	0.59	0.55	0.37	0.26	0.15	0.55	0.54	0.52	0.16	0.10	0.05	0.31	0.20	0.10	n/a	n/a	n/a
	9 (229)	0.63	0.60	0.56	0.39	0.27	0.15	0.55	0.54	0.52	0.19	0.12	0.06	0.38	0.24	0.11	n/a	n/a	n/a
	10 (254)	0.65	0.61	0.57	0.42	0.29	0.16	0.56	0.55	0.53	0.22	0.14	0.07	0.42	0.29	0.13	n/a	n/a	n/a
	11 (279)	0.66	0.62	0.57	0.44	0.31	0.17	0.57	0.55	0.53	0.25	0.16	0.08	0.44	0.31	0.15	n/a	n/a	n/a
	12 (305)	0.68	0.63	0.58	0.47	0.32	0.18	0.57	0.55	0.53	0.29	0.19	0.09	0.47	0.32	0.17	n/a	n/a	n/a
	13 (330)	0.69	0.64	0.59	0.49	0.34	0.19	0.58	0.56	0.54	0.33	0.21	0.10	0.49	0.34	0.19	n/a	n/a	n/a
	14 (356)	0.71	0.66	0.59	0.52	0.36	0.20	0.59	0.56	0.54	0.36	0.24	0.11	0.52	0.36	0.20	n/a	n/a	n/a
	14-1/4 (362)	0.71	0.66	0.60	0.52	0.36	0.21	0.59	0.56	0.54	0.37	0.24	0.11	0.52	0.36	0.21	0.59	n/a	n/a
	15 (381)	0.72	0.67	0.60	0.54	0.38	0.21	0.59	0.57	0.54	0.40	0.26	0.12	0.54	0.38	0.21	0.60	n/a	n/a
	16 (406)	0.74	0.68	0.61	0.57	0.40	0.22	0.60	0.57	0.54	0.45	0.29	0.13	0.57	0.40	0.22	0.62	n/a	n/a
	17 (432)	0.75	0.69	0.61	0.60	0.42	0.24	0.60	0.58	0.55	0.49	0.32	0.15	0.60	0.42	0.24	0.64	n/a	n/a
	18 (457)	0.77	0.70	0.62	0.64	0.44	0.25	0.61	0.58	0.55	0.53	0.35	0.16	0.64	0.44	0.25	0.66	0.57	n/a
	20 (508)	0.80	0.72	0.63	0.71	0.49	0.28	0.62	0.59	0.55	0.62	0.40	0.19	0.71	0.49	0.28	0.70	0.60	n/a
	22 (559)	0.83	0.74	0.65	0.78	0.54	0.31	0.63	0.60	0.56	0.72	0.47	0.22	0.78	0.54	0.31	0.73	0.63	n/a
	24 (610)	0.86	0.77	0.66	0.85	0.59	0.33	0.65	0.61	0.57	0.82	0.53	0.25	0.85	0.59	0.33	0.76	0.66	n/a
	26 (660)	0.89	0.79	0.67	0.92	0.64	0.36	0.66	0.62	0.57	0.92	0.60	0.28	0.92	0.64	0.36	0.79	0.69	n/a
	28 (711)	0.91	0.81	0.69	0.99	0.69	0.39	0.67	0.63	0.58	1.00	0.67	0.31	0.99	0.69	0.39	0.82	0.71	0.55
30 (762)	0.94	0.83	0.70	1.00	0.74	0.42	0.68	0.64	0.58		0.74	0.35	1.00	0.74	0.42	0.85	0.74	0.57	
36 (914)	1.00	0.90	0.74		0.88	0.50	0.72	0.66	0.60		0.98	0.45		0.88	0.50	0.94	0.81	0.63	
> 48 (1219)		1.00	0.82		1.00	0.67	0.79	0.72	0.63		1.00	0.70		1.00	0.67	1.00	0.94	0.72	

3.2.4

Table 23 - Load adjustment factors for #10 rebar in cracked concrete^{1,2,3}

#10 cracked concrete	Spacing factor in tension			Edge distance factor in tension			Spacing factor in shear ⁴			Edge distance in shear						Concrete thickness factor in shear ⁵			
										⊥ Toward edge			To and away from edge						
	Embedment h_{ef}	11-1/4	15	25	11-1/4	15	25	11-1/4	15	25	11-1/4	15	25	11-1/4	15	25	11-1/4	15	25
in. (mm)	(286)	(381)	(635)	(286)	(381)	(635)	(286)	(381)	(635)	(286)	(381)	(635)	(286)	(381)	(635)	(286)	(381)	(635)	
Spacing (s) / edge distance (c_a) / concrete thickness (h), - in. (mm)	1-3/4 (44)	n/a	n/a	n/a	0.40	0.39	0.37	n/a	n/a	n/a	0.02	0.01	0.00	0.03	0.02	0.01	n/a	n/a	n/a
	6-1/4 (159)	0.59	0.57	0.54	0.56	0.50	0.44	0.54	0.53	0.52	0.11	0.07	0.03	0.22	0.14	0.07	n/a	n/a	n/a
	7 (178)	0.60	0.58	0.55	0.58	0.52	0.45	0.54	0.53	0.52	0.13	0.08	0.04	0.26	0.17	0.08	n/a	n/a	n/a
	8 (203)	0.62	0.59	0.55	0.62	0.55	0.46	0.55	0.54	0.52	0.16	0.10	0.05	0.32	0.21	0.10	n/a	n/a	n/a
	9 (229)	0.63	0.60	0.56	0.66	0.57	0.48	0.55	0.54	0.52	0.19	0.12	0.06	0.38	0.25	0.11	n/a	n/a	n/a
	10 (254)	0.65	0.61	0.57	0.70	0.60	0.49	0.56	0.55	0.53	0.22	0.14	0.07	0.44	0.29	0.13	n/a	n/a	n/a
	11 (279)	0.66	0.62	0.57	0.74	0.63	0.51	0.57	0.55	0.53	0.26	0.17	0.08	0.51	0.33	0.15	n/a	n/a	n/a
	12 (305)	0.68	0.63	0.58	0.78	0.66	0.53	0.57	0.55	0.53	0.29	0.19	0.09	0.58	0.38	0.18	n/a	n/a	n/a
	13 (330)	0.69	0.64	0.59	0.82	0.69	0.54	0.58	0.56	0.54	0.33	0.21	0.10	0.66	0.43	0.20	n/a	n/a	n/a
	14 (356)	0.71	0.66	0.59	0.87	0.72	0.56	0.59	0.56	0.54	0.37	0.24	0.11	0.73	0.48	0.22	n/a	n/a	n/a
	14-1/4 (362)	0.71	0.66	0.60	0.88	0.73	0.56	0.59	0.57	0.54	0.38	0.25	0.11	0.75	0.49	0.23	0.59	n/a	n/a
	15 (381)	0.72	0.67	0.60	0.91	0.75	0.57	0.59	0.57	0.54	0.41	0.26	0.12	0.82	0.53	0.25	0.61	n/a	n/a
	16 (406)	0.74	0.68	0.61	0.96	0.78	0.59	0.60	0.57	0.54	0.45	0.29	0.14	0.90	0.58	0.27	0.63	n/a	n/a
	17 (432)	0.75	0.69	0.61	1.00	0.81	0.61	0.60	0.58	0.55	0.49	0.32	0.15	0.98	0.64	0.30	0.64	n/a	n/a
	18 (457)	0.77	0.70	0.62		0.85	0.62	0.61	0.58	0.55	0.54	0.35	0.16	1.00	0.70	0.32	0.66	0.57	n/a
	20 (508)	0.80	0.72	0.63		0.91	0.66	0.62	0.59	0.55	0.63	0.41	0.19		0.82	0.38	0.70	0.61	n/a
	22 (559)	0.83	0.74	0.65		0.98	0.69	0.63	0.60	0.56	0.72	0.47	0.22		0.94	0.44	0.73	0.63	n/a
	24 (610)	0.86	0.77	0.66		1.00	0.73	0.65	0.61	0.57	0.82	0.54	0.25		1.00	0.50	0.77	0.66	n/a
	26 (660)	0.89	0.79	0.67			0.77	0.66	0.62	0.57	0.93	0.60	0.28			0.56	0.80	0.69	n/a
	28 (711)	0.91	0.81	0.69			0.81	0.67	0.63	0.58	1.00	0.68	0.31			0.63	0.83	0.72	0.55
30 (762)	0.94	0.83	0.70			0.85	0.68	0.64	0.58		0.75	0.35			0.70	0.86	0.74	0.57	
36 (914)	1.00	0.90	0.74			0.97	0.72	0.66	0.60		0.98	0.46			0.91	0.94	0.81	0.63	
> 48 (1219)		1.00	0.82			1.00	0.79	0.72	0.63		1.00	0.70			1.00	1.00	0.94	0.73	

1 Linear interpolation not permitted.
 2 Shaded area with reduced edge distance is permitted provided the rebar has no installation torque.
 3 When combining multiple load adjustment factors (e.g. for a four-anchor pattern in a corner with thin concrete member) the design can become very conservative. To optimize the design, use Hilti PROFIS Anchor Design software or perform anchor calculation using design equations from ACI 318-14 Chapter 17.
 4 Spacing factor reduction in shear, f_{AV} , assumes an influence of a nearby edge. If no edge exists, then $f_{AV} = f_{AN}$.
 5 Concrete thickness reduction factor in shear, f_{HV} , assumes an influence of a nearby edge. If no edge exists, then $f_{HV} = 1.0$.

3.2.4 HIT-RE 500 V3 Epoxy Adhesive Anchoring System

3.2.4.3.4 HIT-RE 500 V3 adhesive with HAS/HIT-V threaded rod

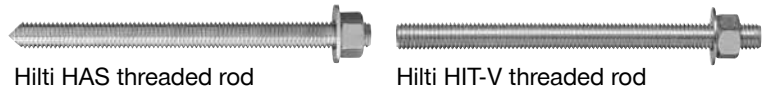

Figure 4 - Hilti HAS/HIT-V threaded rod installation conditions

Cracked or uncracked concrete	Permissible drilling methods	Permissible concrete conditions
<p>Cracked and uncracked concrete</p>	<p>Hammer drilling with carbide-tipped drill bit</p>	<p>Dry concrete</p> <p>Water-saturated concrete</p> <p>Water-filled holes</p> <p>Submerged (underwater)</p>
	<p>Hilti TE-CD or TE-YD hollow drill bit and VC 20/40 Vacuum</p> <p>Diamond core drill bit with Hilti TE-YRT roughening tool</p>	<p>Dry concrete</p> <p>Water-saturated concrete</p>
<p>Uncracked concrete</p>	<p>Diamond core drill bit</p>	<p>Dry concrete</p> <p>Water-saturated concrete</p>

Table 24 - Hilti HAS/HIT-V threaded rod installation specifications

Setting information	Symbol	Units	Nominal rod diameter, d						
			3/8	1/2	5/8	3/4	7/8	1	1-1/4
Nominal bit diameter	d_o	in.	7/16	9/16	3/4	7/8	1	1-1/8	1-3/8
Effective embedment	minimum	$h_{ef,min}$	in. 2-3/8 (60)	in. 2-3/4 (70)	in. 3-1/8 (79)	in. 3-1/2 (89)	in. 3-1/2 (89)	in. 4 (102)	in. 5 (127)
	maximum	$h_{ef,max}$	in. 7-1/2 (191)	in. 10 (254)	in. 12-1/2 (318)	in. 15 (381)	in. 17-1/2 (445)	in. 20 (508)	in. 25 (635)
Diameter of fixture hole	through-set		in. 1/2	in. 5/8	in. 13/16 ¹	in. 15/16 ¹	in. 1-1/8 ¹	in. 1-1/4 ¹	in. 1-1/2 ¹
	preset		in. 7/16	in. 9/16	in. 11/16	in. 13/16	in. 15/16	in. 1-1/8	in. 1-3/8
Installation torque	T_{inst}	ft-lb (Nm)	15 (20)	30 (40)	60 (80)	100 (136)	125 (169)	150 (203)	200 (271)
Minimum concrete thickness	h_{min}	in. (mm)	$h_{ef} + 1-1/4$ ($h_{ef} + 30$)			$h_{ef} + 2d_o$			
Minimum edge distance ²	c_{min}	in. (mm)	1-7/8 (48)	2-1/2 (64)	3-1/8 (79)	3-3/4 (95)	4-3/8 (111)	5 (127)	5-5/8 (143)
Minimum anchor spacing	s_{min}	in. (mm)	1-7/8 (48)	2-1/2 (64)	3-1/8 (79)	3-3/4 (95)	4-3/8 (111)	5 (127)	5-5/8 (143)

Figure 4 - Hilti HAS/HIT-V threaded rods

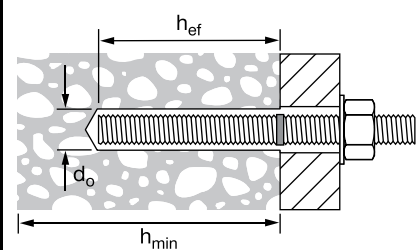

Figure 5 - Installation with (2) washers



1 Install using (2) washers. See Figure 5.

2 Edge distance of 1-3/4-inch (44mm) is permitted provided the installation torque is reduced to 0.30 T_{inst} for $5d < s < 16$ -in. and to 0.5 T_{inst} for $s > 16$ -in.

HIT-RE 500 V3 Epoxy Adhesive Anchoring System 3.2.4

Table 25 - Hilti HIT-RE 500 V3 adhesive design strength with concrete / bond failure for threaded rod in uncracked concrete^{1,2,3,4,5,6,7,8,9,11}

Nominal anchor diameter in.	Effective embedment in. (mm)	Tension — ΦN_t				Shear — ΦV_s			
		$f'_c = 2,500$ psi (17.2 MPa) lb (kN)	$f'_c = 3,000$ psi (20.7 MPa) lb (kN)	$f'_c = 4,000$ psi (27.6 MPa) lb (kN)	$f'_c = 6,000$ psi (41.4 MPa) lb (kN)	$f'_c = 2,500$ psi (17.2 MPa) lb (kN)	$f'_c = 3,000$ psi (20.7 MPa) lb (kN)	$f'_c = 4,000$ psi (27.6 MPa) lb (kN)	$f'_c = 6,000$ psi (41.4 MPa) lb (kN)
3/8	2-3/8 (60)	2,855 (12.7)	3,125 (13.9)	3,610 (16.1)	4,425 (19.7)	3,075 (13.7)	3,370 (15.0)	3,890 (17.3)	4,765 (21.2)
	3-3/8 (86)	4,835 (21.5)	5,300 (23.6)	6,115 (27.2)	7,490 (33.3)	10,415 (46.3)	11,410 (50.8)	13,175 (58.6)	16,135 (71.8)
	4-1/2 (114)	7,445 (33.1)	8,155 (36.3)	9,225 (41.0)	10,210 (45.4)	16,035 (71.3)	17,570 (78.2)	19,865 (88.4)	21,985 (97.8)
	7-1/2 (191)	13,670 (60.8)	14,305 (63.6)	15,375 (68.4)	17,015 (75.7)	29,440 (131.0)	30,815 (137.1)	33,110 (147.3)	36,645 (163.0)
1/2	2-3/4 (70)	3,555 (15.8)	3,895 (17.3)	4,500 (20.0)	5,510 (24.5)	7,660 (34.1)	8,395 (37.3)	9,690 (43.1)	11,870 (52.8)
	4-1/2 (114)	7,445 (33.1)	8,155 (36.3)	9,420 (41.9)	11,535 (51.3)	16,035 (71.3)	17,570 (78.2)	20,285 (90.2)	24,845 (110.5)
	6 (152)	11,465 (51.0)	12,560 (55.9)	14,500 (64.5)	17,535 (78.0)	24,690 (109.8)	27,045 (120.3)	31,230 (138.9)	37,775 (168.0)
	10 (254)	23,485 (104.5)	24,580 (109.3)	26,410 (117.5)	29,230 (130.0)	50,580 (225.0)	52,940 (235.5)	56,885 (253.0)	62,955 (280.0)
5/8 ¹⁰	3-1/8 (79)	4,310 (19.2)	4,720 (21.0)	5,450 (24.2)	6,675 (29.7)	9,280 (41.3)	10,165 (45.2)	11,740 (52.2)	14,380 (64.0)
	5-5/8 (143)	10,405 (46.3)	11,400 (50.7)	13,165 (58.6)	16,120 (71.7)	22,415 (99.7)	24,550 (109.2)	28,350 (126.1)	34,720 (154.4)
	7-1/2 (191)	16,020 (71.3)	17,550 (78.1)	20,265 (90.1)	24,820 (110.4)	34,505 (153.5)	37,800 (168.1)	43,650 (194.2)	53,455 (237.8)
	12-1/2 (318)	34,470 (153.3)	36,900 (164.1)	39,655 (176.4)	43,885 (195.2)	74,245 (330.3)	79,480 (353.5)	85,405 (379.9)	94,520 (420.4)
3/4 ¹⁰	3-1/2 (89)	5,105 (22.7)	5,595 (24.9)	6,460 (28.7)	7,910 (35.2)	11,000 (48.9)	12,050 (53.6)	13,915 (61.9)	17,040 (75.8)
	6-3/4 (171)	13,680 (60.9)	14,985 (66.7)	17,305 (77.0)	21,190 (94.3)	29,460 (131.0)	32,275 (143.6)	37,265 (165.8)	45,645 (203.0)
	9 (229)	21,060 (93.7)	23,070 (102.6)	26,640 (118.5)	32,625 (145.1)	45,360 (201.8)	49,690 (221.0)	57,375 (255.2)	70,270 (312.6)
	15 (381)	45,315 (201.6)	49,640 (220.8)	55,035 (244.8)	60,905 (270.9)	97,600 (434.1)	106,915 (475.6)	118,535 (527.3)	131,180 (583.5)
7/8 ¹⁰	3-1/2 (89)	5,105 (22.7)	5,595 (24.9)	6,460 (28.7)	7,910 (35.2)	11,000 (48.9)	12,050 (53.6)	13,915 (61.9)	17,040 (75.8)
	7-7/8 (200)	17,235 (76.7)	18,885 (84.0)	21,805 (97.0)	26,705 (118.8)	37,125 (165.1)	40,670 (180.9)	46,960 (208.9)	57,515 (255.8)
	10-1/2 (267)	26,540 (118.1)	29,070 (129.3)	33,570 (149.3)	41,115 (182.9)	57,160 (254.3)	62,615 (278.5)	72,300 (321.6)	88,550 (393.9)
	17-1/2 (445)	57,100 (254.0)	62,550 (278.2)	71,740 (319.1)	79,395 (353.2)	122,990 (547.1)	134,730 (599.3)	154,520 (687.3)	171,005 (760.7)
1 ¹⁰	4 (102)	6,240 (27.8)	6,835 (30.4)	7,895 (35.1)	9,665 (43.0)	13,440 (59.8)	14,725 (65.5)	17,000 (75.6)	20,820 (92.6)
	9 (229)	21,060 (93.7)	23,070 (102.6)	26,640 (118.5)	32,625 (145.1)	45,360 (201.8)	49,690 (221.0)	57,375 (255.2)	70,270 (312.6)
	12 (305)	32,425 (144.2)	35,520 (158.0)	41,015 (182.4)	50,230 (223.4)	69,835 (310.6)	76,500 (340.3)	88,335 (392.9)	108,190 (481.3)
	20 (508)	69,765 (310.3)	76,425 (340.0)	88,245 (392.5)	99,635 (443.2)	150,265 (668.4)	164,605 (732.2)	190,070 (845.5)	214,595 (954.6)
1-1/4 ¹⁰	5 (127)	8,720 (38.8)	9,555 (42.5)	11,030 (49.1)	13,510 (60.1)	18,785 (83.6)	20,575 (91.5)	23,760 (105.7)	29,100 (129.4)
	11-1/4 (286)	29,430 (130.9)	32,240 (143.4)	37,230 (165.6)	45,595 (202.8)	63,395 (282.0)	69,445 (308.9)	80,185 (356.7)	98,205 (436.8)
	15 (381)	45,315 (201.6)	49,640 (220.8)	57,320 (255.0)	70,200 (312.3)	97,600 (434.1)	106,915 (475.6)	123,455 (549.2)	151,200 (672.6)
	25 (635)	97,500 (433.7)	106,805 (475.1)	123,330 (548.6)	142,175 (632.4)	210,000 (934.1)	230,045 (1023.3)	265,630 (1181.6)	306,220 (1362.1)

3.2.4

- See Section 3.1.8 for explanation on development of load values.
- See Section 3.1.8.6 to convert design strength (factored resistance) value to ASD value.
- Linear interpolation between embedment depths and concrete compressive strengths is not permitted.
- Apply spacing, edge distance, and concrete thickness factors in Tables 30-41 as necessary to the above values. Compare to the steel values in Table 29. The lesser of the values is to be used for the design.
- Data is for temperature range A: Max. short term temperature = 130°F (55°C), max. long term temperature = 110°F (43°C). For temperature range B: Max. short term temperature = 176°F (80°C), max. long term temperature = 110°F (43°C) multiply above values by 0.69. Short term elevated concrete temperatures are those that occur over brief intervals, e.g., as a result of diurnal cycling. Long term concrete temperatures are roughly constant over significant periods of time.
- Tabular values are for dry or water saturated concrete conditions. For water-filled drilled holes multiply design strength by 0.51. For submerged (under water) applications multiply design strength by 0.45.
- Tabular values are for short term loads only. For sustained loads including overhead use, see Section 3.1.8.8.
- Tabular values are for normal-weight concrete only. For lightweight concrete multiply design strength (factored resistance) by λ_a as follows: For sand-lightweight, $\lambda_a = 0.51$. For all-lightweight, $\lambda_a = 0.45$.
- Tabular values are for holes drilled in concrete with carbide tipped hammer drill bit. For diamond core drilling, except as indicated in note 10, multiply above values by 0.55. Diamond core drilling is not permitted for water-filled or underwater (submerged) applications.
- Diamond core drilling with Hilti TE-YRT roughening tool is permitted for 5/8", 3/4", 7/8", 1", and 1 1/4" diameter anchors for dry and water-saturated concrete conditions. See Table 27.
- Tabular values are for static loads only. Seismic design is not permitted for uncracked concrete.

3.2.4 HIT-RE 500 V3 Epoxy Adhesive Anchoring System

Table 26 - Hilti HIT-RE 500 V3 adhesive design strength with concrete / bond failure for threaded rod in cracked concrete^{1,2,3,4,5,6,7,8,9,11}

Nominal anchor diameter in.	Effective embedment in. (mm)	Tension — ΦN_t				Shear — ΦV_s			
		$f'_c = 2,500$ psi (17.2 MPa) lb (kN)	$f'_c = 3,000$ psi (20.7 MPa) lb (kN)	$f'_c = 4,000$ psi (27.6 MPa) lb (kN)	$f'_c = 6,000$ psi (41.4 MPa) lb (kN)	$f'_c = 2,500$ psi (17.2 MPa) lb (kN)	$f'_c = 3,000$ psi (20.7 MPa) lb (kN)	$f'_c = 4,000$ psi (27.6 MPa) lb (kN)	$f'_c = 6,000$ psi (41.4 MPa) lb (kN)
3/8	2-3/8 (60)	2,020 (9.0)	2,215 (9.9)	2,500 (11.1)	2,655 (11.8)	2,180 (9.7)	2,385 (10.6)	2,690 (12.0)	2,860 (12.7)
	3-3/8 (86)	3,310 (14.7)	3,400 (15.1)	3,550 (15.8)	3,770 (16.8)	7,125 (31.7)	7,325 (32.6)	7,645 (34.0)	8,125 (36.1)
	4-1/2 (114)	4,410 (19.6)	4,535 (20.2)	4,735 (21.1)	5,030 (22.4)	9,500 (42.3)	9,765 (43.4)	10,195 (45.3)	10,835 (48.2)
	7-1/2 (191)	7,350 (32.7)	7,555 (33.6)	7,890 (35.1)	8,385 (37.3)	15,835 (70.4)	16,275 (72.4)	16,990 (75.6)	18,055 (80.3)
1/2	2-3/4 (70)	2,520 (11.2)	2,760 (12.3)	3,185 (14.2)	3,905 (17.4)	5,425 (24.1)	5,945 (26.4)	6,865 (30.5)	8,405 (37.4)
	4-1/2 (114)	5,275 (23.5)	5,780 (25.7)	6,260 (27.8)	6,655 (29.6)	11,360 (50.5)	12,445 (55.4)	13,485 (60.0)	14,330 (63.7)
	6 (152)	7,780 (34.6)	7,995 (35.6)	8,350 (37.1)	8,870 (39.5)	16,755 (74.5)	17,220 (76.6)	17,980 (80.0)	19,110 (85.0)
	10 (254)	12,965 (57.7)	13,325 (59.3)	13,915 (61.9)	14,785 (65.8)	27,930 (124.2)	28,705 (127.7)	29,970 (133.3)	31,850 (141.7)
5/8 ¹⁰	3-1/8 (79)	3,050 (13.6)	3,345 (14.9)	3,860 (17.2)	4,730 (21.0)	6,575 (29.2)	7,200 (32.0)	8,315 (37.0)	10,185 (45.3)
	5-5/8 (143)	7,370 (32.8)	8,075 (35.9)	9,325 (41.5)	10,315 (45.9)	15,875 (70.6)	17,390 (77.4)	20,080 (89.3)	22,215 (98.8)
	7-1/2 (191)	11,350 (50.5)	12,395 (55.1)	12,940 (57.6)	13,755 (61.2)	24,440 (108.7)	26,695 (118.7)	27,875 (124.0)	29,620 (131.8)
	12-1/2 (318)	20,100 (89.4)	20,660 (91.9)	21,570 (95.9)	22,920 (102.0)	43,295 (192.6)	44,495 (197.9)	46,460 (206.7)	49,370 (219.6)
3/4 ¹⁰	3-1/2 (89)	3,620 (16.1)	3,965 (17.6)	4,575 (20.4)	5,605 (24.9)	7,790 (34.7)	8,535 (38.0)	9,855 (43.8)	12,070 (53.7)
	6-3/4 (171)	9,690 (43.1)	10,615 (47.2)	12,255 (54.5)	14,735 (65.5)	20,870 (92.8)	22,860 (101.7)	26,395 (117.4)	31,740 (141.2)
	9 (229)	14,920 (66.4)	16,340 (72.7)	18,490 (82.2)	19,650 (87.4)	32,130 (142.9)	35,195 (156.6)	39,820 (177.1)	42,320 (188.2)
	15 (381)	28,715 (127.7)	29,510 (131.3)	30,815 (137.1)	32,745 (145.7)	61,850 (275.1)	63,565 (282.7)	66,370 (295.2)	70,530 (313.7)
7/8 ¹⁰	3-1/2 (89)	3,620 (16.1)	3,965 (17.6)	4,575 (20.4)	5,605 (24.9)	7,790 (34.7)	8,535 (38.0)	9,855 (43.8)	12,070 (53.7)
	7-7/8 (200)	12,210 (54.3)	13,375 (59.5)	15,445 (68.7)	18,915 (84.1)	26,300 (117.0)	28,810 (128.2)	33,265 (148.0)	40,740 (181.2)
	10-1/2 (267)	18,800 (83.6)	20,590 (91.6)	23,780 (105.8)	26,530 (118.0)	40,490 (180.1)	44,355 (197.3)	51,215 (227.8)	57,140 (254.2)
	17-1/2 (445)	38,775 (172.5)	39,850 (177.3)	41,605 (185.1)	44,215 (196.7)	83,510 (371.5)	85,825 (381.8)	89,610 (398.6)	95,230 (423.6)
1 ¹⁰	4 (102)	4,420 (19.7)	4,840 (21.5)	5,590 (24.9)	6,845 (30.4)	9,520 (42.3)	10,430 (46.4)	12,040 (53.6)	14,750 (65.6)
	9 (229)	14,920 (66.4)	16,340 (72.7)	18,870 (83.9)	23,110 (102.8)	32,130 (142.9)	35,195 (156.6)	40,640 (180.8)	49,775 (221.4)
	12 (305)	22,965 (102.2)	25,160 (111.9)	29,050 (129.2)	34,650 (154.1)	49,465 (220.0)	54,190 (241.0)	62,570 (278.3)	74,630 (332.0)
	20 (508)	49,415 (219.8)	52,045 (231.5)	54,340 (241.7)	57,750 (256.9)	106,435 (473.4)	112,100 (498.6)	117,045 (520.6)	124,385 (553.3)
1-1/4 ¹⁰	5 (127)	6,175 (27.5)	6,765 (30.1)	7,815 (34.8)	9,570 (42.6)	13,305 (59.2)	14,575 (64.8)	16,830 (74.9)	20,610 (91.7)
	11-1/4 (286)	20,850 (92.7)	22,840 (101.6)	26,370 (117.3)	32,295 (143.7)	44,905 (199.7)	49,190 (218.2)	56,800 (252.7)	69,565 (309.4)
	15 (381)	32,095 (142.8)	35,160 (156.4)	40,600 (180.6)	49,725 (221.2)	69,135 (307.5)	75,730 (336.9)	87,445 (389.0)	107,100 (476.4)
	25 (635)	69,060 (307.2)	75,655 (336.5)	80,800 (359.4)	85,865 (381.9)	148,750 (661.7)	162,945 (724.8)	174,030 (774.1)	184,945 (822.7)

1 See Section 3.1.8 for explanation on development of load values.
 2 See Section 3.1.8.6 to convert design strength value to ASD value.
 3 Linear interpolation between embedment depths and concrete compressive strengths is not permitted.
 4 Apply spacing, edge distance, and concrete thickness factors in tables 30-41 as necessary to the above values. Compare to the steel values in table 29. The lesser of the values is to be used for the design.
 5 Data is for temperature range A: Max. short term temperature = 130°F (55°C), max. long term temperature = 110°F (43°C).
 For temperature range B: Max. short term temperature = 176°F (80°C), max. long term temperature = 110°F (43°C) multiply above values by 0.69.
 Short term elevated concrete temperatures are those that occur over brief intervals, e.g., as a result of diurnal cycling. Long term concrete temperatures are roughly constant over significant periods of time.
 6 Tabular values are for dry or water saturated concrete conditions.
 For water-filled drilled holes multiply design strength by 0.51.
 For submerged (under water) applications multiply design strength by 0.44.
 7 Tabular values are for short term loads only. For sustained loads including overhead use, see Section 3.1.8.8.
 8 Tabular values are for normal-weight concrete only. For lightweight concrete multiply design strength by λ_a as follows:
 For sand-lightweight, $\lambda_a = 0.51$. For all-lightweight, $\lambda_a = 0.45$.
 9 Tabular values are for holes drilled in concrete with carbide tipped hammer drill bit. Diamond core drilling is not permitted in cracked concrete conditions except as indicated in note 10.
 10 Diamond core drilling with Hilti TE-YRT roughening tool is permitted for 5/8" 3/4", 7/8", 1", and 1 1/4" diameter anchors for dry and water-saturated concrete conditions. See Table 28
 11 Tabular values are for static loads only. For seismic loads, multiply cracked concrete tabular values in tension and shear by α_{seis} indicated below.
 See section 3.1.8.7 for additional information on seismic applications.
 3/8-in. diameter - $\alpha_{seis} = 0.69$
 1/2-in. diameter - $\alpha_{seis} = 0.70$
 5/8-in. diameter - $\alpha_{seis} = 0.71$
 3/4-in. diameter and larger - $\alpha_{seis} = 0.75$

HIT-RE 500 V3 Epoxy Adhesive Anchoring System 3.2.4

Table 27 - Hilti HIT-RE 500 V3 for Core Drilled Holes with TE-YRT Roughening Tool adhesive design strength with concrete / bond failure for threaded rod in uncracked concrete^{1,2,3,4,5,6,7,8,9}

Nominal anchor diameter in.	Effective embedment in. (mm)	Tension — ΦN_t				Shear — ΦV_n			
		$f'_c = 2,500$ psi (17.2 MPa) lb (kN)	$f'_c = 3,000$ psi (20.7 MPa) lb (kN)	$f'_c = 4,000$ psi (27.6 MPa) lb (kN)	$f'_c = 6,000$ psi (41.4 MPa) lb (kN)	$f'_c = 2,500$ psi (17.2 MPa) lb (kN)	$f'_c = 3,000$ psi (20.7 MPa) lb (kN)	$f'_c = 4,000$ psi (27.6 MPa) lb (kN)	$f'_c = 6,000$ psi (41.4 MPa) lb (kN)
5/8	3-1/8 (79)	4,310 (19.2)	4,720 (21.0)	5,450 (24.2)	6,675 (29.7)	9,280 (41.3)	10,165 (45.2)	11,740 (52.2)	14,380 (64.0)
	5-5/8 (143)	10,405 (46.3)	11,400 (50.7)	13,165 (58.6)	15,865 (70.6)	22,415 (99.7)	24,550 (109.2)	28,350 (126.1)	34,170 (152.0)
	7-1/2 (191)	16,020 (71.3)	17,550 (78.1)	20,265 (90.1)	21,155 (94.1)	34,505 (153.5)	37,800 (168.1)	43,650 (194.2)	45,565 (202.7)
	12-1/2 (318)	34,470 (153.3)	35,255 (156.8)	35,255 (156.8)	35,255 (156.8)	74,245 (330.3)	75,940 (337.8)	75,940 (337.8)	75,940 (337.8)
3/4	3-1/2 (89)	5,105 (22.7)	5,595 (24.9)	6,460 (28.7)	7,910 (35.2)	11,000 (48.9)	12,050 (53.6)	13,915 (61.9)	17,040 (75.8)
	6-3/4 (171)	13,680 (60.9)	14,985 (66.7)	17,305 (77.0)	21,190 (94.3)	29,460 (131.0)	32,275 (143.6)	37,265 (165.8)	45,645 (203.0)
	9 (229)	21,060 (93.7)	23,070 (102.6)	26,640 (118.5)	29,360 (130.6)	45,360 (201.8)	49,690 (221.0)	57,375 (255.2)	63,235 (281.3)
	11-1/4 (286)	29,430 (130.9)	32,240 (143.4)	36,700 (163.2)	36,700 (163.2)	63,395 (282.0)	69,445 (308.9)	79,045 (351.6)	79,045 (351.6)
7/8	3-1/2 (89)	5,105 (22.7)	5,595 (24.9)	6,460 (28.7)	7,910 (35.2)	11,000 (48.9)	12,050 (53.6)	13,915 (61.9)	17,040 (75.8)
	7-7/8 (200)	17,235 (76.7)	18,885 (84.0)	21,805 (97.0)	26,705 (118.8)	37,125 (165.1)	40,670 (180.9)	46,960 (208.9)	57,515 (255.8)
	10-1/2 (267)	26,540 (118.1)	29,070 (129.3)	33,570 (149.3)	38,275 (170.3)	57,160 (254.3)	62,615 (278.5)	72,300 (321.6)	82,435 (366.7)
	17-1/2 (445)	57,100 (254.0)	62,550 (278.2)	63,790 (283.8)	63,790 (283.8)	122,990 (547.1)	134,730 (599.3)	137,390 (611.1)	137,390 (611.1)
1	4 (102)	6,240 (27.8)	6,835 (30.4)	7,895 (35.1)	9,665 (43.0)	13,440 (59.8)	14,725 (65.5)	17,000 (75.6)	20,820 (92.6)
	9 (229)	21,060 (93.7)	23,070 (102.6)	26,640 (118.5)	32,625 (145.1)	45,360 (201.8)	49,690 (221.0)	57,375 (255.2)	70,270 (312.6)
	12 (305)	32,425 (144.2)	35,520 (158.0)	41,015 (182.4)	48,030 (213.6)	69,835 (310.6)	76,500 (340.3)	88,335 (392.9)	103,445 (460.1)
	20 (508)	69,765 (310.3)	76,425 (340.0)	80,050 (356.1)	80,050 (356.1)	150,265 (668.4)	164,605 (732.2)	172,410 (766.9)	172,410 (766.9)
1-1/4	5 (127)	8,720 (38.8)	9,555 (42.5)	11,030 (49.1)	13,510 (60.1)	18,785 (83.6)	20,575 (91.5)	23,760 (105.7)	29,100 (129.4)
	11-1/4 (286)	29,430 (130.9)	32,240 (143.4)	37,230 (165.6)	45,595 (202.8)	63,395 (282.0)	69,445 (308.9)	80,185 (356.7)	98,205 (436.8)
	15 (381)	45,315 (201.6)	49,640 (220.8)	57,320 (255.0)	68,535 (304.9)	97,600 (434.1)	106,915 (475.6)	123,455 (549.2)	147,615 (656.6)
	25 (635)	97,500 (433.7)	106,805 (475.1)	114,225 (508.1)	114,225 (508.1)	210,000 (934.1)	230,045 (1023.3)	246,025 (1094.4)	246,025 (1094.4)

3.2.4

- 1 See Section 3.1.8 for explanation on development of load values.
- 2 See Section 3.1.8.6 to convert design strength value to ASD value.
- 3 Linear interpolation between embedment depths and concrete compressive strengths is not permitted.
- 4 Apply spacing, edge distance, and concrete thickness factors in tables 30-41 as necessary to the above values. Compare to the steel values in table 29. The lesser of the values is to be used for the design.
- 5 Data is for temperature range A: Max. short term temperature = 130°F (55°C), max. long term temperature = 110°F (43°C).
For temperature range B: Max. short term temperature = 176°F (80°C), max. long term temperature = 110°F (43°C) multiply above values by 0.69.
Short term elevated concrete temperatures are those that occur over brief intervals, e.g., as a result of diurnal cycling. Long term concrete temperatures are roughly constant over significant periods of time.
- 6 Tabular values are for dry or water saturated concrete conditions. Water-filled and submerged (under water) applications are not permitted for this hole preparation method.
- 7 Tabular values are for short term loads only. For sustained loads including overhead use, see Section 3.1.8.8.
- 8 Tabular values are for normal-weight concrete only. For lightweight concrete multiply design strength by λ_s as follows:
For sand-lightweight, $\lambda_s = 0.51$. For all-lightweight, $\lambda_s = 0.45$.
- 9 Tabular values are for static loads only. Seismic design is not permitted for uncracked concrete. For seismic loads, multiply cracked concrete tabular values in tension and shear by $\alpha_{seis} = 0.75$. See section 3.1.8.7 for additional information on seismic applications.

3.2.4 HIT-RE 500 V3 Epoxy Adhesive Anchoring System

Table 28 - Hilti HIT-RE 500 V3 for Core Drilled Holes with TE-YRT Roughening Tool adhesive design strength with concrete / bond failure for threaded rod in cracked concrete^{1,2,3,4,5,6,7,8,9}

Nominal anchor diameter in.	Effective embedment in. (mm)	Tension — ΦN_t				Shear — ΦV_n			
		$f'_c = 2,500$ psi (17.2 MPa) lb (kN)	$f'_c = 3,000$ psi (20.7 MPa) lb (kN)	$f'_c = 4,000$ psi (27.6 MPa) lb (kN)	$f'_c = 6,000$ psi (41.4 MPa) lb (kN)	$f'_c = 2,500$ psi (17.2 MPa) lb (kN)	$f'_c = 3,000$ psi (20.7 MPa) lb (kN)	$f'_c = 4,000$ psi (27.6 MPa) lb (kN)	$f'_c = 6,000$ psi (41.4 MPa) lb (kN)
5/8	3-1/8 (79)	3,050 (13.6)	3,345 (14.9)	3,510 (15.6)	3,510 (15.6)	6,575 (29.2)	7,200 (32.0)	7,560 (33.6)	7,560 (33.6)
	5-5/8 (143)	6,320 (28.1)	6,320 (28.1)	6,320 (28.1)	6,320 (28.1)	13,605 (60.5)	13,605 (60.5)	13,605 (60.5)	13,605 (60.5)
	7-1/2 (191)	8,425 (37.5)	8,425 (37.5)	8,425 (37.5)	8,425 (37.5)	18,145 (80.7)	18,145 (80.7)	18,145 (80.7)	18,145 (80.7)
	12-1/2 (318)	14,040 (62.5)	14,040 (62.5)	14,040 (62.5)	14,040 (62.5)	30,240 (134.5)	30,240 (134.5)	30,240 (134.5)	30,240 (134.5)
3/4	3-1/2 (89)	3,620 (16.1)	3,965 (17.6)	4,575 (20.4)	4,690 (20.9)	7,790 (34.7)	8,535 (38.0)	9,855 (43.8)	10,100 (44.9)
	6-3/4 (171)	9,045 (40.2)	9,045 (40.2)	9,045 (40.2)	9,045 (40.2)	19,485 (86.7)	19,485 (86.7)	19,485 (86.7)	19,485 (86.7)
	9 (229)	12,060 (53.6)	12,060 (53.6)	12,060 (53.6)	12,060 (53.6)	25,975 (115.5)	25,975 (115.5)	25,975 (115.5)	25,975 (115.5)
	11-1/4 (286)	15,075 (67.1)	15,075 (67.1)	15,075 (67.1)	15,075 (67.1)	32,470 (144.4)	32,470 (144.4)	32,470 (144.4)	32,470 (144.4)
7/8	3-1/2 (89)	3,620 (16.1)	3,965 (17.6)	4,575 (20.4)	5,440 (24.2)	7,790 (34.7)	8,535 (38.0)	9,855 (43.8)	11,720 (52.1)
	7-7/8 (200)	12,210 (54.3)	12,240 (54.4)	12,240 (54.4)	12,240 (54.4)	26,300 (117.0)	26,365 (117.3)	26,365 (117.3)	26,365 (117.3)
	10-1/2 (267)	16,320 (72.6)	16,320 (72.6)	16,320 (72.6)	16,320 (72.6)	35,155 (156.4)	35,155 (156.4)	35,155 (156.4)	35,155 (156.4)
	17-1/2 (445)	27,205 (121.0)	27,205 (121.0)	27,205 (121.0)	27,205 (121.0)	58,595 (260.6)	58,595 (260.6)	58,595 (260.6)	58,595 (260.6)
1	4 (102)	4,420 (19.7)	4,840 (21.5)	5,590 (24.9)	6,845 (30.4)	9,520 (42.3)	10,430 (46.4)	12,040 (53.6)	14,750 (65.6)
	9 (229)	14,920 (66.4)	15,990 (71.1)	15,990 (71.1)	15,990 (71.1)	32,130 (142.9)	34,440 (153.2)	34,440 (153.2)	34,440 (153.2)
	12 (305)	21,320 (94.8)	21,320 (94.8)	21,320 (94.8)	21,320 (94.8)	45,920 (204.3)	45,920 (204.3)	45,920 (204.3)	45,920 (204.3)
	20 (508)	35,530 (158.0)	35,530 (158.0)	35,530 (158.0)	35,530 (158.0)	76,530 (340.4)	76,530 (340.4)	76,530 (340.4)	76,530 (340.4)
1-1/4	5 (127)	6,175 (27.5)	6,765 (30.1)	7,815 (34.8)	9,570 (42.6)	13,305 (59.2)	14,575 (64.8)	16,830 (74.9)	20,610 (91.7)
	11-1/4 (286)	20,850 (92.7)	22,840 (101.6)	23,690 (105.4)	23,690 (105.4)	44,905 (199.7)	49,190 (218.8)	51,025 (227.0)	51,025 (227.0)
	15 (381)	31,590 (140.5)	31,590 (140.5)	31,590 (140.5)	31,590 (140.5)	68,035 (302.6)	68,035 (302.6)	68,035 (302.6)	68,035 (302.6)
	25 (635)	52,645 (234.2)	52,645 (234.2)	52,645 (234.2)	52,645 (234.2)	113,390 (504.4)	113,390 (504.4)	113,390 (504.4)	113,390 (504.4)

- 1 See Section 3.1.8 for explanation on development of load values.
- 2 See Section 3.1.8.6 to convert design strength value to ASD value.
- 3 Linear interpolation between embedment depths and concrete compressive strengths is not permitted.
- 4 Apply spacing, edge distance, and concrete thickness factors in tables 30-41 as necessary to the above values. Compare to the steel values in table 29. The lesser of the values is to be used for the design.
- 5 Data is for temperature range A: Max. short term temperature = 130°F (55°C), max. long term temperature = 110°F (43°C).
For temperature range B: Max. short term temperature = 176°F (80°C), max. long term temperature = 110°F (43°C) multiply above values by 0.69.
Short term elevated concrete temperatures are those that occur over brief intervals, e.g., as a result of diurnal cycling. Long term concrete temperatures are roughly constant over significant periods of time.
- 6 Tabular values are for dry or water saturated concrete conditions. Water-filled and submerged (under water) applications are not permitted for this hole preparation method.
- 7 Tabular values are for short term loads only. For sustained loads including overhead use, see Section 3.1.8.8.
- 8 Tabular values are for normal-weight concrete only. For lightweight concrete multiply design strength by λ_s as follows:
For sand-lightweight, $\lambda_s = 0.51$. For all-lightweight, $\lambda_s = 0.45$.
- 9 Tabular values are for static loads only. Seismic design is not permitted for uncracked concrete. For seismic loads, multiply cracked concrete tabular values in tension and shear by $\alpha_{seis} = 0.75$. See section 3.1.8.7 for additional information on seismic applications.

HIT-RE 500 V3 Epoxy Adhesive Anchoring System 3.2.4

Table 29 - Steel design strength for Hilti HIT-V and HAS threaded rods¹

Nominal anchor diameter in.	HIT-V ASTM A307 Grade A ²			HAS-E ISO 898 Class 5.8 ²			HAS-E-B ASTM A193 B7 ³			HAS-R stainless steel ASTM F593 - AISI 304/316 SS ²		
	Tensile ⁴ ϕN_{sa} lb (kN)	Shear ⁵ ϕV_{sa} lb (kN)	Seismic Shear ⁶ $\phi V_{sa,eq}$ lb (kN)	Tensile ⁴ ϕN_{sa} lb (kN)	Shear ⁵ ϕV_{sa} lb (kN)	Seismic Shear ⁶ $\phi V_{sa,eq}$ lb (kN)	Tensile ⁴ ϕN_{sa} lb (kN)	Shear ⁵ ϕV_{sa} lb (kN)	Seismic Shear ⁶ $\phi V_{sa,eq}$ lb (kN)	Tensile ⁴ ϕN_{sa} lb (kN)	Shear ⁵ ϕV_{sa} lb (kN)	Seismic Shear ⁶ $\phi V_{sa,eq}$ lb (kN)
3/8	3,025 (13.5)	1,675 (7.5)	1,175 (5.2)	3,655 (16.3)	2,020 (9.0)	2,020 (9.0)	7,265 (32.3)	3,775 (16.8)	3,775 (16.8)	5,040 (22.4)	2,790 (12.4)	2,230 (9.9)
1/2	5,535 (24.6)	3,065 (13.6)	2,145 (9.5)	6,690 (29.8)	3,705 (16.5)	3,705 (16.5)	13,300 (59.2)	6,915 (30.8)	6,915 (30.8)	9,225 (41.0)	5,110 (22.7)	4,090 (18.2)
5/8	8,815 (39.2)	4,880 (21.7)	3,415 (15.2)	10,650 (47.4)	5,900 (26.2)	5,900 (26.2)	21,190 (94.3)	11,020 (49.0)	11,020 (49.0)	14,690 (65.3)	8,135 (36.2)	6,510 (29.0)
3/4	13,045 (58.0)	7,225 (32.1)	5,060 (22.5)	15,765 (70.1)	8,730 (38.8)	8,730 (38.8)	31,360 (139.5)	16,305 (72.5)	16,305 (72.5)	18,480 (82.2)	10,235 (45.5)	8,190 (36.4)
7/8	-	-	-	21,755 (96.8)	12,050 (53.6)	12,050 (53.6)	43,285 (192.5)	22,505 (100.1)	22,505 (100.1)	25,510 (113.5)	14,125 (62.8)	11,300 (50.3)
1	23,620 (105.1)	13,085 (58.2)	9,160 (40.7)	28,540 (127.0)	15,805 (70.3)	15,805 (70.3)	56,785 (252.6)	29,525 (131.3)	29,525 (131.3)	33,465 (148.9)	18,535 (82.4)	14,830 (66.0)
1-1/4	-	-	-	45,670 (203.1)	25,295 (112.5)	25,295 (112.5)	90,850 (404.1)	47,240 (210.1)	47,240 (210.1)	53,540 (238.2)	29,655 (131.9)	23,725 (105.5)

1 See Section 3.1.8.6 to convert design strength value to ASD value.

2 HIT-V, HAS-E, and HAS-R threaded rods are considered brittle steel elements. HIT-V does not comply with % elongation requirements of ASTM A307 Grade A steel. HAS-E does not comply with % elongation requirements of ISO 898-1.

3 HAS-E-B7 rods are considered ductile steel elements.

4 Tensile = $\phi A_{se,N} f_{uta}$ as noted in ACI 318 Chapter 17.

5 Shear = $\phi 0.60 A_{se,V} f_{uta}$ as noted in ACI 318 Chapter 17.

6 Seismic Shear = $\alpha_{V,seis} \phi V_{sa}$: Reduction for seismic shear only. See section 3.1.8.7 for additional information on seismic applications.

3.2.4 HIT-RE 500 V3 Epoxy Adhesive Anchoring System

Table 30 - Load adjustment factors for 3/8-in. diameter threaded rods in uncracked concrete^{1,2,3}

3/8-in. uncracked concrete	Spacing factor in tension f_{AN}				Edge distance factor in tension f_{RN}				Spacing factor in shear ⁴ f_{AV}				Edge distance in shear								Concrete thickness factor in shear ⁵ f_{HV}				
													⊥ Toward edge f_{RV}				To and away from edge f_{RV}								
Embedment in. h_{ef} (mm)	2-3/8 (60)	3-3/8 (86)	4-1/2 (114)	7-1/2 (191)	2-3/8 (60)	3-3/8 (86)	4-1/2 (114)	7-1/2 (191)	2-3/8 (60)	3-3/8 (86)	4-1/2 (114)	7-1/2 (191)	2-3/8 (60)	3-3/8 (86)	4-1/2 (114)	7-1/2 (191)	2-3/8 (60)	3-3/8 (86)	4-1/2 (114)	7-1/2 (191)	2-3/8 (60)	3-3/8 (86)	4-1/2 (114)	7-1/2 (191)	
1-3/4 (44)	n/a	n/a	n/a	n/a	0.35	0.26	0.21	0.12	n/a	n/a	n/a	n/a	0.23	0.07	0.05	0.03	0.35	0.14	0.09	0.05	0.05	n/a	n/a	n/a	n/a
1-7/8 (48)	0.58	0.58	0.57	0.54	0.36	0.27	0.22	0.13	0.57	0.53	0.52	0.52	0.25	0.08	0.05	0.03	0.36	0.16	0.10	0.06	n/a	n/a	n/a	n/a	
2 (51)	0.58	0.58	0.57	0.54	0.37	0.28	0.23	0.13	0.57	0.53	0.52	0.52	0.28	0.09	0.06	0.03	0.37	0.17	0.11	0.06	n/a	n/a	n/a	n/a	
3 (76)	0.62	0.62	0.61	0.57	0.48	0.34	0.27	0.16	0.61	0.55	0.54	0.52	0.51	0.16	0.10	0.06	0.48	0.32	0.21	0.11	n/a	n/a	n/a	n/a	
3-5/8 (92)	0.65	0.65	0.63	0.58	0.56	0.38	0.30	0.17	0.63	0.56	0.54	0.53	0.68	0.21	0.14	0.07	0.56	0.38	0.27	0.15	0.72	n/a	n/a	n/a	
4 (102)	0.66	0.66	0.65	0.59	0.62	0.41	0.31	0.18	0.64	0.57	0.55	0.53	0.79	0.24	0.16	0.09	0.62	0.41	0.31	0.17	0.75	n/a	n/a	n/a	
4-5/8 (117)	0.69	0.69	0.67	0.60	0.71	0.45	0.35	0.20	0.66	0.58	0.56	0.54	0.98	0.30	0.20	0.11	0.71	0.45	0.35	0.20	0.81	0.55	n/a	n/a	
5 (127)	0.70	0.70	0.69	0.61	0.77	0.48	0.36	0.21	0.68	0.58	0.56	0.54	1.00	0.34	0.22	0.12	0.77	0.48	0.36	0.21	0.84	0.57	n/a	n/a	
5-3/4 (146)	0.73	0.73	0.71	0.63	0.89	0.55	0.40	0.23	0.70	0.59	0.57	0.55		0.42	0.27	0.15	0.89	0.55	0.40	0.23	0.91	0.61	0.53	n/a	
6 (152)	0.74	0.74	0.72	0.63	0.92	0.58	0.42	0.24	0.71	0.60	0.57	0.55		0.45	0.29	0.16	0.92	0.58	0.42	0.24	0.92	0.63	0.54	n/a	
7 (178)	0.78	0.78	0.76	0.66	1.00	0.67	0.48	0.28	0.75	0.61	0.59	0.56		0.57	0.37	0.20	1.00	0.67	0.48	0.28	1.00	0.68	0.58	n/a	
8 (203)	0.82	0.82	0.80	0.68		0.77	0.55	0.32	0.79	0.63	0.60	0.57		0.69	0.45	0.24		0.77	0.55	0.32		0.72	0.63	n/a	
8-3/4 (222)	0.86	0.86	0.82	0.69		0.84	0.61	0.35	0.81	0.64	0.61	0.57		0.79	0.51	0.28		0.84	0.61	0.35		0.76	0.65	0.53	
9 (229)	0.87	0.87	0.83	0.70		0.86	0.62	0.36	0.82	0.65	0.61	0.57		0.83	0.54	0.29		0.86	0.62	0.36		0.77	0.66	0.54	
10 (254)	0.91	0.91	0.87	0.72		0.96	0.69	0.40	0.86	0.66	0.62	0.58		0.97	0.63	0.34		0.96	0.69	0.40		0.81	0.70	0.57	
11 (279)	0.95	0.95	0.91	0.74		1.00	0.76	0.44	0.89	0.68	0.63	0.59		1.00	0.72	0.39		1.00	0.76	0.44		0.85	0.73	0.60	
12 (305)	0.99	0.99	0.94	0.77			0.83	0.48	0.93	0.70	0.65	0.60			0.83	0.45			0.83	0.48		0.88	0.77	0.63	
14 (356)	1.00	1.00	1.00	0.81			0.97	0.56	1.00	0.73	0.67	0.61			1.00	0.57			0.97	0.56		0.96	0.83	0.68	
16 (406)				0.86			1.00	0.64		0.76	0.70	0.63				0.69			1.00	0.64		1.00	0.88	0.72	
18 (457)				0.90				0.72		0.79	0.72	0.65				0.83				0.72			0.94	0.77	
24 (610)				1.00				0.96		0.89	0.79	0.70				1.00				0.96			1.00	0.88	
30 (762)								1.00		0.99	0.87	0.74								1.00				0.99	
36 (914)										1.00	0.94	0.79												1.00	
> 48 (1219)											1.00	0.89													

Table 31 - Load adjustment factors for 3/8-in. diameter threaded rods in cracked concrete^{1,2,3}

3/8-in. cracked concrete	Spacing factor in tension f_{AN}				Edge distance factor in tension f_{RN}				Spacing factor in shear ⁴ f_{AV}				Edge distance in shear								Concrete thickness factor in shear ⁵ f_{HV}			
													⊥ Toward edge f_{RV}				To and away from edge f_{RV}							
Embedment in. h_{ef} (mm)	2-3/8 (60)	3-3/8 (86)	4-1/2 (114)	7-1/2 (191)	2-3/8 (60)	3-3/8 (86)	4-1/2 (114)	7-1/2 (191)	2-3/8 (60)	3-3/8 (86)	4-1/2 (114)	7-1/2 (191)	2-3/8 (60)	3-3/8 (86)	4-1/2 (114)	7-1/2 (191)	2-3/8 (60)	3-3/8 (86)	4-1/2 (114)	7-1/2 (191)	2-3/8 (60)	3-3/8 (86)	4-1/2 (114)	7-1/2 (191)
1-3/4 (44)	n/a	n/a	n/a	n/a	0.50	0.50	0.49	0.43	n/a	n/a	n/a	n/a	0.23	0.07	0.06	0.03	0.46	0.15	0.11	0.07	n/a	n/a	n/a	n/a
1-7/8 (48)	0.58	0.58	0.57	0.54	0.52	0.52	0.50	0.44	0.57	0.53	0.53	0.52	0.26	0.08	0.06	0.04	0.51	0.16	0.12	0.07	n/a	n/a	n/a	n/a
2 (51)	0.58	0.58	0.57	0.54	0.53	0.53	0.51	0.44	0.57	0.53	0.53	0.52	0.28	0.09	0.07	0.04	0.53	0.18	0.14	0.08	n/a	n/a	n/a	n/a
3 (76)	0.62	0.62	0.61	0.57	0.63	0.63	0.60	0.49	0.61	0.55	0.54	0.53	0.52	0.17	0.12	0.07	0.63	0.33	0.25	0.15	n/a	n/a	n/a	n/a
3-5/8 (92)	0.65	0.65	0.63	0.58	0.70	0.70	0.66	0.53	0.63	0.56	0.55	0.54	0.69	0.22	0.17	0.10	0.70	0.44	0.33	0.20	0.72	n/a	n/a	n/a
4 (102)	0.66	0.66	0.65	0.59	0.74	0.74	0.70	0.55	0.64	0.57	0.56	0.54	0.80	0.26	0.19	0.11	0.74	0.51	0.38	0.23	0.76	n/a	n/a	n/a
4-5/8 (117)	0.69	0.69	0.67	0.60	0.81	0.81	0.76	0.58	0.67	0.58	0.56	0.55	0.99	0.32	0.24	0.14	0.81	0.63	0.48	0.29	0.81	0.56	n/a	n/a
5 (127)	0.70	0.70	0.69	0.61	0.86	0.86	0.80	0.60	0.68	0.58	0.57	0.55	1.00	0.36	0.27	0.16	0.86	0.71	0.54	0.32	0.85	0.58	n/a	n/a
5-3/4 (146)	0.73	0.73	0.71	0.63	0.95	0.95	0.88	0.64	0.71	0.60	0.58	0.56		0.44	0.33	0.20	0.95	0.88	0.66	0.40	0.91	0.62	0.56	n/a
6 (152)	0.74	0.74	0.72	0.63	0.98	0.98	0.91	0.66	0.71	0.60	0.58	0.56		0.47	0.35	0.21	0.98	0.94	0.70	0.42	0.93	0.63	0.58	n/a
7 (178)	0.78	0.78	0.76	0.66	1.00	1.00	1.00	0.72	0.75	0.62	0.60	0.57		0.59	0.44	0.27	1.00	1.00	0.89	0.53	1.00	0.69	0.62	n/a
8 (203)	0.82	0.82	0.80	0.68				0.78	0.79	0.63	0.61	0.58		0.72	0.54	0.32			1.00	0.65		0.73	0.67	n/a
8-3/4 (222)	0.86	0.86	0.82	0.69				0.83	0.81	0.65	0.62	0.59		0.83	0.62	0.37				0.74		0.77	0.70	0.59
9 (229)	0.87	0.87	0.83	0.70				0.85	0.82	0.65	0.62	0.59		0.86	0.65	0.39				0.78		0.78	0.71	0.60
10 (254)	0.91	0.91	0.87	0.72				0.91	0.86	0.67	0.64	0.60		1.00	0.76	0.45				0.91		0.82	0.74	0.63
11 (279)	0.95	0.95	0.91	0.74				0.98	0.89	0.68	0.65	0.61			0.87	0.52				0.98		0.86	0.78	0.66
12 (305)	0.99	0.99	0.94	0.77				1.00	0.93	0.70	0.67	0.62			1.00	0.60				1.00		0.90	0.82	0.69
14 (356)	1.00	1.00	1.00	0.81				1.00	0.73	0.69	0.64					0.75						0.97	0.88	0.74
16 (406)				0.86					0.77	0.72	0.66					0.92						1.00	0.94	0.79
18 (457)				0.90					0.80	0.75	0.68					1.00							1.00	0.84
24 (610)				1.00					0.90	0.83	0.74													0.97
30 (762)									1.00	0.92	0.80													1.00
36 (914)										1.00	0.85													
> 48 (1219)											0.97													

1 Linear interpolation not permitted

2 Shaded area with reduced edge distance is permitted provided the installation torque is reduced to 0.30 T_{max} for 5d ≤ s ≤ 16-in. and to 0.5 T_{max} for s > 16-in.

3 When combining multiple load adjustment factors (e.g. for a four-anchor pattern in a corner with thin concrete member) the design can become very conservative. To optimize the design, use Hilti PROFIS Anchor Design software or perform anchor calculation using design equations from ACI 318 Chapter 17.

4 Spacing factor reduction in shear, f_{AV} , assumes an influence of a nearby edge. If no edge exists, then $f_{AV} = f_{AN}$.

5 Concrete thickness reduction factor in shear, f_{HV} , assumes an influence of a nearby edge. If no edge exists, then $f_{HV} = 1.0$.

HIT-RE 500 V3 Epoxy Adhesive Anchoring System 3.2.4

Table 32 - Load adjustment factors for 1/2-in. diameter threaded rods in uncracked concrete^{1,2,3}

1/2-in. uncracked concrete	Spacing factor in tension f_{AN}				Edge distance factor in tension f_{RN}				Spacing factor in shear ⁴ f_{AV}				Edge distance in shear								Concrete thickness factor in shear ⁵ f_{HV}			
													⊥ Toward edge f_{RV}				∥ To and away from edge f_{RV}							
Embedment in. h_{ef} (mm)	2-3/4 (70)	4-1/2 (114)	6 (152)	10 (254)	2-3/4 (70)	4-1/2 (114)	6 (152)	10 (254)	2-3/4 (70)	4-1/2 (114)	6 (152)	10 (254)	2-3/4 (70)	4-1/2 (114)	6 (152)	10 (254)	2-3/4 (70)	4-1/2 (114)	6 (152)	10 (254)	2-3/4 (70)	4-1/2 (114)	6 (152)	10 (254)
1-3/4 (44)	n/a	n/a	n/a	n/a	0.34	0.24	0.19	0.11	n/a	n/a	n/a	n/a	0.10	0.05	0.03	0.02	0.21	0.11	0.07	0.03	n/a	n/a	n/a	n/a
2-1/2 (64)	0.58	0.58	0.57	0.54	0.41	0.28	0.22	0.13	0.55	0.53	0.53	0.52	0.18	0.09	0.06	0.03	0.35	0.18	0.12	0.06	n/a	n/a	n/a	n/a
3 (76)	0.59	0.59	0.58	0.55	0.46	0.30	0.23	0.14	0.56	0.54	0.53	0.52	0.23	0.12	0.08	0.04	0.46	0.24	0.15	0.08	n/a	n/a	n/a	n/a
4 (102)	0.62	0.62	0.61	0.57	0.57	0.35	0.26	0.15	0.58	0.55	0.54	0.53	0.36	0.18	0.12	0.06	0.57	0.35	0.24	0.12	0.58	n/a	n/a	n/a
5 (127)	0.65	0.65	0.64	0.58	0.71	0.40	0.30	0.17	0.60	0.57	0.55	0.53	0.50	0.26	0.17	0.08	0.71	0.40	0.31	0.16	0.65	n/a	n/a	n/a
5-3/4 (146)	0.68	0.68	0.66	0.60	0.78	0.44	0.33	0.19	0.62	0.58	0.56	0.54	0.61	0.32	0.21	0.10	0.81	0.44	0.34	0.20	0.69	0.56	n/a	n/a
6 (152)	0.69	0.69	0.67	0.60	0.80	0.46	0.33	0.20	0.63	0.58	0.56	0.54	0.65	0.34	0.22	0.11	0.85	0.46	0.35	0.21	0.71	0.57	n/a	n/a
7 (178)	0.72	0.72	0.69	0.62	0.90	0.52	0.37	0.22	0.65	0.59	0.57	0.54	0.82	0.42	0.28	0.13	0.99	0.52	0.38	0.27	0.77	0.61	n/a	n/a
7-1/4 (184)	0.72	0.72	0.70	0.62	0.92	0.54	0.38	0.22	0.65	0.60	0.57	0.55	0.87	0.45	0.29	0.14	1.00	0.54	0.39	0.28	0.78	0.62	0.54	n/a
8 (203)	0.75	0.75	0.72	0.63	0.99	0.59	0.41	0.24	0.67	0.61	0.58	0.55	1.00	0.52	0.34	0.16		0.59	0.42	0.30	0.82	0.66	0.57	n/a
9 (229)	0.78	0.78	0.75	0.65	1.00	0.67	0.46	0.27	0.69	0.62	0.59	0.56		0.62	0.40	0.20		0.67	0.46	0.32	0.87	0.70	0.60	n/a
10 (254)	0.81	0.81	0.78	0.67		0.74	0.52	0.30	0.71	0.63	0.60	0.56		0.72	0.47	0.23		0.74	0.52	0.34	0.92	0.73	0.64	n/a
11-1/4 (286)	0.85	0.85	0.81	0.69		0.83	0.58	0.34	0.74	0.65	0.61	0.57		0.86	0.56	0.27		0.83	0.58	0.37	0.97	0.78	0.67	0.53
12 (305)	0.87	0.87	0.83	0.70		0.89	0.62	0.36	0.75	0.66	0.62	0.58		0.95	0.62	0.30		0.89	0.62	0.38	1.00	0.80	0.70	0.55
14 (356)	0.93	0.93	0.89	0.73		1.00	0.72	0.42	0.79	0.69	0.64	0.59		1.00	0.78	0.38		1.00	0.72	0.43		0.87	0.75	0.59
16 (406)	1.00	1.00	0.94	0.77			0.82	0.48	0.83	0.72	0.66	0.60			0.95	0.47			0.82	0.48		0.93	0.80	0.63
18 (457)			1.00	0.80			0.93	0.54	0.88	0.74	0.68	0.61			1.00	0.56			0.93	0.54		0.98	0.85	0.67
20 (508)				0.83			1.00	0.60	0.92	0.77	0.70	0.63				0.65			1.00	0.60		1.00	0.90	0.71
22 (559)				0.87				0.66	0.96	0.80	0.72	0.64				0.75				0.66			0.94	0.74
24 (610)				0.90				0.72	1.00	0.82	0.74	0.65				0.85				0.72			0.98	0.77
30 (762)				1.00				0.90		0.90	0.80	0.69				1.00				0.90			1.00	0.87
36 (914)								1.00		0.98	0.86	0.73								1.00				0.95
> 48 (1219)										1.00	0.98	0.80												1.00

3.2.4

Table 33 - Load adjustment factors for 1/2-in. diameter threaded rods in cracked concrete^{1,2,3}

1/2-in. cracked concrete	Spacing factor in tension f_{AN}				Edge distance factor in tension f_{RN}				Spacing factor in shear ⁴ f_{AV}				Edge distance in shear								Concrete thickness factor in shear ⁵ f_{HV}			
													⊥ Toward edge f_{RV}				∥ To and away from edge f_{RV}							
Embedment in. h_{ef} (mm)	2-3/4 (70)	4-1/2 (114)	6 (152)	10 (254)	2-3/4 (70)	4-1/2 (114)	6 (152)	10 (254)	2-3/4 (70)	4-1/2 (114)	6 (152)	10 (254)	2-3/4 (70)	4-1/2 (114)	6 (152)	10 (254)	2-3/4 (70)	4-1/2 (114)	6 (152)	10 (254)	2-3/4 (70)	4-1/2 (114)	6 (152)	10 (254)
1-3/4 (44)	n/a	n/a	n/a	n/a	0.47	0.47	0.45	0.41	n/a	n/a	n/a	n/a	0.10	0.05	0.04	0.02	0.21	0.11	0.07	0.04	n/a	n/a	n/a	n/a
2-1/2 (64)	0.58	0.58	0.57	0.54	0.52	0.52	0.50	0.44	0.55	0.53	0.53	0.52	0.18	0.09	0.06	0.04	0.35	0.18	0.12	0.07	n/a	n/a	n/a	n/a
3 (76)	0.59	0.59	0.58	0.55	0.56	0.56	0.53	0.46	0.56	0.54	0.53	0.52	0.23	0.12	0.08	0.05	0.47	0.24	0.16	0.10	n/a	n/a	n/a	n/a
4 (102)	0.62	0.62	0.61	0.57	0.63	0.63	0.60	0.49	0.58	0.55	0.54	0.53	0.36	0.18	0.13	0.08	0.72	0.37	0.25	0.15	0.58	n/a	n/a	n/a
5 (127)	0.65	0.65	0.64	0.58	0.72	0.72	0.67	0.53	0.61	0.57	0.55	0.54	0.50	0.26	0.18	0.11	1.00	0.52	0.35	0.21	0.65	n/a	n/a	n/a
5-3/4 (146)	0.68	0.68	0.66	0.60	0.78	0.78	0.73	0.56	0.62	0.58	0.56	0.54	0.62	0.32	0.22	0.13		0.64	0.43	0.26	0.70	0.56	n/a	n/a
6 (152)	0.69	0.69	0.67	0.60	0.80	0.80	0.75	0.57	0.63	0.58	0.56	0.54	0.66	0.34	0.23	0.14		0.68	0.46	0.28	0.71	0.57	n/a	n/a
7 (178)	0.72	0.72	0.69	0.62	0.90	0.90	0.83	0.62	0.65	0.59	0.57	0.55	0.83	0.43	0.29	0.17		0.86	0.58	0.35	0.77	0.62	n/a	n/a
7-1/4 (184)	0.72	0.72	0.70	0.62	0.92	0.92	0.85	0.63	0.65	0.60	0.58	0.55	0.88	0.45	0.31	0.18		0.90	0.61	0.37	0.78	0.63	0.55	n/a
8 (203)	0.75	0.75	0.72	0.63	0.99	0.99	0.91	0.66	0.67	0.61	0.58	0.56	1.00	0.52	0.35	0.21		1.00	0.71	0.43	0.82	0.66	0.58	n/a
9 (229)	0.78	0.78	0.75	0.65	1.00	1.00	1.00	0.70	0.69	0.62	0.59	0.57		0.62	0.42	0.25			0.85	0.51	0.87	0.70	0.61	n/a
10 (254)	0.81	0.81	0.78	0.67				0.75	0.71	0.64	0.60	0.57		0.73	0.50	0.30			0.99	0.59	0.92	0.74	0.65	n/a
11-1/4 (286)	0.85	0.85	0.81	0.69				0.81	0.74	0.65	0.62	0.58		0.87	0.59	0.35			1.00	0.71	0.97	0.78	0.69	0.58
12 (305)	0.87	0.87	0.83	0.70				0.85	0.75	0.66	0.63	0.59		0.96	0.65	0.39				0.78	1.00	0.81	0.71	0.60
14 (356)	0.93	0.93	0.89	0.73				0.95	0.79	0.69	0.65	0.60		1.00	0.82	0.49				0.95		0.87	0.76	0.64
16 (406)	1.00	1.00	0.94	0.77				1.00	0.84	0.72	0.67	0.62			1.00	0.60				1.00		0.93	0.82	0.69
18 (457)			1.00	0.80					0.88	0.74	0.69	0.63				0.72						0.99	0.87	0.73
20 (508)				0.83					0.92	0.77	0.71	0.65				0.84						1.00	0.91	0.77
22 (559)				0.87					0.96	0.80	0.73	0.66				0.97							0.96	0.81
24 (610)				0.90					1.00	0.82	0.75	0.68				1.00							1.00	0.84
30 (762)				1.00						0.91	0.81	0.72												0.94
36 (914)										0.99	0.88	0.77												1.00
> 48 (1219)										1.00	1.00	0.86												

1 Linear interpolation not permitted.
 2 Shaded area with reduced edge distance is permitted provided the installation torque is reduced to 0.30 T_{max} for 5d ≤ s ≤ 16-in. and to 0.5 T_{max} for s > 16-in.
 3 When combining multiple load adjustment factors (e.g. for a 4 anchor pattern in a corner with a thin concrete member) the design can become very conservative. To optimize the design, use Hilti PROFIS Anchor Design software or perform anchor calculation using the design equations from ACI 318 Chapter 17.
 4 Spacing factor reduction in shear, f_{AV} , assumes an influence of a nearby edge. If no edge exists, then $f_{AV} = f_{AN}$.
 5 Concrete thickness reduction factor in shear, f_{HV} , assumes an influence of a nearby edge. If no edge exists, then $f_{HV} = 1.0$.

3.2.4 HIT-RE 500 V3 Epoxy Adhesive Anchoring System

Table 34 - Load adjustment factors for 5/8-in. diameter threaded rods in uncracked concrete^{1,2,3}

5/8-in. uncracked concrete	Spacing factor in tension f_{AN}				Edge distance factor in tension f_{RN}				Spacing factor in shear ⁴ f_{AV}				Edge distance in shear								Concrete thickness factor in shear ⁵ f_{HV}							
													⊥ Toward edge f_{RV}				∥ To and away from edge f_{RV}											
													3-1/8	5-5/8	7-1/2	12-1/2	3-1/8	5-5/8	7-1/2	12-1/2					3-1/8	5-5/8	7-1/2	12-1/2
Embedment in. h_{ef} (mm)	(79)	(143)	(191)	(318)	(79)	(143)	(191)	(318)	(79)	(143)	(191)	(318)	(79)	(143)	(191)	(318)	(79)	(143)	(191)	(318)	(79)	(143)	(191)	(318)				
1-3/4 (44)	n/a	n/a	n/a	n/a	0.35	0.24	0.19	0.11	n/a	n/a	n/a	n/a	0.09	0.04	0.03	0.01	0.19	0.08	0.06	0.03	0.18	0.08	0.06	0.03	n/a	n/a	n/a	n/a
3-1/8 (79)	0.58	0.58	0.57	0.54	0.47	0.29	0.22	0.13	0.56	0.54	0.53	0.52	0.22	0.10	0.07	0.03	0.45	0.20	0.13	0.06	n/a	n/a	n/a	n/a	n/a	n/a	n/a	n/a
4 (102)	0.60	0.60	0.59	0.55	0.56	0.32	0.24	0.14	0.58	0.55	0.53	0.52	0.32	0.15	0.10	0.04	0.56	0.29	0.19	0.09	n/a	n/a	n/a	n/a	n/a	n/a	n/a	n/a
4-5/8 (117)	0.62	0.62	0.60	0.56	0.62	0.35	0.26	0.15	0.59	0.55	0.54	0.52	0.40	0.18	0.12	0.06	0.62	0.35	0.24	0.11	0.60	n/a	n/a	n/a	n/a	n/a	n/a	n/a
5 (127)	0.63	0.63	0.61	0.57	0.64	0.36	0.27	0.16	0.60	0.56	0.54	0.53	0.45	0.21	0.13	0.06	0.67	0.36	0.27	0.12	0.63	n/a	n/a	n/a	n/a	n/a	n/a	n/a
6 (152)	0.65	0.65	0.63	0.58	0.71	0.41	0.30	0.17	0.62	0.57	0.55	0.53	0.59	0.27	0.18	0.08	0.80	0.41	0.32	0.16	0.69	n/a	n/a	n/a	n/a	n/a	n/a	n/a
7 (178)	0.68	0.68	0.66	0.59	0.78	0.45	0.33	0.19	0.64	0.58	0.56	0.54	0.75	0.34	0.22	0.10	0.94	0.45	0.35	0.21	0.74	n/a	n/a	n/a	n/a	n/a	n/a	n/a
7-1/8 (181)	0.68	0.68	0.66	0.60	0.79	0.46	0.33	0.19	0.64	0.58	0.56	0.54	0.77	0.35	0.23	0.11	0.95	0.46	0.35	0.21	0.75	0.57	n/a	n/a	n/a	n/a	n/a	n/a
8 (203)	0.70	0.70	0.68	0.61	0.85	0.50	0.36	0.21	0.66	0.59	0.57	0.54	0.91	0.41	0.27	0.13	1.00	0.50	0.38	0.25	0.79	0.61	n/a	n/a	n/a	n/a	n/a	n/a
9 (229)	0.73	0.73	0.70	0.62	0.93	0.56	0.39	0.22	0.68	0.60	0.58	0.55	1.00	0.50	0.32	0.15		0.56	0.41	0.29	0.84	0.65	0.56	n/a	n/a	n/a	n/a	n/a
10 (254)	0.75	0.75	0.72	0.63	1.00	0.62	0.43	0.24	0.70	0.62	0.59	0.55		0.58	0.38	0.18		0.62	0.44	0.30	0.89	0.68	0.59	n/a	n/a	n/a	n/a	n/a
11 (279)	0.78	0.78	0.74	0.65		0.68	0.47	0.27	0.72	0.63	0.60	0.56		0.67	0.43	0.20		0.68	0.47	0.32	0.93	0.71	0.62	n/a	n/a	n/a	n/a	n/a
12 (305)	0.80	0.80	0.77	0.66		0.74	0.51	0.29	0.74	0.64	0.60	0.56		0.76	0.50	0.23		0.74	0.51	0.34	0.97	0.75	0.65	n/a	n/a	n/a	n/a	n/a
14 (356)	0.85	0.85	0.81	0.69		0.86	0.60	0.34	0.77	0.66	0.62	0.57		0.96	0.62	0.29		0.86	0.60	0.37	1.00	0.81	0.70	0.54	n/a	n/a	n/a	n/a
16 (406)	0.90	0.90	0.86	0.71		0.99	0.68	0.39	0.81	0.69	0.64	0.58		1.00	0.76	0.35		0.99	0.68	0.41		0.86	0.75	0.58	n/a	n/a	n/a	n/a
18 (457)	0.96	0.96	0.90	0.74		1.00	0.77	0.44	0.85	0.71	0.66	0.59			0.91	0.42		1.00	0.77	0.44		0.91	0.79	0.61	n/a	n/a	n/a	n/a
20 (508)	1.00	1.00	0.94	0.77			0.86	0.49	0.89	0.73	0.67	0.60			1.00	0.50			0.86	0.49		0.96	0.83	0.65	n/a	n/a	n/a	n/a
22 (559)			0.99	0.79			0.94	0.54	0.93	0.75	0.69	0.61				0.57			0.94	0.54		1.00	0.87	0.68	n/a	n/a	n/a	n/a
24 (610)			1.00	0.82			1.00	0.59	0.97	0.78	0.71	0.63				0.65			1.00	0.59			0.91	0.71	n/a	n/a	n/a	n/a
26 (660)				0.85				0.64	1.00	0.80	0.73	0.64				0.73				0.64			0.95	0.74	n/a	n/a	n/a	n/a
28 (711)				0.87				0.68		0.82	0.74	0.65				0.82				0.68			0.99	0.76	n/a	n/a	n/a	n/a
30 (762)				0.90				0.73		0.85	0.76	0.66				0.91				0.73			1.00	0.79	n/a	n/a	n/a	n/a
36 (914)				0.98				0.88		0.92	0.81	0.69				1.00				0.88				0.87	n/a	n/a	n/a	n/a
> 48 (1219)				1.00				1.00		1.00	0.92	0.75								1.00				1.00	n/a	n/a	n/a	n/a

Table 35 - Load adjustment factors for 5/8-in. diameter threaded rods in cracked concrete^{1,2,3}

5/8-in. cracked concrete	Spacing factor in tension f_{AN}				Edge distance factor in tension f_{RN}				Spacing factor in shear ⁴ f_{AV}				Edge distance in shear								Concrete thickness factor in shear ⁵ f_{HV}							
													⊥ Toward edge f_{RV}				∥ To and away from edge f_{RV}											
													3-1/8	5-5/8	7-1/2	12-1/2	3-1/8	5-5/8	7-1/2	12-1/2					3-1/8	5-5/8	7-1/2	12-1/2
Embedment in. h_{ef} (mm)	(79)	(143)	(191)	(318)	(79)	(143)	(191)	(318)	(79)	(143)	(191)	(318)	(79)	(143)	(191)	(318)	(79)	(143)	(191)	(318)	(79)	(143)	(191)	(318)				
1-3/4 (44)	n/a	n/a	n/a	n/a	0.44	0.44	0.43	0.40	n/a	n/a	n/a	n/a	0.09	0.04	0.03	0.02	0.19	0.09	0.06	0.03	0.18	0.08	0.06	0.03	n/a	n/a	n/a	n/a
3-1/8 (79)	0.58	0.58	0.57	0.54	0.52	0.52	0.50	0.44	0.56	0.54	0.53	0.52	0.22	0.10	0.07	0.04	0.45	0.20	0.13	0.07	n/a	n/a	n/a	n/a	n/a	n/a	n/a	n/a
4 (102)	0.60	0.60	0.59	0.55	0.58	0.58	0.55	0.46	0.58	0.55	0.53	0.52	0.33	0.15	0.10	0.05	0.65	0.30	0.19	0.11	n/a	n/a	n/a	n/a	n/a	n/a	n/a	n/a
4-5/8 (117)	0.62	0.62	0.60	0.56	0.62	0.62	0.58	0.48	0.59	0.55	0.54	0.53	0.40	0.18	0.12	0.07	0.81	0.37	0.24	0.13	0.60	n/a	n/a	n/a	n/a	n/a	n/a	n/a
5 (127)	0.63	0.63	0.61	0.57	0.64	0.64	0.60	0.49	0.60	0.56	0.54	0.53	0.45	0.21	0.13	0.08	0.91	0.41	0.27	0.15	0.63	n/a	n/a	n/a	n/a	n/a	n/a	n/a
6 (152)	0.65	0.65	0.63	0.58	0.71	0.71	0.66	0.53	0.62	0.57	0.55	0.54	0.60	0.27	0.18	0.10	1.00	0.54	0.35	0.20	0.69	n/a	n/a	n/a	n/a	n/a	n/a	n/a
7 (178)	0.68	0.68	0.66	0.59	0.78	0.78	0.72	0.56	0.64	0.58	0.56	0.54	0.75	0.34	0.22	0.13		0.68	0.44	0.25	0.74	n/a	n/a	n/a	n/a	n/a	n/a	n/a
7-1/8 (181)	0.68	0.68	0.66	0.60	0.79	0.79	0.73	0.56	0.64	0.58	0.56	0.54	0.77	0.35	0.23	0.13		0.70	0.46	0.26	0.75	0.58	n/a	n/a	n/a	n/a	n/a	n/a
8 (203)	0.70	0.70	0.68	0.61	0.85	0.85	0.78	0.59	0.66	0.59	0.57	0.55	0.92	0.42	0.27	0.15		0.84	0.54	0.31	0.79	0.61	n/a	n/a	n/a	n/a	n/a	n/a
9 (229)	0.73	0.73	0.70	0.62	0.93	0.93	0.85	0.62	0.68	0.60	0.58	0.55	1.00	0.50	0.32	0.18		1.00	0.65	0.37	0.84	0.65	0.56	n/a	n/a	n/a	n/a	n/a
10 (254)	0.75	0.75	0.72	0.63	1.00	1.00	0.91	0.66	0.70	0.62	0.59	0.56		0.58	0.38	0.21			0.76	0.43	0.89	0.68	0.59	n/a	n/a	n/a	n/a	n/a
11 (279)	0.78	0.78	0.74	0.65			0.98	0.69	0.72	0.63	0.60	0.57		0.67	0.44	0.25			0.88	0.49	0.93	0.72	0.62	n/a	n/a	n/a	n/a	n/a
12 (305)	0.80	0.80	0.77	0.66			1.00	0.73	0.74	0.64	0.60	0.57		0.77	0.50	0.28			1.00	0.56	0.97	0.75	0.65	n/a	n/a	n/a	n/a	n/a
14 (356)	0.85	0.85	0.81	0.69				0.81	0.78	0.66	0.62	0.58		0.97	0.63	0.36				0.71	1.00	0.81	0.70	0.58	n/a	n/a	n/a	n/a
16 (406)	0.90	0.90	0.86	0.71				0.89	0.82	0.69	0.64	0.60		1.00	0.77	0.43				0.87		0.86	0.75	0.62	n/a	n/a	n/a	n/a
18 (457)	0.96	0.96	0.90	0.74				0.97	0.85	0.71	0.66	0.61			0.92	0.52				0.97		0.92	0.79	0.66	n/a	n/a	n/a	n/a
20 (508)	1.00	1.00	0.94	0.77				1.00	0.89	0.73	0.67	0.62			1.00	0.61				1.00		0.97	0.84	0.69	n/a	n/a	n/a	n/a
22 (559)			0.99	0.79					0.93	0.76	0.69	0.63				0.70						1.00	0.88	0.72	n/a	n/a	n/a	n/a
24 (610)			1.00	0.82					0.97	0.78	0.71	0.64				0.80							0.92	0.76	n/a	n/a	n/a	n/a
26 (660)				0.85					1.00	0.80	0.73	0.66				0.90							0.95	0.79	n/a	n/a	n/a	n/a
28 (711)				0.87						0.83	0.74	0.67				1.00							0.99	0.82	n/a	n/a	n/a	n/a
30 (762)				0.90						0.85	0.76	0.68											1.00	0.85	n/a	n/a	n/a	n/a
36 (914)				0.98		</																						

HIT-RE 500 V3 Epoxy Adhesive Anchoring System 3.2.4

Table 36 - Load adjustment factors for 3/4-in. diameter threaded rods in uncracked concrete^{1,2,3}

3/4-in. uncracked concrete	Spacing factor in tension f_{AN}				Edge distance factor in tension f_{RN}				Spacing factor in shear ⁴ f_{AV}				Edge distance in shear								Concrete thickness factor in shear ⁵ f_{HV}			
													⊥ Toward edge f_{RV}				To and away from edge f_{RV}							
	Embedment in. h_{ef} (mm)	3-1/2 (89)	6-3/4 (171)	9 (229)	15 (381)	3-1/2 (89)	6-3/4 (171)	9 (229)	15 (381)	3-1/2 (89)	6-3/4 (171)	9 (229)	15 (381)	3-1/2 (89)	6-3/4 (171)	9 (229)	15 (381)	3-1/2 (89)	6-3/4 (171)	9 (229)	15 (381)	3-1/2 (89)	6-3/4 (171)	9 (229)
1-3/4 (44)	n/a	n/a	n/a	n/a	0.35	0.24	0.18	0.10	n/a	n/a	n/a	n/a	0.09	0.03	0.02	0.01	0.17	0.07	0.05	0.02	n/a	n/a	n/a	n/a
3-3/4 (95)	0.58	0.58	0.57	0.54	0.52	0.30	0.23	0.13	0.57	0.54	0.53	0.52	0.27	0.11	0.07	0.03	0.52	0.22	0.14	0.07	n/a	n/a	n/a	n/a
4 (102)	0.59	0.59	0.57	0.54	0.54	0.31	0.23	0.13	0.57	0.54	0.53	0.52	0.29	0.12	0.08	0.04	0.54	0.24	0.16	0.07	n/a	n/a	n/a	n/a
5 (127)	0.61	0.61	0.59	0.56	0.59	0.34	0.25	0.14	0.59	0.55	0.54	0.52	0.41	0.17	0.11	0.05	0.64	0.33	0.22	0.10	n/a	n/a	n/a	n/a
5-1/4 (133)	0.61	0.61	0.60	0.56	0.61	0.35	0.26	0.15	0.60	0.55	0.54	0.52	0.44	0.18	0.12	0.05	0.66	0.35	0.23	0.11	0.62	n/a	n/a	n/a
6 (152)	0.63	0.63	0.61	0.57	0.65	0.38	0.28	0.16	0.61	0.56	0.55	0.53	0.54	0.22	0.14	0.07	0.76	0.38	0.29	0.13	0.66	n/a	n/a	n/a
7 (178)	0.65	0.65	0.63	0.58	0.70	0.41	0.30	0.17	0.63	0.57	0.55	0.53	0.68	0.28	0.18	0.08	0.89	0.41	0.32	0.17	0.72	n/a	n/a	n/a
8 (203)	0.67	0.67	0.65	0.59	0.76	0.45	0.33	0.18	0.65	0.58	0.56	0.54	0.83	0.34	0.22	0.10	1.00	0.45	0.35	0.20	0.77	n/a	n/a	n/a
8-1/2 (216)	0.68	0.68	0.66	0.59	0.79	0.47	0.34	0.19	0.66	0.59	0.56	0.54	0.91	0.37	0.24	0.11		0.47	0.36	0.22	0.79	0.59	n/a	n/a
9 (229)	0.69	0.69	0.67	0.60	0.83	0.49	0.35	0.20	0.67	0.59	0.57	0.54	0.99	0.40	0.26	0.12		0.49	0.37	0.24	0.81	0.60	n/a	n/a
10 (254)	0.71	0.71	0.69	0.61	0.89	0.53	0.38	0.21	0.68	0.60	0.58	0.55	1.00	0.47	0.31	0.14		0.53	0.40	0.28	0.86	0.64	n/a	n/a
10-3/4 (273)	0.73	0.73	0.70	0.62	0.94	0.57	0.40	0.23	0.70	0.61	0.58	0.55		0.53	0.34	0.16		0.57	0.42	0.29	0.89	0.66	0.57	n/a
12 (305)	0.76	0.76	0.72	0.63	1.00	0.64	0.44	0.25	0.72	0.62	0.59	0.55		0.62	0.40	0.19		0.64	0.45	0.31	0.94	0.70	0.60	n/a
14 (356)	0.80	0.80	0.76	0.66		0.74	0.52	0.29	0.76	0.64	0.61	0.56		0.78	0.51	0.24		0.74	0.52	0.33	1.00	0.75	0.65	n/a
16 (406)	0.84	0.84	0.80	0.68		0.85	0.59	0.33	0.79	0.66	0.62	0.57		0.96	0.62	0.29		0.85	0.59	0.36		0.80	0.70	n/a
16-3/4 (425)	0.86	0.86	0.81	0.69		0.89	0.62	0.35	0.81	0.67	0.63	0.58		1.00	0.67	0.31		0.89	0.62	0.37		0.82	0.71	0.55
18 (457)	0.89	0.89	0.83	0.70		0.96	0.66	0.37	0.83	0.68	0.64	0.58			0.74	0.35		0.96	0.66	0.39		0.85	0.74	0.57
20 (508)	0.93	0.93	0.87	0.72		1.00	0.74	0.41	0.87	0.70	0.65	0.59			0.87	0.40		1.00	0.74	0.42		0.90	0.78	0.60
22 (559)	0.97	0.97	0.91	0.74			0.81	0.45	0.91	0.72	0.67	0.60			1.00	0.47			0.81	0.46		0.94	0.82	0.63
24 (610)	1.00	1.00	0.94	0.77			0.89	0.50	0.94	0.74	0.68	0.61				0.53			0.89	0.50		0.99	0.85	0.66
26 (660)			0.98	0.79			0.96	0.54	0.98	0.76	0.70	0.62				0.60			0.96	0.54		1.00	0.89	0.69
28 (711)			1.00	0.81			1.00	0.58	1.00	0.78	0.71	0.63				0.67			1.00	0.58			0.92	0.71
30 (762)				0.83				0.62		0.80	0.73	0.64				0.74				0.62			0.95	0.74
36 (914)				0.90				0.74		0.86	0.77	0.66				0.98				0.74			1.00	0.81
> 48 (1219)				1.00				0.99		0.99	0.86	0.72				1.00				0.99				0.94

3.2.4

Table 37 - Load adjustment factors for 3/4-in. diameter threaded rods in cracked concrete^{1,2,3}

3/4-in. cracked concrete	Spacing factor in tension f_{AN}				Edge distance factor in tension f_{RN}				Spacing factor in shear ⁴ f_{AV}				Edge distance in shear								Concrete thickness factor in shear ⁵ f_{HV}			
													⊥ Toward edge f_{RV}				To and away from edge f_{RV}							
	Embedment in. h_{ef} (mm)	3-1/2 (89)	6-3/4 (171)	9 (229)	15 (381)	3-1/2 (89)	6-3/4 (171)	9 (229)	15 (381)	3-1/2 (89)	6-3/4 (171)	9 (229)	15 (381)	3-1/2 (89)	6-3/4 (171)	9 (229)	15 (381)	3-1/2 (89)	6-3/4 (171)	9 (229)	15 (381)	3-1/2 (89)	6-3/4 (171)	9 (229)
1-3/4 (44)	n/a	n/a	n/a	n/a	0.43	0.43	0.42	0.39	n/a	n/a	n/a	n/a	0.09	0.03	0.02	0.01	0.17	0.07	0.05	0.02	n/a	n/a	n/a	n/a
3-3/4 (95)	0.58	0.58	0.57	0.54	0.53	0.53	0.50	0.44	0.57	0.54	0.53	0.52	0.27	0.11	0.07	0.04	0.54	0.22	0.14	0.07	n/a	n/a	n/a	n/a
4 (102)	0.59	0.59	0.57	0.54	0.54	0.54	0.51	0.44	0.57	0.54	0.53	0.52	0.30	0.12	0.08	0.04	0.59	0.24	0.16	0.08	n/a	n/a	n/a	n/a
5 (127)	0.61	0.61	0.59	0.56	0.59	0.59	0.56	0.47	0.59	0.55	0.54	0.52	0.41	0.17	0.11	0.06	0.83	0.34	0.22	0.11	n/a	n/a	n/a	n/a
5-1/4 (133)	0.61	0.61	0.60	0.56	0.61	0.61	0.57	0.47	0.60	0.55	0.54	0.53	0.45	0.18	0.12	0.06	0.89	0.36	0.24	0.12	0.62	n/a	n/a	n/a
6 (152)	0.63	0.63	0.61	0.57	0.65	0.65	0.60	0.49	0.61	0.56	0.55	0.53	0.54	0.22	0.14	0.07	1.00	0.44	0.29	0.15	0.67	n/a	n/a	n/a
7 (178)	0.65	0.65	0.63	0.58	0.70	0.70	0.65	0.52	0.63	0.57	0.55	0.53	0.69	0.28	0.18	0.09		0.56	0.36	0.19	0.72	n/a	n/a	n/a
8 (203)	0.67	0.67	0.65	0.59	0.76	0.76	0.70	0.55	0.65	0.58	0.56	0.54	0.84	0.34	0.22	0.12		0.68	0.44	0.23	0.77	n/a	n/a	n/a
8-1/2 (216)	0.68	0.68	0.66	0.59	0.79	0.79	0.72	0.56	0.66	0.59	0.56	0.54	0.92	0.37	0.24	0.13		0.75	0.49	0.25	0.79	0.59	n/a	n/a
9 (229)	0.69	0.69	0.67	0.60	0.83	0.83	0.75	0.57	0.67	0.59	0.57	0.54	1.00	0.41	0.26	0.14		0.82	0.53	0.28	0.82	0.61	n/a	n/a
10 (254)	0.71	0.71	0.69	0.61	0.89	0.89	0.80	0.60	0.69	0.60	0.58	0.55		0.48	0.31	0.16		0.95	0.62	0.32	0.86	0.64	n/a	n/a
10-3/4 (273)	0.73	0.73	0.70	0.62	0.94	0.94	0.84	0.62	0.70	0.61	0.58	0.55		0.53	0.35	0.18		1.00	0.69	0.36	0.89	0.66	0.57	n/a
12 (305)	0.76	0.76	0.72	0.63	1.00	1.00	0.91	0.66	0.72	0.62	0.59	0.56		0.63	0.41	0.21			0.82	0.42	0.94	0.70	0.61	n/a
14 (356)	0.80	0.80	0.76	0.66			1.00	0.72	0.76	0.64	0.61	0.57		0.79	0.51	0.27			1.00	0.53	1.00	0.76	0.65	n/a
16 (406)	0.84	0.84	0.80	0.68				0.78	0.80	0.66	0.62	0.58		0.97	0.63	0.33				0.65		0.81	0.70	n/a
16-3/4 (425)	0.86	0.86	0.81	0.69				0.81	0.81	0.67	0.63	0.58		1.00	0.67	0.35				0.70		0.83	0.72	0.57
18 (457)	0.89	0.89	0.83	0.70				0.85	0.83	0.68	0.64	0.59			0.75	0.39				0.78		0.86	0.74	0.60
20 (508)	0.93	0.93	0.87	0.72				0.91	0.87	0.70	0.65	0.60			0.88	0.46				0.91		0.90	0.78	0.63
22 (559)	0.97	0.97	0.91	0.74				0.98	0.91	0.72	0.67	0.61			1.00	0.53				0.98		0.95	0.82	0.66
24 (610)	1.00	1.00	0.94	0.77				1.00	0.94	0.74	0.68	0.62				0.60				1.00		0.99	0.86	0.69
26 (660)			0.98	0.79					0.98	0.76	0.70	0.63				0.68						1.00	0.89	0.72
28 (711)			1.00	0.81					1.00	0.79	0.71	0.64				0.75							0.92	0.74
30 (762)				0.83						0.81	0.73	0.65				0.84							0.96	0.77
36 (914)				0.90						0.87	0.77	0.68				1.00							1.00	0.84
> 48 (1219)				1.00						0.99	0.87	0.74												0.97

1 Linear interpolation not permitted.

 2 Shaded area with reduced edge distance is permitted provided the installation torque is reduced to 0.30 T_{max} for 5d ≤ s ≤ 16-in. and to 0.5 T_{max} for s > 16-in.

3 When combining multiple load adjustment factors (e.g. for a 4 anchor pattern in a corner with a thin concrete member) the design can become very conservative. To optimize the design, use Hilti PROFIS Anchor Design software or perform anchor calculation using the design equations from ACI 318 Chapter 17.

 4 Spacing factor reduction in shear, f_{AV} , assumes an influence of a nearby edge. If no edge exists, then $f_{AV} = f_{AN}$.

 5 Concrete thickness reduction factor in shear, f_{HV} , assumes an influence of a nearby edge. If no edge exists, then $f_{HV} = 1.0$.

3.2.4 HIT-RE 500 V3 Epoxy Adhesive Anchoring System

Table 38 - Load adjustment factors for 7/8-in. diameter threaded rods in uncracked concrete^{1,2,3}

7/8-in. uncracked concrete	Spacing factor in tension f_{AN}				Edge distance factor in tension f_{RN}				Spacing factor in shear ⁴ f_{AV}				Edge distance in shear								Concrete thickness factor in shear ⁵ f_{HV}			
													⊥ Toward edge f_{RV}				∥ To and away from edge f_{RV}							
Embedment in. h_{ef} (mm)	3-1/2 (89)	7-7/8 (200)	10-1/2 (267)	17-1/2 (445)	3-1/2 (89)	7-7/8 (200)	10-1/2 (267)	17-1/2 (445)	3-1/2 (89)	7-7/8 (200)	10-1/2 (267)	17-1/2 (445)	3-1/2 (89)	7-7/8 (200)	10-1/2 (267)	17-1/2 (445)	3-1/2 (89)	7-7/8 (200)	10-1/2 (267)	17-1/2 (445)	3-1/2 (89)	7-7/8 (200)	10-1/2 (267)	17-1/2 (445)
1-3/4 (44)	n/a	n/a	n/a	n/a	0.39	0.24	0.18	0.10	n/a	n/a	n/a	n/a	0.09	0.03	0.02	0.01	0.18	0.05	0.04	0.02	n/a	n/a	n/a	n/a
4-3/8 (111)	0.58	0.58	0.57	0.54	0.53	0.31	0.23	0.13	0.58	0.54	0.53	0.52	0.35	0.11	0.07	0.03	0.63	0.22	0.14	0.07	n/a	n/a	n/a	n/a
5 (127)	0.59	0.59	0.58	0.55	0.56	0.33	0.24	0.13	0.59	0.54	0.53	0.52	0.43	0.13	0.09	0.04	0.70	0.27	0.17	0.08	n/a	n/a	n/a	n/a
5-1/2 (140)	0.60	0.60	0.59	0.55	0.58	0.34	0.25	0.14	0.60	0.55	0.54	0.52	0.50	0.15	0.10	0.05	0.76	0.31	0.20	0.09	0.65	n/a	n/a	n/a
6 (152)	0.61	0.61	0.60	0.56	0.61	0.36	0.26	0.15	0.61	0.55	0.54	0.52	0.57	0.17	0.11	0.05	0.83	0.35	0.23	0.11	0.68	n/a	n/a	n/a
7 (178)	0.63	0.63	0.61	0.57	0.65	0.39	0.28	0.16	0.63	0.56	0.55	0.53	0.71	0.22	0.14	0.07	0.97	0.39	0.29	0.13	0.73	n/a	n/a	n/a
8 (203)	0.65	0.65	0.63	0.58	0.71	0.42	0.31	0.17	0.65	0.57	0.55	0.53	0.87	0.27	0.17	0.08	1.00	0.42	0.33	0.16	0.78	n/a	n/a	n/a
9 (229)	0.67	0.67	0.64	0.59	0.76	0.45	0.33	0.18	0.67	0.58	0.56	0.54	1.00	0.32	0.21	0.10		0.45	0.35	0.19	0.83	n/a	n/a	n/a
9-7/8 (251)	0.69	0.69	0.66	0.59	0.80	0.48	0.35	0.19	0.69	0.59	0.56	0.54		0.37	0.24	0.11		0.48	0.37	0.22	0.87	0.59	n/a	n/a
10 (254)	0.69	0.69	0.66	0.60	0.81	0.49	0.35	0.19	0.69	0.59	0.57	0.54		0.38	0.24	0.11		0.49	0.37	0.23	0.87	0.59	n/a	n/a
11 (279)	0.71	0.71	0.67	0.60	0.87	0.52	0.38	0.21	0.71	0.60	0.57	0.54		0.43	0.28	0.13		0.52	0.40	0.26	0.91	0.62	n/a	n/a
12 (305)	0.73	0.73	0.69	0.61	0.92	0.56	0.40	0.22	0.73	0.60	0.58	0.55		0.49	0.32	0.15		0.56	0.42	0.29	0.95	0.65	n/a	n/a
12-1/2 (318)	0.74	0.74	0.70	0.62	0.95	0.59	0.41	0.23	0.74	0.61	0.58	0.55		0.52	0.34	0.16		0.59	0.43	0.29	0.97	0.66	0.57	n/a
14 (356)	0.76	0.76	0.72	0.63	1.00	0.66	0.46	0.25	0.77	0.62	0.59	0.55		0.62	0.40	0.19		0.66	0.47	0.31	1.00	0.70	0.60	n/a
16 (406)	0.80	0.80	0.75	0.65		0.75	0.52	0.29	0.80	0.64	0.60	0.56		0.76	0.49	0.23		0.75	0.52	0.34		0.75	0.65	n/a
18 (457)	0.84	0.84	0.79	0.67		0.84	0.59	0.32	0.84	0.66	0.62	0.57		0.91	0.59	0.27		0.84	0.59	0.36		0.79	0.68	n/a
19-1/2 (495)	0.87	0.87	0.81	0.69		0.92	0.64	0.35	0.87	0.67	0.63	0.58		1.00	0.66	0.31		0.92	0.64	0.38		0.82	0.71	0.55
20 (508)	0.88	0.88	0.82	0.69		0.94	0.65	0.36	0.88	0.67	0.63	0.58			0.69	0.32		0.94	0.65	0.39		0.83	0.72	0.56
22 (559)	0.91	0.91	0.85	0.71		1.00	0.72	0.40	0.92	0.69	0.64	0.59			0.80	0.37		1.00	0.72	0.41		0.87	0.76	0.59
24 (610)	0.95	0.95	0.88	0.73			0.78	0.43	0.96	0.71	0.66	0.59			0.91	0.42			0.78	0.44		0.91	0.79	0.61
26 (660)	0.99	0.99	0.91	0.75			0.85	0.47	0.99	0.73	0.67	0.60			1.00	0.48			0.85	0.47		0.95	0.82	0.64
28 (711)	1.00	1.00	0.94	0.77			0.91	0.50	1.00	0.74	0.68	0.61				0.53			0.91	0.50		0.99	0.85	0.66
30 (762)			0.98	0.79			0.98	0.54		0.76	0.70	0.62				0.59			0.98	0.54		1.00	0.88	0.68
36 (914)			1.00	0.84			1.00	0.65		0.81	0.73	0.64				0.77			1.00	0.65			0.97	0.75
> 48 (1219)				0.96				0.86		0.92	0.81	0.69				1.00				0.86			1.00	0.87

Table 39 - Load adjustment factors for 7/8-in. diameter threaded rods in cracked concrete^{1,2,3}

7/8-in. cracked concrete	Spacing factor in tension f_{AN}				Edge distance factor in tension f_{RN}				Spacing factor in shear ⁴ f_{AV}				Edge distance in shear								Concrete thickness factor in shear ⁵ f_{HV}			
													⊥ Toward edge f_{RV}				∥ To and away from edge f_{RV}							
Embedment in. h_{ef} (mm)	3-1/2 (89)	7-7/8 (200)	10-1/2 (267)	17-1/2 (445)	3-1/2 (89)	7-7/8 (200)	10-1/2 (267)	17-1/2 (445)	3-1/2 (89)	7-7/8 (200)	10-1/2 (267)	17-1/2 (445)	3-1/2 (89)	7-7/8 (200)	10-1/2 (267)	17-1/2 (445)	3-1/2 (89)	7-7/8 (200)	10-1/2 (267)	17-1/2 (445)	3-1/2 (89)	7-7/8 (200)	10-1/2 (267)	17-1/2 (445)
1-3/4 (44)	n/a	n/a	n/a	n/a	0.42	0.42	0.41	0.38	n/a	n/a	n/a	n/a	0.09	0.03	0.02	0.01	0.18	0.06	0.04	0.02	n/a	n/a	n/a	n/a
4-3/8 (111)	0.58	0.58	0.57	0.54	0.53	0.53	0.50	0.44	0.58	0.54	0.53	0.52	0.36	0.11	0.07	0.03	0.71	0.22	0.14	0.07	n/a	n/a	n/a	n/a
5 (127)	0.59	0.59	0.58	0.55	0.56	0.56	0.52	0.45	0.60	0.54	0.53	0.52	0.43	0.13	0.09	0.04	0.87	0.27	0.17	0.08	n/a	n/a	n/a	n/a
5-1/2 (140)	0.60	0.60	0.59	0.55	0.58	0.58	0.54	0.46	0.61	0.55	0.54	0.52	0.50	0.15	0.10	0.05	1.00	0.31	0.20	0.10	0.65	n/a	n/a	n/a
6 (152)	0.61	0.61	0.60	0.56	0.61	0.61	0.56	0.47	0.61	0.55	0.54	0.52	0.57	0.18	0.11	0.06		0.35	0.23	0.11	0.68	n/a	n/a	n/a
7 (178)	0.63	0.63	0.61	0.57	0.65	0.65	0.60	0.49	0.63	0.56	0.55	0.53	0.72	0.22	0.14	0.07		0.44	0.29	0.14	0.73	n/a	n/a	n/a
8 (203)	0.65	0.65	0.63	0.58	0.71	0.71	0.64	0.52	0.65	0.57	0.55	0.53	0.88	0.27	0.18	0.09		0.54	0.35	0.17	0.78	n/a	n/a	n/a
9 (229)	0.67	0.67	0.64	0.59	0.76	0.76	0.68	0.54	0.67	0.58	0.56	0.54	1.00	0.32	0.21	0.10		0.65	0.42	0.20	0.83	n/a	n/a	n/a
9-7/8 (251)	0.69	0.69	0.66	0.59	0.80	0.80	0.72	0.56	0.69	0.59	0.56	0.54		0.37	0.24	0.12		0.74	0.48	0.23	0.87	0.59	n/a	n/a
10 (254)	0.69	0.69	0.66	0.60	0.81	0.81	0.73	0.56	0.69	0.59	0.57	0.54		0.38	0.25	0.12		0.76	0.49	0.24	0.87	0.59	n/a	n/a
11 (279)	0.71	0.71	0.67	0.60	0.87	0.87	0.77	0.59	0.71	0.60	0.57	0.54		0.44	0.28	0.14		0.87	0.57	0.28	0.92	0.62	n/a	n/a
12 (305)	0.73	0.73	0.69	0.61	0.92	0.92	0.82	0.61	0.73	0.60	0.58	0.55		0.50	0.32	0.16		1.00	0.65	0.31	0.96	0.65	n/a	n/a
12-1/2 (318)	0.74	0.74	0.70	0.62	0.95	0.95	0.84	0.62	0.74	0.61	0.58	0.55		0.53	0.34	0.17			0.69	0.33	0.98	0.66	0.57	n/a
14 (356)	0.76	0.76	0.72	0.63	1.00	1.00	0.91	0.66	0.77	0.62	0.59	0.56		0.63	0.41	0.20			0.82	0.40	1.00	0.70	0.61	n/a
16 (406)	0.80	0.80	0.75	0.65			1.00	0.71	0.81	0.64	0.60	0.56		0.77	0.50	0.24			1.00	0.48		0.75	0.65	n/a
18 (457)	0.84	0.84	0.79	0.67				0.76	0.84	0.66	0.62	0.57		0.91	0.59	0.29				0.58		0.79	0.69	n/a
19-1/2 (495)	0.87	0.87	0.81	0.69				0.80	0.87	0.67	0.63	0.58		1.00	0.67	0.32				0.65		0.82	0.71	0.56
20 (508)	0.88	0.88	0.82	0.69				0.82	0.88	0.67	0.63	0.58			0.70	0.34				0.67		0.84	0.72	0.57
22 (559)	0.91	0.91	0.85	0.71				0.87	0.92	0.69	0.64	0.59			0.80	0.39				0.78		0.88	0.76	0.60
24 (610)	0.95	0.95	0.88	0.73				0.93	0.96	0.71	0.66	0.60			0.91	0.44				0.89		0.92	0.79	0.62
26 (660)	0.99	0.99	0.91	0.75				0.99	1.00	0.73	0.67	0.61			1.00	0.50				0.99		0.95	0.82	0.65
28 (711)	1.00	1.00	0.94	0.77				1.00		0.74	0.68	0.61				0.56				1.00		0.99	0.86	0.67
30 (762)			0.98	0.79						0.76	0.70	0.62				0.62						1.00	0.89	0.70
36 (914)			1.00	0.84						0.81	0.74	0.65				0.81							0.97	0.76
> 48 (1219)				0.96						0.92	0.81	0.69				1.00							1.00	0.88

1 Linear interpolation not permitted.
 2 Shaded area with reduced edge distance is permitted provided the installation torque is reduced to 0.30 T_{max} for 5d ≤ s ≤ 16-in. and to 0.5 T_{max} for s > 16-in.
 3 When combining multiple load adjustment factors (e.g. for a 4 anchor pattern in a corner with a thin concrete member) the design can become very conservative. To optimize the design, use Hilti PROFIS Anchor Design software or perform anchor calculation using the design equations from ACI 318 Chapter 17.
 4 Spacing factor reduction in shear, f_{AV} , assumes an influence of a nearby edge. If no edge exists, then $f_{AV} = f_{AN}$.
 5 Concrete thickness reduction factor in shear, f_{HV} , assumes an influence of a nearby edge. If no edge exists, then $f_{HV} = 1.0$.

HIT-RE 500 V3 Epoxy Adhesive Anchoring System 3.2.4

Table 40 - Load adjustment factors for 1-in. diameter threaded rods in uncracked concrete^{1,2,3}

Embedment h_{ef} in. (mm)	Spacing factor in tension f_{AN}				Edge distance factor in tension f_{RN}				Spacing factor in shear ⁴ f_{AV}				Edge distance in shear								Concrete thickness factor in shear ⁵ f_{HV}			
													⊥ Toward edge f_{RV}				To and away from edge f_{RV}							
		4 (102)	9 (229)	12 (305)	20 (508)	4 (102)	9 (229)	12 (305)	20 (508)	4 (102)	9 (229)	12 (305)	20 (508)	4 (102)	9 (229)	12 (305)	20 (508)	4 (102)	9 (229)	12 (305)	20 (508)	4 (102)	9 (229)	12 (305)
1-3/4 (44)	n/a	n/a	n/a	n/a	0.38	0.24	0.18	0.10	n/a	n/a	n/a	n/a	0.08	0.02	0.01	0.01	0.15	0.05	0.03	0.01	n/a	n/a	n/a	n/a
5 (127)	0.58	0.58	0.57	0.54	0.53	0.32	0.23	0.13	0.59	0.54	0.53	0.52	0.37	0.11	0.07	0.03	0.65	0.22	0.14	0.07	n/a	n/a	n/a	n/a
6 (152)	0.60	0.60	0.58	0.55	0.58	0.34	0.25	0.14	0.60	0.55	0.53	0.52	0.48	0.14	0.09	0.04	0.74	0.29	0.19	0.09	n/a	n/a	n/a	n/a
6-1/4 (159)	0.60	0.60	0.59	0.55	0.59	0.35	0.26	0.14	0.61	0.55	0.54	0.52	0.51	0.15	0.10	0.05	0.77	0.30	0.20	0.09	0.65	n/a	n/a	n/a
7 (178)	0.62	0.62	0.60	0.56	0.62	0.37	0.27	0.15	0.62	0.55	0.54	0.52	0.61	0.18	0.12	0.05	0.87	0.36	0.23	0.11	0.69	n/a	n/a	n/a
8 (203)	0.63	0.63	0.61	0.57	0.66	0.40	0.29	0.16	0.64	0.56	0.55	0.53	0.74	0.22	0.14	0.07	0.99	0.40	0.29	0.13	0.74	n/a	n/a	n/a
9 (229)	0.65	0.65	0.63	0.58	0.71	0.43	0.31	0.17	0.65	0.57	0.55	0.53	0.89	0.26	0.17	0.08	1.00	0.43	0.34	0.16	0.78	n/a	n/a	n/a
10 (254)	0.67	0.67	0.64	0.58	0.75	0.46	0.33	0.18	0.67	0.58	0.56	0.53	1.00	0.31	0.20	0.09	0.46	0.35	0.19	0.83	n/a	n/a	n/a	n/a
11 (279)	0.68	0.68	0.65	0.59	0.80	0.49	0.35	0.19	0.69	0.58	0.56	0.54	0.35	0.23	0.11	0.49	0.37	0.21	0.87	n/a	n/a	n/a	n/a	
11-1/4 (286)	0.69	0.69	0.66	0.59	0.81	0.50	0.35	0.19	0.69	0.59	0.56	0.54	0.37	0.24	0.11	0.50	0.38	0.22	0.88	0.58	n/a	n/a	n/a	
12 (305)	0.70	0.70	0.67	0.60	0.85	0.52	0.37	0.20	0.70	0.59	0.57	0.54	0.40	0.26	0.12	0.52	0.39	0.24	0.91	0.60	n/a	n/a	n/a	
13 (330)	0.72	0.72	0.68	0.61	0.90	0.55	0.39	0.21	0.72	0.60	0.57	0.54	0.46	0.30	0.14	0.55	0.42	0.28	0.94	0.63	n/a	n/a	n/a	
14 (356)	0.73	0.73	0.69	0.62	0.95	0.59	0.41	0.23	0.74	0.61	0.58	0.55	0.51	0.33	0.15	0.59	0.44	0.30	0.98	0.65	n/a	n/a	n/a	
14-1/4 (362)	0.74	0.74	0.70	0.62	0.97	0.60	0.42	0.23	0.74	0.61	0.58	0.55	0.52	0.34	0.16	0.60	0.44	0.30	0.99	0.66	0.57	n/a	n/a	
16 (406)	0.77	0.77	0.72	0.63	1.00	0.67	0.47	0.26	0.77	0.62	0.59	0.55	0.62	0.40	0.19	0.67	0.48	0.32	1.00	0.70	0.60	n/a	n/a	
18 (457)	0.80	0.80	0.75	0.65	0.76	0.53	0.29	0.81	0.64	0.60	0.56	0.56	0.74	0.48	0.22	0.76	0.53	0.34	0.74	0.64	n/a	n/a		
20 (508)	0.84	0.84	0.78	0.67	0.84	0.58	0.32	0.84	0.65	0.61	0.57	0.57	0.87	0.56	0.26	0.84	0.58	0.36	0.78	0.67	n/a	n/a		
22 (559)	0.87	0.87	0.81	0.68	0.93	0.64	0.35	0.88	0.67	0.63	0.58	0.58	1.00	0.65	0.30	0.93	0.64	0.38	0.82	0.71	n/a	n/a		
22-1/4 (565)	0.87	0.87	0.81	0.69	0.94	0.65	0.36	0.88	0.67	0.63	0.58	0.58	0.66	0.31	0.14	0.94	0.65	0.39	0.82	0.71	0.55	0.55		
24 (610)	0.90	0.90	0.83	0.70	1.00	0.70	0.38	0.91	0.68	0.64	0.58	0.58	0.74	0.35	0.15	1.00	0.70	0.41	0.85	0.74	0.57	0.57		
26 (660)	0.94	0.94	0.86	0.72	0.76	0.42	0.94	0.70	0.65	0.59	0.59	0.59	0.84	0.39	0.17	0.76	0.43	0.89	0.77	0.60	0.60			
28 (711)	0.97	0.97	0.89	0.73	0.82	0.45	0.98	0.71	0.66	0.60	0.60	0.60	0.94	0.43	0.19	0.82	0.45	0.92	0.80	0.62	0.62			
30 (762)	1.00	1.00	0.92	0.75	0.88	0.48	1.00	0.73	0.67	0.60	0.60	0.60	1.00	0.48	0.21	0.88	0.48	0.95	0.83	0.64	0.64			
36 (914)			1.00	0.80	1.00	0.58	0.77	0.70	0.62	0.62	0.62	0.62				0.63	1.00	0.58	1.00	0.91	0.70	0.70		
> 48 (1219)				0.90			0.77		0.86	0.77	0.66	0.66				0.98			1.00	0.81	0.81	0.81		

3.2.4

Table 41 - Load adjustment factors for 1-in. diameter threaded rods in cracked concrete^{1,2,3}

Embedment h_{ef} in. (mm)	Spacing factor in tension f_{AN}				Edge distance factor in tension f_{RN}				Spacing factor in shear ⁴ f_{AV}				Edge distance in shear								Concrete thickness factor in shear ⁵ f_{HV}			
													⊥ Toward edge f_{RV}				To and away from edge f_{RV}							
		4 (102)	9 (229)	12 (305)	20 (508)	4 (102)	9 (229)	12 (305)	20 (508)	4 (102)	9 (229)	12 (305)	20 (508)	4 (102)	9 (229)	12 (305)	20 (508)	4 (102)	9 (229)	12 (305)	20 (508)	4 (102)	9 (229)	12 (305)
1-3/4 (44)	n/a	n/a	n/a	n/a	0.41	0.41	0.40	0.38	n/a	n/a	n/a	n/a	0.08	0.02	0.01	0.01	0.15	0.05	0.03	0.01	n/a	n/a	n/a	n/a
5 (127)	0.58	0.58	0.57	0.54	0.53	0.53	0.50	0.44	0.59	0.54	0.53	0.52	0.37	0.11	0.07	0.03	0.74	0.22	0.14	0.07	n/a	n/a	n/a	n/a
6 (152)	0.60	0.60	0.58	0.55	0.58	0.58	0.53	0.46	0.60	0.55	0.53	0.52	0.49	0.14	0.09	0.04	0.97	0.29	0.19	0.09	n/a	n/a	n/a	n/a
6-1/4 (159)	0.60	0.60	0.59	0.55	0.59	0.59	0.54	0.46	0.61	0.55	0.54	0.52	0.52	0.15	0.10	0.05	1.00	0.31	0.20	0.09	0.66	n/a	n/a	n/a
7 (178)	0.62	0.62	0.60	0.56	0.62	0.62	0.57	0.47	0.62	0.55	0.54	0.52	0.61	0.18	0.12	0.05	0.36	0.24	0.11	0.69	n/a	n/a	n/a	n/a
8 (203)	0.63	0.63	0.61	0.57	0.66	0.66	0.60	0.49	0.64	0.56	0.55	0.53	0.75	0.22	0.14	0.07	0.44	0.29	0.13	0.74	n/a	n/a	n/a	n/a
9 (229)	0.65	0.65	0.63	0.58	0.71	0.71	0.64	0.51	0.65	0.57	0.55	0.53	0.89	0.26	0.17	0.08	0.53	0.34	0.16	0.79	n/a	n/a	n/a	n/a
10 (254)	0.67	0.67	0.64	0.58	0.75	0.75	0.67	0.53	0.67	0.58	0.56	0.53	1.00	0.31	0.20	0.09	0.62	0.40	0.19	0.83	n/a	n/a	n/a	n/a
11 (279)	0.68	0.68	0.65	0.59	0.80	0.80	0.71	0.55	0.69	0.58	0.56	0.54	0.36	0.23	0.11	0.72	0.46	0.22	0.87	n/a	n/a	n/a	n/a	
11-1/4 (286)	0.69	0.69	0.66	0.59	0.81	0.81	0.72	0.56	0.69	0.59	0.56	0.54	0.37	0.24	0.11	0.74	0.48	0.22	0.88	0.59	n/a	n/a	n/a	
12 (305)	0.70	0.70	0.67	0.60	0.85	0.85	0.75	0.57	0.71	0.59	0.57	0.54	0.41	0.26	0.12	0.82	0.53	0.25	0.91	0.61	n/a	n/a	n/a	
13 (330)	0.72	0.72	0.68	0.61	0.90	0.90	0.79	0.59	0.72	0.60	0.57	0.54	0.46	0.30	0.14	0.92	0.60	0.28	0.95	0.63	n/a	n/a	n/a	
14 (356)	0.73	0.73	0.69	0.62	0.95	0.95	0.83	0.62	0.74	0.61	0.58	0.55	0.51	0.33	0.16	1.00	0.67	0.31	0.98	0.65	n/a	n/a	n/a	
14-1/4 (362)	0.74	0.74	0.70	0.62	0.97	0.97	0.84	0.62	0.74	0.61	0.58	0.55	0.53	0.34	0.16	0.69	0.32	0.99	0.66	0.57	n/a	n/a	n/a	
16 (406)	0.77	0.77	0.72	0.63	1.00	1.00	0.91	0.66	0.77	0.62	0.59	0.55	0.63	0.41	0.19	0.82	0.38	1.00	0.70	0.61	n/a	n/a	n/a	
18 (457)	0.80	0.80	0.75	0.65	1.00	0.70	0.81	0.64	0.60	0.56	0.56	0.56	0.75	0.49	0.23	0.97	0.45	0.74	0.64	n/a	n/a			
20 (508)	0.84	0.84	0.78	0.67	0.75	0.84	0.65	0.61	0.57	0.57	0.57	0.57	0.88	0.57	0.26	1.00	0.53	0.78	0.68	n/a	n/a			
22 (559)	0.87	0.87	0.81	0.68	0.80	0.88	0.67	0.63	0.58	0.58	0.58	0.58	1.00	0.66	0.31	0.61	0.61	0.82	0.71	n/a	n/a			
22-1/4 (565)	0.87	0.87	0.81	0.69	0.80	0.88	0.67	0.63	0.58	0.58	0.58	0.58	0.67	0.31	0.14	0.62	0.62	0.82	0.71	0.55	0.55			
24 (610)	0.90	0.90	0.83	0.70	0.85	0.91	0.68	0.64	0.58	0.58	0.58	0.58	0.75	0.35	0.15	0.70	0.70	0.86	0.74	0.57	0.57			
26 (660)	0.94	0.94	0.86	0.72	0.90	0.95	0.70	0.65	0.59	0.59	0.59	0.59	0.84	0.39	0.17	0.78	0.78	0.89	0.77	0.60	0.60			
28 (711)	0.97	0.97	0.89	0.73	0.95	0.98	0.71	0.66	0.60	0.60	0.60	0.60	0.94	0.44	0.21	0.88	0.88	0.92	0.80	0.62	0.62			
30 (762)	1.00	1.00	0.92	0.75	1.00	1.00	0.73	0.67	0.60	0.60	0.60	0.60	1.00	0.49	0.21	0.97	0.97	0.96	0.83	0.64	0.64			
36 (914)			1.00	0.80	1.00	0.77	0.71	0.62	0.62	0.62	0.62	0.62				0.64	1.00	1.00	0.91	0.70	0.70			
> 48 (

3.2.4 HIT-RE 500 V3 Epoxy Adhesive Anchoring System

Table 42 - Load adjustment factors for 1-1/4-in. diameter threaded rods in uncracked concrete^{1,2,3}

1-1/4-in. uncracked concrete	Spacing factor in tension f_{AN}				Edge distance factor in tension f_{RN}				Spacing factor in shear ⁴ f_{AV}				Edge distance in shear											
													⊥ Toward edge f_{RV}				∥ To and away from edge f_{RV}				Concrete thickness factor in shear ⁵ f_{HV}			
Embedment in. h_{ef} (mm)	5 (127)	11-1/4 (286)	15 (381)	25 (635)	5 (127)	11-1/4 (286)	15 (381)	25 (635)	5 (127)	11-1/4 (286)	15 (381)	25 (635)	5 (127)	11-1/4 (286)	15 (381)	25 (635)	5 (127)	11-1/4 (286)	15 (381)	25 (635)	5 (127)	11-1/4 (286)	15 (381)	25 (635)
1-3/4 (44)	n/a	n/a	n/a	n/a	0.37	0.24	0.17	0.09	n/a	n/a	n/a	n/a	0.05	0.02	0.01	0.00	0.11	0.03	0.02	0.01	n/a	n/a	n/a	n/a
6-1/4 (159)	0.59	0.59	0.57	0.54	0.54	0.33	0.24	0.13	0.59	0.54	0.53	0.52	0.37	0.11	0.07	0.03	0.67	0.22	0.14	0.07	n/a	n/a	n/a	n/a
7 (178)	0.60	0.60	0.58	0.55	0.57	0.35	0.25	0.13	0.60	0.54	0.53	0.52	0.43	0.13	0.08	0.04	0.73	0.26	0.17	0.08	n/a	n/a	n/a	n/a
8 (203)	0.61	0.61	0.59	0.55	0.61	0.37	0.26	0.14	0.61	0.55	0.54	0.52	0.53	0.16	0.10	0.05	0.82	0.31	0.20	0.10	0.66	n/a	n/a	n/a
9 (229)	0.63	0.63	0.60	0.56	0.64	0.39	0.28	0.15	0.62	0.55	0.54	0.52	0.63	0.19	0.12	0.06	0.93	0.38	0.24	0.11	0.70	n/a	n/a	n/a
10 (254)	0.64	0.64	0.61	0.57	0.68	0.41	0.29	0.16	0.64	0.56	0.55	0.53	0.74	0.22	0.14	0.07	1.00	0.41	0.29	0.13	0.74	n/a	n/a	n/a
11 (279)	0.65	0.65	0.62	0.57	0.72	0.44	0.31	0.17	0.65	0.57	0.55	0.53	0.86	0.25	0.16	0.08		0.44	0.33	0.15	0.78	n/a	n/a	n/a
12 (305)	0.67	0.67	0.63	0.58	0.76	0.46	0.33	0.18	0.66	0.57	0.55	0.53	0.98	0.29	0.19	0.09		0.46	0.36	0.17	0.81	n/a	n/a	n/a
13 (330)	0.68	0.68	0.64	0.59	0.80	0.49	0.35	0.19	0.68	0.58	0.56	0.54	1.00	0.33	0.21	0.10		0.49	0.38	0.20	0.84	n/a	n/a	n/a
14 (356)	0.70	0.70	0.66	0.59	0.84	0.52	0.36	0.20	0.69	0.59	0.56	0.54		0.36	0.24	0.11		0.52	0.40	0.22	0.87	0.58	n/a	n/a
14-1/4 (362)	0.70	0.70	0.66	0.60	0.85	0.52	0.37	0.20	0.69	0.59	0.56	0.54		0.37	0.24	0.11		0.52	0.40	0.23	0.88	0.59	n/a	n/a
15 (381)	0.71	0.71	0.67	0.60	0.88	0.54	0.38	0.21	0.70	0.59	0.57	0.54		0.40	0.26	0.12		0.54	0.41	0.24	0.91	0.60	n/a	n/a
16 (406)	0.72	0.72	0.68	0.61	0.92	0.57	0.40	0.22	0.72	0.60	0.57	0.54		0.45	0.29	0.13		0.57	0.43	0.27	0.94	0.62	n/a	n/a
17 (432)	0.74	0.74	0.69	0.61	0.96	0.60	0.42	0.23	0.73	0.60	0.58	0.55		0.49	0.32	0.15		0.60	0.45	0.29	0.96	0.64	n/a	n/a
18 (457)	0.75	0.75	0.70	0.62	1.00	0.63	0.44	0.24	0.75	0.61	0.58	0.55		0.53	0.35	0.16		0.63	0.47	0.31	0.99	0.66	0.57	n/a
20 (508)	0.78	0.78	0.72	0.63		0.70	0.49	0.27	0.77	0.62	0.59	0.55		0.62	0.40	0.19		0.70	0.50	0.33	1.00	0.70	0.60	n/a
22 (559)	0.81	0.81	0.74	0.65		0.77	0.54	0.29	0.80	0.63	0.60	0.56		0.72	0.47	0.22		0.77	0.54	0.35		0.73	0.63	n/a
24 (610)	0.84	0.84	0.77	0.66		0.84	0.59	0.32	0.83	0.65	0.61	0.57		0.82	0.53	0.25		0.84	0.59	0.36		0.76	0.66	n/a
26 (660)	0.87	0.87	0.79	0.67		0.91	0.64	0.34	0.86	0.66	0.62	0.57		0.92	0.60	0.28		0.91	0.64	0.38		0.79	0.69	n/a
28 (711)	0.89	0.89	0.81	0.69		0.98	0.68	0.37	0.88	0.67	0.63	0.58		1.00	0.67	0.31		0.98	0.68	0.40		0.82	0.71	0.55
30 (762)	0.92	0.92	0.83	0.70		1.00	0.73	0.40	0.91	0.68	0.64	0.58			0.74	0.35		1.00	0.73	0.42		0.85	0.74	0.57
36 (914)	1.00	1.00	0.90	0.74			0.88	0.48	0.99	0.72	0.66	0.60			0.98	0.45			0.88	0.48		0.94	0.81	0.63
> 48 (1219)			1.00	0.82			1.00	0.64	1.00	0.79	0.72	0.63			1.00	0.70			1.00	0.64		1.00	0.94	0.72

Table 43 - Load adjustment factors for 1-1/4-in. diameter threaded rods in cracked concrete^{1,2,3}











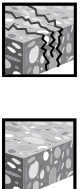

1-1/4-in. cracked concrete	Spacing factor in tension f_{AN}				Edge distance factor in tension f_{RN}				Spacing factor in shear ⁴ f_{AV}				Edge distance in shear											
													⊥ Toward edge f_{RV}				∥ To and away from edge f_{RV}				Concrete thickness factor in shear ⁵ f_{HV}			
Embedment in. h_{ef} (mm)	5 (127)	11-1/4 (286)	15 (381)	25 (635)	5 (127)	11-1/4 (286)	15 (381)	25 (635)	5 (127)	11-1/4 (286)	15 (381)	25 (635)	5 (127)	11-1/4 (286)	15 (381)	25 (635)	5 (127)	11-1/4 (286)	15 (381)	25 (635)	5 (127)	11-1/4 (286)	15 (381)	25 (635)
1-3/4 (44)	n/a	n/a	n/a	n/a	0.40	0.40	0.39	0.37	n/a	n/a	n/a	n/a	0.05	0.02	0.01	0.00	0.11	0.03	0.02	0.01	n/a	n/a	n/a	n/a
6-1/4 (159)	0.59	0.59	0.57	0.54	0.54	0.54	0.50	0.44	0.59	0.54	0.53	0.52	0.37	0.11	0.07	0.03	0.74	0.22	0.14	0.07	n/a	n/a	n/a	n/a
7 (178)	0.60	0.60	0.58	0.55	0.57	0.57	0.52	0.45	0.60	0.54	0.53	0.52	0.44	0.13	0.08	0.04	0.88	0.26	0.17	0.08	n/a	n/a	n/a	n/a
8 (203)	0.61	0.61	0.59	0.55	0.61	0.61	0.55	0.46	0.61	0.55	0.54	0.52	0.54	0.16	0.10	0.05	1.00	0.32	0.21	0.10	0.66	n/a	n/a	n/a
9 (229)	0.63	0.63	0.60	0.56	0.64	0.64	0.57	0.48	0.62	0.55	0.54	0.52	0.64	0.19	0.12	0.06		0.38	0.25	0.11	0.70	n/a	n/a	n/a
10 (254)	0.64	0.64	0.61	0.57	0.68	0.68	0.60	0.49	0.64	0.56	0.55	0.53	0.75	0.22	0.14	0.07		0.44	0.29	0.13	0.74	n/a	n/a	n/a
11 (279)	0.65	0.65	0.62	0.57	0.72	0.72	0.63	0.51	0.65	0.57	0.55	0.53	0.86	0.26	0.17	0.08		0.51	0.33	0.15	0.78	n/a	n/a	n/a
12 (305)	0.67	0.67	0.63	0.58	0.76	0.76	0.66	0.53	0.66	0.57	0.55	0.53	0.98	0.29	0.19	0.09		0.58	0.38	0.18	0.81	n/a	n/a	n/a
13 (330)	0.68	0.68	0.64	0.59	0.80	0.80	0.69	0.54	0.68	0.58	0.56	0.54	1.00	0.33	0.21	0.10		0.66	0.43	0.20	0.85	n/a	n/a	n/a
14 (356)	0.70	0.70	0.66	0.59	0.84	0.84	0.72	0.56	0.69	0.59	0.56	0.54		0.37	0.24	0.11		0.73	0.48	0.22	0.88	0.58	n/a	n/a
14-1/4 (362)	0.70	0.70	0.66	0.60	0.85	0.85	0.73	0.56	0.70	0.59	0.57	0.54		0.38	0.25	0.11		0.75	0.49	0.23	0.89	0.59	n/a	n/a
15 (381)	0.71	0.71	0.67	0.60	0.88	0.88	0.75	0.57	0.71	0.59	0.57	0.54		0.41	0.26	0.12		0.82	0.53	0.25	0.91	0.61	n/a	n/a
16 (406)	0.72	0.72	0.68	0.61	0.92	0.92	0.78	0.59	0.72	0.60	0.57	0.54		0.45	0.29	0.14		0.90	0.58	0.27	0.94	0.63	n/a	n/a
17 (432)	0.74	0.74	0.69	0.61	0.96	0.96	0.81	0.61	0.73	0.60	0.58	0.55		0.49	0.32	0.15		0.98	0.64	0.30	0.97	0.64	n/a	n/a
18 (457)	0.75	0.75	0.70	0.62	1.00	1.00	0.85	0.62	0.75	0.61	0.58	0.55		0.54	0.35	0.16		1.00	0.70	0.32	0.99	0.66	0.57	n/a
20 (508)	0.78	0.78	0.72	0.63			0.91	0.66	0.77	0.62	0.59	0.55		0.63	0.41	0.19			0.82	0.38	1.00	0.70	0.61	n/a
22 (559)	0.81	0.81	0.74	0.65			0.98	0.69	0.80	0.63	0.60	0.56		0.72	0.47	0.22			0.94	0.44		0.73	0.63	n/a
24 (610)	0.84	0.84	0.77	0.66			1.00	0.73	0.83	0.65	0.61	0.57		0.82	0.54	0.25			1.00	0.50		0.77	0.66	n/a
26 (660)	0.87	0.87	0.79	0.67				0.77	0.86	0.66	0.62	0.57		0.93	0.60	0.28				0.56		0.80	0.69	n/a
28 (711)	0.89	0.89	0.81	0.69				0.81	0.88	0.67	0.63	0.58		1.00	0.68	0.31				0.63		0.83	0.72	0.55
30 (762)	0.92	0.92	0.83	0.70				0.85	0.91	0.68	0.64	0.58			0.75	0.35				0.70		0.86	0.74	0.57
36 (914)	1.00	1.00	0.90	0.74				0.97	0.99	0.72	0.66	0.60			0.98	0.46				0.91		0.94	0.81	0.63
> 48 (1219)			1.00	0.82				1.00	1.00	0.79	0.72	0.63			1.00	0.70				1.00		1.00	0.94	0.73</

HIT-RE 500 V3 Epoxy Adhesive Anchoring System 3.2.4

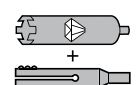
3.2.4.3.6 HIT-RE 500 V3 adhesive with HIS-N and HIS-RN internally threaded insert



Figure 7 - Hilti HIS-N and HIS-RN internally threaded insert installation conditions

Cracked or uncracked concrete	Permissible drilling methods	Permissible concrete conditions
 <p>Cracked and uncracked concrete</p>	 <p>Hammer drilling with carbide-tipped drill bit</p>	 Dry concrete  Water-saturated concrete  Water-filled holes  Submerged (underwater)
	  <p>Hilti TE-CD or TE-YD hollow drill bit Diamond core drill bit with Hilti TE-YRT roughening tool</p>	 Dry concrete  Water-saturated concrete
 <p>Uncracked concrete</p>	 <p>Diamond core drill bit</p>	 Dry concrete  Water-saturated concrete

3.2.4

Table 44 - HIS-N and HIS-RN specifications

Setting information	Symbol	Units	Thread size			
			3/8-16 UNC	1/2-13 UNC	5/8-11 UNC	3/4-10 UNC
Outside diameter of insert		in.	0.65	0.81	1.00	1.09
Nominal bit diameter	d_o	in.	11/16	7/8	1-1/8	1-1/4
Effective embedment	h_{ef}	in. (mm)	4-3/8 (110)	5 (125)	6-3/4 (170)	8-1/8 (205)
Thread engagement	minimum h_s maximum	in.	3/8	1/2	5/8	3/4
		in.	15/16	1-3/16	1-1/2	1-7/8
Installation torque	T_{inst}	ft-lb (Nm)	15 (20)	30 (40)	60 (81)	100 (136)
Minimum concrete thickness	h_{min}	in. (mm)	5.9 (150)	6.7 (170)	9.1 (230)	10.6 (270)
Minimum edge distance	c_{min}	in (mm)	3-1/4 (83)	4 (102)	5 (127)	5-1/2 (140)
Minimum anchor spacing	s_{min}	in (mm)	3-1/4 (83)	4 (102)	5 (127)	5-1/2 (140)

Figure 8 - Hilti HIS-N and HIS-RN specifications

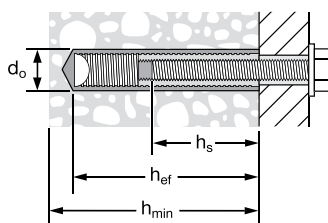

3.2.4 HIT-RE 500 V3 Epoxy Adhesive Anchoring System

Table 45 - Hilti HIT-RE 500 V3 adhesive design strength with concrete / bond failure for Hilti HIS-N and HIS-RN internally threaded inserts in uncracked concrete^{1,2,3,4,5,6,7,8,9,11}

Thread size	Effective embedment in. (mm)	Tension — ΦN_n				Shear — ΦV_n			
		$f'_c = 2,500$ psi (17.2 MPa) lb (kN)	$f'_c = 3,000$ psi (20.7 MPa) lb (kN)	$f'_c = 4,000$ psi (27.6 MPa) lb (kN)	$f'_c = 6,000$ psi (41.4 MPa) lb (kN)	$f'_c = 2,500$ psi (17.2 MPa) lb (kN)	$f'_c = 3,000$ psi (20.7 MPa) lb (kN)	$f'_c = 4,000$ psi (27.6 MPa) lb (kN)	$f'_c = 6,000$ psi (41.4 MPa) lb (kN)
3/8-16 UNC	4-3/8 (111)	7,140 (31.8)	7,820 (34.8)	9,030 (40.2)	11,060 (49.2)	15,375 (68.4)	16,840 (74.9)	19,445 (86.5)	23,815 (105.9)
1/2-13 ¹⁰ UNC	5 (127)	8,720 (38.8)	9,555 (42.5)	11,030 (49.1)	13,510 (60.1)	18,785 (83.6)	20,575 (91.5)	23,760 (105.7)	29,100 (129.4)
5/8-11 ¹⁰ UNC	6-3/4 (171)	13,680 (60.9)	14,985 (66.7)	17,305 (77.0)	21,190 (94.3)	29,460 (131.0)	32,275 (143.6)	37,265 (165.8)	45,645 (203.0)
3/4-10 ¹⁰ UNC	8-1/8 (206)	18,065 (80.4)	19,790 (88.0)	22,850 (101.6)	27,985 (124.5)	38,910 (173.1)	42,620 (189.6)	49,215 (218.9)	60,275 (268.1)

Table 46 - Hilti HIT-RE 500 V3 adhesive design strength with concrete / bond failure for Hilti HIS-N and HIS-RN internally threaded inserts in cracked concrete^{1,2,3,4,5,6,7,8,9,11}

Thread size	Effective embedment in. (mm)	Tension — ΦN_n				Shear — ΦV_n			
		$f'_c = 2,500$ psi (17.2 MPa) lb (kN)	$f'_c = 3,000$ psi (20.7 MPa) lb (kN)	$f'_c = 4,000$ psi (27.6 MPa) lb (kN)	$f'_c = 6,000$ psi (41.4 MPa) lb (kN)	$f'_c = 2,500$ psi (17.2 MPa) lb (kN)	$f'_c = 3,000$ psi (20.7 MPa) lb (kN)	$f'_c = 4,000$ psi (27.6 MPa) lb (kN)	$f'_c = 6,000$ psi (41.4 MPa) lb (kN)
3/8-16 UNC	4-3/8 (111)	5,055 (22.5)	5,540 (24.6)	6,395 (28.4)	7,085 (31.5)	10,890 (48.4)	11,930 (53.1)	13,775 (61.3)	15,260 (67.9)
1/2-13 ¹⁰ UNC	5 (127)	6,175 (27.5)	6,765 (30.1)	7,815 (34.8)	9,570 (42.6)	13,305 (59.2)	14,575 (64.8)	16,830 (74.9)	20,610 (91.7)
5/8-11 ¹⁰ UNC	6-3/4 (171)	9,690 (43.1)	10,615 (47.2)	12,255 (54.5)	15,010 (66.8)	20,870 (92.8)	22,860 (101.7)	26,395 (117.4)	32,330 (143.8)
3/4-10 ¹⁰ UNC	8-1/8 (206)	12,795 (56.9)	14,015 (62.3)	16,185 (72.0)	19,825 (88.2)	27,560 (122.6)	30,190 (134.3)	34,860 (155.1)	42,695 (189.9)

- See Section 3.1.8 for explanation on development of load values.
- See Section 3.1.8.6 to convert design strength (factored resistance) value to ASD value.
- Linear interpolation between embedment depths and concrete compressive strengths is not permitted.
- Apply spacing, edge distance, and concrete thickness factors in tables 50 and 51 as necessary to the above values. Compare to the steel values in table 49. The lesser of the values is to be used for the design.
- Data is for temperature range A: Max. short term temperature = 130° F (55° C), max. long term temperature = 110° F (43° C).
For temperature range B: Max. short term temperature = 176° F (80° C), max. long term temperature = 110° F (43° C) multiply above values by 0.69
Short term elevated concrete temperatures are those that occur over brief intervals, e.g., as a result of diurnal cycling. Long term concrete temperatures are roughly constant over significant periods of time.
- Tabular values are for dry concrete and water saturated concrete conditions.
For water-filled drilled holes multiply design strength by 0.52.
For submerged (under water) applications multiply design strength by 0.46.
- Tabular values are for short term loads only. For sustained loads including overhead use, see Section 3.1.8.8.
- Tabular values are for normal-weight concrete only. For lightweight concrete multiply design strength by λ_a as follows:
For sand-lightweight, $\lambda_a = 0.51$. For all-lightweight, $\lambda_a = 0.45$.
- Tabular values are for holes drilled in concrete with carbide tipped hammer drill bit. Diamond core drilling is not permitted in cracked concrete except as indicated in note 10. For diamond core drilling in uncracked concrete, except as indicated in note 10, multiply the above values by 0.57. Diamond core drilling is not permitted for water-filled or under-water (submerged) applications in uncracked concrete.
- Diamond core drilling is permitted in uncracked and cracked concrete with use of the Hilti TE-YRT roughening tool for 1/2-13 UNC, 5/8-11 UNC, and 3/4-10 UNC anchors in dry and water-saturated concrete. See Tables 47 and 48.
- Tabular values are for static loads only. Seismic design is not permitted for uncracked concrete. For seismic loads, multiply cracked concrete tabular values in tension and shear by $\alpha_{seis} = 0.75$. See section 3.1.8.7 for additional information on seismic applications.

HIT-RE 500 V3 Epoxy Adhesive Anchoring System 3.2.4

Table 47 - Hilti HIT-RE 500 V3 in Core Drilled Holes roughened with TE-YRT Roughening Tool adhesive design strength with concrete / bond failure for Hilti HIS-N and HIS-RN internally threaded inserts in uncracked concrete^{1,2,3,4,5,6,7,8}

Thread size	Effective embedment in. (mm)	Tension — ΦN_n				Shear — ΦV_n			
		$f'_c = 2,500$ psi (17.2 MPa) lb (kN)	$f'_c = 3,000$ psi (20.7 MPa) lb (kN)	$f'_c = 4,000$ psi (27.6 MPa) lb (kN)	$f'_c = 6,000$ psi (41.4 MPa) lb (kN)	$f'_c = 2,500$ psi (17.2 MPa) lb (kN)	$f'_c = 3,000$ psi (20.7 MPa) lb (kN)	$f'_c = 4,000$ psi (27.6 MPa) lb (kN)	$f'_c = 6,000$ psi (41.4 MPa) lb (kN)
1/2-13 UNC	5 (127)	8,720 (38.8)	9,555 (42.5)	11,030 (49.1)	13,510 (60.1)	18,785 (83.6)	20,575 (91.5)	23,760 (105.7)	29,100 (129.4)
5/8-11 UNC	6-3/4 (171)	13,680 (60.9)	14,985 (66.7)	17,305 (77.0)	21,190 (94.3)	29,460 (131.0)	32,275 (143.6)	37,265 (165.8)	45,645 (203.0)
3/4-10 UNC	8-1/8 (206)	18,065 (80.4)	19,790 (88.0)	22,850 (101.6)	27,985 (124.5)	38,910 (173.1)	42,620 (189.6)	49,215 (218.9)	60,275 (268.1)

Table 48 - Hilti HIT-RE 500 V3 in Core Drilled Holes roughened with TE-YRT Roughening Tool adhesive design strength with concrete / bond failure for Hilti HIS-N and HIS-RN internally threaded inserts in cracked concrete^{1,2,3,4,5,6,7,8,9}

Thread size	Effective embedment in. (mm)	Tension — ΦN_n				Shear — ΦV_n			
		$f'_c = 2,500$ psi (17.2 MPa) lb (kN)	$f'_c = 3,000$ psi (20.7 MPa) lb (kN)	$f'_c = 4,000$ psi (27.6 MPa) lb (kN)	$f'_c = 6,000$ psi (41.4 MPa) lb (kN)	$f'_c = 2,500$ psi (17.2 MPa) lb (kN)	$f'_c = 3,000$ psi (20.7 MPa) lb (kN)	$f'_c = 4,000$ psi (27.6 MPa) lb (kN)	$f'_c = 6,000$ psi (41.4 MPa) lb (kN)
1/2-13 UNC	5 (127)	6,175 (27.5)	6,205 (27.6)	6,205 (27.6)	6,205 (27.6)	13,305 (59.2)	13,360 (59.4)	13,360 (59.4)	13,360 (59.4)
5/8-11 UNC	6-3/4 (171)	9,690 (43.1)	10,340 (46.0)	10,340 (46.0)	10,340 (46.0)	20,870 (92.8)	22,265 (99.0)	22,265 (99.0)	22,265 (99.0)
3/4-10 UNC	8-1/8 (206)	12,795 (56.9)	13,565 (60.3)	13,565 (60.3)	13,565 (60.3)	27,560 (122.6)	29,215 (130.0)	29,215 (130.0)	29,215 (130.0)

- See Section 3.1.8 for explanation on development of load values.
- See Section 3.1.8.6 to convert design strength (factored resistance) value to ASD value.
- Linear interpolation between embedment depths and concrete compressive strengths is not permitted.
- Apply spacing, edge distance, and concrete thickness factors in tables 50 and 51 as necessary to the above values. Compare to the steel values in table 49. The lesser of the values is to be used for the design.
- Data is for temperature range A: Max. short term temperature = 130° F (55° C), max. long term temperature = 110° F (43° C). For temperature range B: Max. short term temperature = 176° F (80° C), max. long term temperature = 110° F (43° C) multiply above values by 0.69. Short term elevated concrete temperatures are those that occur over brief intervals, e.g., as a result of diurnal cycling. Long term concrete temperatures are roughly constant over significant periods of time.
- Tabular values are for dry concrete and water saturated concrete conditions. Water-filled and submerged (underwater) applications are not permitted for this hole preparation method.
- Tabular values are for short term loads only. For sustained loads including overhead use, see Section 3.1.8.8.
- Tabular values are for normal-weight concrete only. For lightweight concrete multiply design strength by λ_a as follows: For sand-lightweight, $\lambda_a = 0.51$. For all-lightweight, $\lambda_a = 0.45$.
- Tabular values are for static loads only. Seismic design is not permitted for uncracked concrete. For seismic loads, multiply cracked concrete tabular values in tension and shear by $a_{seis} = 0.75$. See section 3.1.8.7 for additional information on seismic applications.

Table 49 - Steel design strength for steel bolt / cap screw for Hilti HIS-N and HIS-RN internally threaded inserts^{1,2,3}

Thread size	ASTM A 193 B7			ASTM A 193 Grade B8M stainless steel		
	Tensile ⁴ ΦN_{sa} lb (kN)	Shear ⁵ ΦV_{sa} lb (kN)	Seismic Shear ⁶ $\Phi V_{sa,seis}$ lb (kN)	Tensile ⁴ ΦN_{sa} lb (kN)	Shear ⁵ ΦV_{sa} lb (kN)	Seismic Shear ⁶ $\Phi V_{sa,seis}$ lb (kN)
3/8-16 UNC	6,300 (28.0)	3,490 (15.5)	2,445 (10.9)	5,540 (24.6)	3,070 (13.7)	2,150 (9.6)
1/2-13 UNC	10,525 (46.8)	6,385 (28.4)	4,470 (19.9)	10,145 (45.1)	5,620 (25.0)	3,935 (17.5)
5/8-11 UNC	17,500 (77.8)	10,170 (45.2)	7,120 (31.7)	16,160 (71.9)	8,950 (39.8)	6,265 (27.9)
3/4-10 UNC	17,785 (79.1)	15,055 (67.0)	10,540 (46.9)	23,915 (106.4)	13,245 (58.9)	9,270 (41.2)

- See Section 3.1.8.6 to convert design strength value to ASD value.
- Hilti HIS-N and HIS-RN inserts with steel bolts are considered brittle steel elements.
- Table values are the lesser of steel failure in the HIS-N insert or inserted steel bolt.
- Tensile = $\Phi A_{se,N} f_{uta}$ as noted in ACI 318 Chapter 17.
- Shear = $\Phi 0.60 A_{se,V} f_{uta}$ as noted in ACI 318 Chapter 17.
- Seismic Shear = $\alpha_{V,seis} \Phi V_{sa}$: Reduction for seismic shear only. See section 3.1.8.7 for additional information on seismic applications.

3.2.4 HIT-RE 500 V3 Epoxy Adhesive Anchoring System

Table 50 - Load adjustment factors for Hilti HIS-N and HIS-RN internally threaded inserts in uncracked concrete^{1,2}

HIS-N and HIS-RN all diameters uncracked concrete	Spacing factor in tension f_{AN}				Edge distance factor in tension f_{RN}				Spacing factor in shear ³ f_{AV}				Edge Distance in Shear								Concrete thickness factor in shear ⁴ f_{HV}				
													⊥ Toward edge f_{RV}				∥ To and away from edge f_{RV}								
													3/8 (9.5)	1/2 (12.7)	5/8 (15.9)	3/4 (19.1)	3/8 (9.5)	1/2 (12.7)	5/8 (15.9)	3/4 (19.1)					3/8 (9.5)
Internal diameter (mm)	3/8 (9.5)	1/2 (12.7)	5/8 (15.9)	3/4 (19.1)	3/8 (9.5)	1/2 (12.7)	5/8 (15.9)	3/4 (19.1)	3/8 (9.5)	1/2 (12.7)	5/8 (15.9)	3/4 (19.1)	3/8 (9.5)	1/2 (12.7)	5/8 (15.9)	3/4 (19.1)	3/8 (9.5)	1/2 (12.7)	5/8 (15.9)	3/4 (19.1)	3/8 (9.5)	1/2 (12.7)	5/8 (15.9)	3/4 (19.1)	
Embedment h_e (mm)	4-3/8 (111)	5 (127)	6-3/4 (171)	8-1/8 (206)	4-3/8 (111)	5 (127)	6-3/4 (171)	8-1/8 (206)	4-3/8 (111)	5 (127)	6-3/4 (171)	8-1/8 (206)	4-3/8 (111)	5 (127)	6-3/4 (171)	8-1/8 (206)	4-3/8 (111)	5 (127)	6-3/4 (171)	8-1/8 (206)	4-3/8 (111)	5 (127)	6-3/4 (171)	8-1/8 (206)	
Spacing (s) / edge distance (c _e) / concrete thickness (h _c) - in. (mm)	3-1/4 (83)	0.59	n/a	n/a	n/a	0.36	n/a	n/a	n/a	0.55	n/a	n/a	n/a	0.15	n/a	n/a	n/a	0.31	n/a	n/a	n/a	n/a	n/a	n/a	n/a
	4 (102)	0.61	0.59	n/a	n/a	0.41	0.40	n/a	n/a	0.56	0.55	n/a	n/a	0.21	0.19	n/a	n/a	0.41	0.38	n/a	n/a	n/a	n/a	n/a	n/a
	5 (127)	0.64	0.61	0.59	n/a	0.47	0.45	0.39	n/a	0.57	0.57	0.55	n/a	0.29	0.26	0.17	n/a	0.47	0.45	0.33	n/a	n/a	n/a	n/a	n/a
	5-1/2 (140)	0.65	0.62	0.60	0.59	0.50	0.48	0.41	0.37	0.58	0.58	0.56	0.55	0.34	0.30	0.19	0.15	0.50	0.48	0.39	0.29	n/a	n/a	n/a	n/a
	6 (152)	0.66	0.63	0.61	0.60	0.53	0.51	0.43	0.39	0.59	0.58	0.56	0.55	0.39	0.35	0.22	0.17	0.53	0.51	0.43	0.33	0.60	n/a	n/a	n/a
	7 (178)	0.69	0.65	0.62	0.61	0.61	0.57	0.48	0.42	0.60	0.60	0.57	0.56	0.49	0.43	0.28	0.21	0.61	0.57	0.48	0.42	0.64	0.62	n/a	n/a
	8 (203)	0.72	0.67	0.64	0.63	0.70	0.65	0.52	0.45	0.62	0.61	0.58	0.57	0.60	0.53	0.34	0.26	0.70	0.65	0.52	0.45	0.69	0.66	n/a	n/a
	9 (229)	0.74	0.70	0.66	0.65	0.78	0.73	0.57	0.49	0.63	0.62	0.59	0.58	0.71	0.63	0.40	0.31	0.78	0.73	0.57	0.49	0.73	0.70	n/a	n/a
	10 (254)	0.77	0.72	0.68	0.66	0.87	0.81	0.62	0.53	0.65	0.64	0.60	0.58	0.83	0.74	0.47	0.36	0.87	0.81	0.62	0.53	0.77	0.74	0.64	n/a
	11 (279)	0.80	0.74	0.69	0.68	0.96	0.89	0.68	0.56	0.66	0.65	0.61	0.59	0.96	0.86	0.55	0.41	0.96	0.89	0.68	0.56	0.81	0.78	0.67	0.61
	12 (305)	0.82	0.76	0.71	0.69	1.00	0.97	0.74	0.60	0.68	0.66	0.62	0.60	1.00	0.98	0.62	0.47	1.00	0.97	0.74	0.60	0.84	0.81	0.70	0.64
	14 (356)	0.88	0.80	0.75	0.73		1.00	0.86	0.70	0.71	0.69	0.64	0.62		1.00	0.78	0.59		1.00	0.86	0.70	0.91	0.87	0.75	0.69
	16 (406)	0.93	0.85	0.78	0.76			0.98	0.80	0.74	0.72	0.66	0.63			0.96	0.73			0.98	0.80	0.97	0.94	0.80	0.73
	18 (457)	0.99	0.89	0.82	0.79			1.00	0.90	0.77	0.75	0.68	0.65			1.00	0.87			1.00	0.90	1.00	0.99	0.85	0.78
	24 (610)	1.00	1.00	0.92	0.89				1.00	0.85	0.83	0.74	0.70				1.00				1.00	1.00	0.99	0.90	0.90
	30 (762)			1.00	0.98					0.94	0.91	0.80	0.75										1.00	0.99	0.90
	36 (914)				1.00					1.00	0.99	0.86	0.80												1.00
> 48 (1219)										0.99	0.90														

Table 51 - Load adjustment factors for Hilti HIS-N and HIS-RN internally threaded inserts in cracked concrete^{1,2}

HIS-N and HIS-RN all diameters cracked concrete	Spacing factor in tension f_{AN}				Edge distance factor in tension f_{RN}				Spacing factor in shear ³ f_{AV}				Edge Distance in Shear								Concrete thickness factor in shear ⁴ f_{HV}				
													⊥ Toward edge f_{RV}				∥ To and away from edge f_{RV}								
													3/8 (9.5)	1/2 (12.7)	5/8 (15.9)	3/4 (19.1)	3/8 (9.5)	1/2 (12.7)	5/8 (15.9)	3/4 (19.1)					3/8 (9.5)
Internal diameter (mm)	3/8 (9.5)	1/2 (12.7)	5/8 (15.9)	3/4 (19.1)	3/8 (9.5)	1/2 (12.7)	5/8 (15.9)	3/4 (19.1)	3/8 (9.5)	1/2 (12.7)	5/8 (15.9)	3/4 (19.1)	3/8 (9.5)	1/2 (12.7)	5/8 (15.9)	3/4 (19.1)	3/8 (9.5)	1/2 (12.7)	5/8 (15.9)	3/4 (19.1)	3/8 (9.5)	1/2 (12.7)	5/8 (15.9)	3/4 (19.1)	
Embedment h_e (mm)	4-3/8 (111)	5 (127)	6-3/4 (171)	8-1/8 (206)	4-3/8 (111)	5 (127)	6-3/4 (171)	8-1/8 (206)	4-3/8 (111)	5 (127)	6-3/4 (171)	8-1/8 (206)	4-3/8 (111)	5 (127)	6-3/4 (171)	8-1/8 (206)	4-3/8 (111)	5 (127)	6-3/4 (171)	8-1/8 (206)	4-3/8 (111)	5 (127)	6-3/4 (171)	8-1/8 (206)	
Spacing (s) / edge distance (c _e) / concrete thickness (h _c) - in. (mm)	3-1/4 (83)	0.59	n/a	n/a	n/a	0.54	n/a	n/a	n/a	0.55	n/a	n/a	n/a	0.16	n/a	n/a	n/a	0.31	n/a	n/a	n/a	n/a	n/a	n/a	n/a
	4 (102)	0.61	0.59	n/a	n/a	0.59	0.54	n/a	n/a	0.56	0.55	n/a	n/a	0.21	0.19	n/a	n/a	0.42	0.38	n/a	n/a	n/a	n/a	n/a	n/a
	5 (127)	0.64	0.61	0.59	n/a	0.66	0.60	0.54	n/a	0.57	0.57	0.55	n/a	0.30	0.26	0.17	n/a	0.59	0.53	0.34	n/a	n/a	n/a	n/a	n/a
	5-1/2 (140)	0.65	0.62	0.60	0.59	0.70	0.62	0.57	0.55	0.58	0.58	0.56	0.55	0.34	0.31	0.19	0.15	0.69	0.61	0.39	0.29	n/a	n/a	n/a	n/a
	6 (152)	0.66	0.63	0.61	0.60	0.74	0.65	0.59	0.57	0.59	0.58	0.56	0.55	0.39	0.35	0.22	0.17	0.74	0.65	0.44	0.34	0.60	n/a	n/a	n/a
	7 (178)	0.69	0.65	0.62	0.61	0.81	0.71	0.63	0.61	0.60	0.60	0.57	0.56	0.49	0.44	0.28	0.21	0.81	0.71	0.56	0.42	0.64	0.62	n/a	n/a
	8 (203)	0.72	0.67	0.64	0.63	0.89	0.77	0.68	0.65	0.62	0.61	0.58	0.57	0.60	0.54	0.34	0.26	0.89	0.77	0.68	0.52	0.69	0.66	n/a	n/a
	9 (229)	0.74	0.70	0.66	0.65	0.98	0.83	0.73	0.69	0.63	0.62	0.59	0.58	0.72	0.64	0.41	0.31	0.98	0.83	0.73	0.62	0.73	0.70	n/a	n/a
	10 (254)	0.77	0.72	0.68	0.66	1.00	0.90	0.78	0.73	0.65	0.64	0.60	0.58	0.84	0.75	0.48	0.36	1.00	0.90	0.78	0.72	0.77	0.74	0.64	n/a
	11 (279)	0.80	0.74	0.69	0.68		0.96	0.83	0.78	0.66	0.65	0.61	0.59	0.97	0.86	0.55	0.42		0.96	0.83	0.78	0.81	0.78	0.67	0.61
	12 (305)	0.82	0.76	0.71	0.69		1.00	0.88	0.83	0.68	0.66	0.62	0.60	1.00	0.98	0.63	0.48		1.00	0.88	0.83	0.84	0.81	0.70	0.64
	14 (356)	0.88	0.80	0.75	0.73			0.99	0.92	0.71	0.69	0.64	0.62		1.00	0.79	0.60			0.99	0.92	0.91	0.88	0.76	0.69
	16 (406)	0.93	0.85	0.78	0.76			1.00	1.00	0.74	0.72	0.66	0.64			0.97	0.73			1.00	1.00	0.97	0.94	0.81	0.74
	18 (457)	0.99	0.89	0.82	0.79					0.77	0.75	0.68	0.65			1.00	0.87					1.00	0.99	0.86	0.78
	24 (610)	1.00	1.00	0.92	0.89					0.86	0.83	0.74	0.70				1.00						1.00	0.99	0.90
	30 (762)			1.00	0.98					0.95	0.91	0.81	0.75											1.00	1.00
	36 (914)				1.00					1.00	0.99	0.87	0.80												
> 48 (1219)										1.00	0.99	0.91													

1 Linear interpolation not permitted.
 2 When combining multiple load adjustment factors (e.g. for a 4 anchor pattern in a corner with a thin concrete member) the design can become very conservative. To optimize the design, use Hilti PROFIS Anchor Design software or perform anchor calculation using the design equations from ACI 318 Chapter 17.
 3 Spacing factor reduction in shear, f_{AV} , assumes an influence of a nearby edge. If no edge exists, then $f_{AV} = f_{AN}$.
 4 Concrete thickness reduction factor in shear, f_{HV} , assumes an influence of a nearby edge. If no edge exists, then $f_{HV} = 1.0$.

HIT-RE 500 V3 Epoxy Adhesive Anchoring System 3.2.4

3.2.4.3.7 Canadian Limit State design

Limit State Design of anchors is described in the provisions of CSA A23.3-14 Annex D for post-installed anchors tested and assessed in accordance with ACI 355.2 for mechanical anchors and ACI 355.4 for adhesive anchors. This section contains the Limit State Design tables with unfactored characteristic loads that are based on the published loads in ICC Evaluation Services ESR-3814. These tables are followed by factored resistance tables. The factored resistance tables have characteristic design loads that are prefactored by the applicable reduction factors for a single anchor with no anchor-to-anchor spacing or edge distance adjustments for the convenience of the user of this document. All the figures in the previous ACI 318-14 Chapter 17 design section are applicable to Limit State Design and the tables will reference these figures.

For a detailed explanation of the tables developed in accordance with CSA A23.3-14 Annex D, refer to Section 3.1.8. Technical assistance is available by contacting Hilti Canada at (800) 363-4458 or at www.hilti.com.

Table 52 - Specifications for CA rebar installed with Hilti HIT-RE 500 V3 

Setting information		Symbol	Units	Rebar size				
				10M	15M	20M	25M	30M
Nominal bit diameter		d_o	in.	9/16	3/4	1	1-1/4	1-1/2
Effective embedment	minimum	$h_{ef,min}$	mm	60	80	90	100	120
	maximum	$h_{ef,max}$	mm	226	320	390	504	598
Minimum concrete member thickness		h_{min}	mm	$h_{ef} + 30$	$h_{ef} + 2d_o$			

Note: The installation specifications in table 52 above and the data in tables 53 through 67 pertain to the use of Hilti HIT-RE 500 V3 with rebar designed as a post-installed anchor using the provisions of CSA A23.3-14 Annex D. For the use of Hilti HIT-RE 500 V3 with rebar for typical development calculations according to CSA A23.3-14 Chapter 12, refer to section 3.1.8.14 for the design method and tables 88 through 92 in section 3.2.4.3.8.

3.2.4

Table 53 - Steel factored resistance for CA rebar¹ 

Rebar size	CSA-G30.18 Grade 400 ²		
	Tensile ³ N_{sar} lb (kN)	Shear ⁴ V_{sar} lb (kN)	Seismic shear ⁵ $V_{sar,eq}$ lb (kN)
10M	7,245 (32.2)	4,035 (17.9)	2,825 (12.6)
15M	14,525 (64.6)	8,090 (36.0)	5,665 (25.2)
20M	21,570 (95.9)	12,020 (53.5)	8,415 (37.4)
25M	36,025 (160.2)	20,070 (89.3)	14,050 (62.5)
30M	50,715 (225.6)	28,255 (125.7)	19,780 (88.0)

- 1 See Section 3.1.8.6 to convert design strength value to ASD value.
- 2 CSA-G30.18 Grade 400 rebar are considered ductile steel elements.
- 3 Tensile = $A_{se,N} \phi_s f_{uta} R$ as noted in CSA A23.3-14 Annex D
- 4 Shear = $A_{se,V} \phi_s 0.60 f_{uta} R$ as noted in CSA A23.3-14 Annex D.
- 5 Seismic Shear = $\alpha_{V,seis} V_{sar}$: Reduction factor for seismic shear only.
See section 3.1.8.7 for additional information on seismic applications.

3.2.4 HIT-RE 500 V3 Epoxy Adhesive Anchoring System

Table 54 - Hilti HIT-RE 500 V3 adhesive design information with CA rebar in hammer drilled holes in accordance with CSA A23.3-14 Annex D^{1,8}



Design parameter	Symbol	Units	Rebar size					Ref A23.3-14	
			10M	15M	20M	25M	30M		
Anchor O.D.	d_a	-	11.3	16.0	19.5	25.2	29.9		
Effective minimum embedment ²	h_{ef}	-	60	80	90	101	120		
Effective maximum embedment ²	h_{ef}	-	226	320	390	504	598		
Min. concrete thickness ²	h_{min}	-	$h_{ef} + 30$	$h_{ef} + 2d_a$					
Critical edge distance	c_{ac}	-	see ESR-3814, section 4.1.10						
Minimum edge distance	c_{min}^3	-	57	80	98	126	150		
Minimum anchor spacing	s_{min}	-	57	80	98	126	150		
Coeff. for factored conc. breakout resistance, uncracked concrete	$k_{c,uncr}^4$	-	10					D.6.2.2	
Coeff. for factored conc. breakout resistance, cracked concrete	$k_{c,cr}^4$	-	7					D.6.2.2	
Concrete material resistance factor	ϕ_c	-	0.65					8.4.2	
Resistance modification factor for tension and shear, concrete failure modes, Condition B ⁵	R_{conc}	-	1.00					D.5.3(c)	
Dry concrete and water saturated									
Temp. range A ⁶	Characteristic bond stress in cracked concrete ^{7,8}	τ_{cr}	psi (MPa)	1,360 (9.4)	1,390 (9.6)	1,410 (9.7)	1,420 (9.8)	1,380 (9.5)	D.6.5.2
	Characteristic bond stress in uncracked concrete ^{7,8}	τ_{uncr}	psi (MPa)	1,760 (12.1)	1,720 (11.9)	1,690 (11.7)	1,650 (11.4)	1,610 (11.1)	D.6.5.2
Temp. range B ⁶	Characteristic bond stress in cracked concrete ^{7,8}	τ_{cr}	psi (MPa)	940 (6.5)	960 (6.6)	970 (6.7)	980 (6.8)	950 (6.6)	D.6.5.2
	Characteristic bond stress in uncracked concrete ^{7,8}	τ_{uncr}	psi (MPa)	1,210 (8.3)	1,190 (8.2)	1,170 (8.1)	1,140 (7.9)	1,110 (7.7)	D.6.5.2
Anchor category, dry concrete	-	-	1	1	1	1	1	D.5.3(c)	
Resistance modification factor	R_{dry}	-	1.00	1.00	1.00	1.00	1.00		
Water-filled hole									
Temp. range A ⁶	Characteristic bond stress in cracked concrete ^{7,8}	τ_{cr}	psi (MPa)	1,010 (7.0)	1,040 (7.2)	1,060 (7.3)	1,080 (7.4)	1,060 (7.3)	D.6.5.2
	Characteristic bond stress in uncracked concrete ^{7,8}	τ_{uncr}^4	psi (MPa)	1,300 (9.0)	1,280 (8.8)	1,270 (8.8)	1,250 (8.6)	1,240 (8.6)	D.6.5.2
Temp. range B ⁶	Characteristic bond stress in cracked concrete ^{7,8}	τ_{cr}	psi (MPa)	700 (4.8)	720 (5.0)	730 (5.0)	740 (5.1)	730 (5.0)	D.6.5.2
	Characteristic bond stress in uncracked concrete ^{7,8}	τ_{uncr}	psi (MPa)	900 (6.2)	890 (6.1)	880 (6.1)	860 (5.9)	850 (5.9)	D.6.5.2
Anchor category, water-filled hole	-	-	3	3	3	3	3	D.5.3(c)	
Resistance modification factor	R_{wf}	-	0.75	0.75	0.75	0.75	0.75		
Underwater application									
Temp. range A ⁶	Characteristic bond stress in cracked concrete ^{7,8}	τ_{cr}	psi (MPa)	880 (6.1)	920 (6.3)	940 (6.5)	980 (6.8)	960 (6.6)	D.6.5.2
	Characteristic bond stress in uncracked concrete ^{7,8}	τ_{uncr}	psi (MPa)	1,130 (7.8)	1,140 (7.9)	1,140 (7.9)	1,140 (7.9)	1,130 (7.8)	D.6.5.2
Temp. range B ⁶	Characteristic bond stress in cracked concrete ^{7,8}	τ_{cr}	psi (MPa)	610 (4.2)	630 (4.3)	650 (4.5)	680 (4.7)	660 (4.6)	D.6.5.2
	Characteristic bond stress in uncracked concrete ^{7,8}	τ_{uncr}	psi (MPa)	780 (5.4)	790 (5.4)	780 (5.4)	780 (5.4)	780 (5.4)	D.6.5.2
Anchor category, underwater	-	-	3	3	3	3	3	D.5.3(c)	
Resistance modification factor	R_{LW}	-	0.75	0.75	0.75	0.75	0.75		
Resistance for seismic tension	$\alpha_{N,seis}$	-	0.90	0.90	0.90	0.90	0.90		

1 Design information in this table is taken from ICC-ES ESR-3814, dated January, 2016, table 23 and 24, and converted for use with CSA A23.3-14 Annex D.

2 See figure 2 of section 3.2.4.3.1.

3 Minimum edge distance may be reduced to 45mm provided rebar remains untorqued. See ESR-3814 section 4.1.9.

4 For all design cases, $\psi_{c,N} = 1.0$. The appropriate coefficient for breakout resistance for cracked concrete ($k_{c,cr}$) or uncracked concrete ($k_{c,uncr}$) must be used.

5 For use with the load combinations of CSA A23.3-14 chapter 8. Condition B applies where supplementary reinforcement in conformance with CSA A23.3-14 section D.5.3 is not provided, or where pullout or pryout strength governs. For cases where the presence of supplementary reinforcement can be verified, the resistance modification factors associated with Condition A may be used.

6 Temperature range A: Max. short term temperature = 130°F (55°C), max. long term temperature = 110°F (43°C).

Temperature range B: Max. short term temperature = 176°F (80°C), max. long term temperature = 110°F (43°C).

Short term elevated concrete temperatures are those that occur over brief intervals, e.g., as a result of diurnal cycling. Long term concrete temperatures are roughly constant over significant periods of time.

7 Bond stress values corresponding to concrete compressive stress $f'_c = 2,500$ psi (17.2 MPa). For concrete compressive strength, f'_c , between 2,500 psi (17.2 MPa) and 8,000 psi (55.2 MPa), the tabulated characteristic bond stress may be increased by a factor of $(f'_c/2,500)^{0.25}$ [for SI: $(f'_c/17.2)^{0.25}$] for uncracked concrete and $(f'_c/2,500)^{0.15}$ [for SI: $(f'_c/17.2)^{0.15}$] for cracked concrete.

8 For structures assigned to Seismic Design Categories C, D, E, or F, bond stress values must be multiplied by $\alpha_{N,seis}$.

HIT-RE 500 V3 Epoxy Adhesive Anchoring System 3.2.4

Table 55 - Hilti HIT-RE 500 V3 adhesive design information with CA rebar in diamond core drilled holes in accordance with CSA A23.3-14 Annex D¹



Design parameter	Symbol	Units	Rebar size					Ref A23.3-14
			10M	15M	20M	25M	30M	
Anchor O.D.	d_a	-	11.3	16.0	19.5	25.2	29.9	
Effective minimum embedment ²	h_{ef}	-	60	80	90	101	120	
Effective maximum embedment ²	h_{ef}	-	226	320	390	504	598	
Min. concrete thickness ²	h_{min}	-	$h_{ef} + 30$	$h_{ef} + 2d_o$				
Critical edge distance	c_{ac}	-	see ESR-3814, section 4.1.10					
Minimum edge distance	c_{min}^3	-	57	80	98	126	150	
Minimum anchor spacing	s_{min}	-	57	80	98	126	150	
Coeff. for factored conc. breakout resistance, uncracked concrete	$k_{c,unscr}^4$	-	10					D.6.2.2
Coeff. for factored conc. breakout resistance, cracked concrete	$k_{c,scr}^4$	-	7					D.6.2.2
Concrete material resistance factor	ϕ_c	-	0.65					8.4.2
Resistance modification factor for tension and shear, concrete failure modes, Condition B ⁵	R_{conc}	-	1.00					D.5.3(c)
Dry concrete and water saturated concrete								
Temp. range A	Characteristic bond stress in cracked concrete ^{7,8}	psi	1,150	1,150	1,150	1,150	1,150	D.6.5.2
		(MPa)	(7.9)	(7.9)	(7.9)	(7.9)	(7.9)	
Temp. range B	Characteristic bond stress in uncracked concrete ^{7,8}	psi	800	800	800	800	800	D.6.5.2
		(MPa)	(5.5)	(5.5)	(5.5)	(5.5)	(5.5)	
Anchor category, dry concrete		-	2	3	3	3	3	D.5.3(c)
Resistance modification factor		R_{dry}	0.85	0.75	0.75	0.75	0.75	

1 Design information in this table is taken from ICC-ES ESR-3814, dated January, 2016, table 23 and 25B, and converted for use with CSA A23.3-14 Annex D.

2 See figure 2 of section 3.2.4.3.1.

3 Minimum edge distance may be reduced to 45mm provided rebar remains untorqued. See ESR-3814 section 4.1.9.

4 For all design cases, $\psi_{c,N} = 1.0$. The appropriate coefficient for breakout resistance for cracked concrete ($k_{c,scr}$) or uncracked concrete ($k_{c,unscr}$) must be used.

5 For use with the load combinations of CSA A23.3-14 chapter 8. Condition B applies where supplementary reinforcement in conformance with CSA A23.3-14 section D.5.3 is not provided, or where pullout or pryout strength governs. For cases where the presence of supplementary reinforcement can be verified, the resistance modification factors associated with Condition A may be used.

6 Temperature range A: Max. short term temperature = 130°F (55°C), max. long term temperature = 110°F (43°C).

Temperature range B: Max. short term temperature = 176°F (80°C), max. long term temperature = 110°F (43°C).

Short term elevated concrete temperatures are those that occur over brief intervals, e.g., as a result of diurnal cycling. Long term concrete temperatures are roughly constant over significant periods of time.

7 Bond stress values correspond to concrete compressive strength $f'_c = 2,500$ psi (17.2 MPa). For concrete compressive strength, f'_c , between 2,500 psi (17.2 MPa) and 8,000 psi (55.2 MPa), the tabulated characteristic bond stress may be increased by a factor of $(f'_c/2,500)^{0.25}$ [for SI: $(f'_c/17.2)^{0.25}$] for uncracked concrete.

3.2.4 HIT-RE 500 V3 Epoxy Adhesive Anchoring System

Table 56 - Hilti HIT-RE 500 V3 adhesive factored resistance with concrete/bond failure for CA rebar in uncracked concrete^{1,2,3,4,5,6,7,8,9,10,11}



Rebar size	Effective embedment in. (mm)	Tension N_t				Shear V_r			
		$f'_c = 20$ MPa (2,900 psi) lb (kN)	$f'_c = 25$ MPa (3,625 psi) lb (kN)	$f'_c = 30$ MPa (4,350 psi) lb (kN)	$f'_c = 40$ MPa (5,800 psi) lb (kN)	$f'_c = 20$ MPa (2,900 psi) lb (kN)	$f'_c = 25$ MPa (3,625 psi) lb (kN)	$f'_c = 30$ MPa (4,350 psi) lb (kN)	$f'_c = 40$ MPa (5,800 psi) lb (kN)
10M	4-1/2 (115)	7,520 (33.4)	7,950 (35.4)	8,320 (37.0)	8,940 (39.8)	15,040 (66.9)	15,900 (70.7)	16,645 (74.0)	17,885 (79.6)
	7-1/16 (180)	11,770 (52.4)	12,445 (55.4)	13,025 (57.9)	13,995 (62.3)	23,540 (104.7)	24,890 (110.7)	26,050 (115.9)	27,990 (124.5)
	8-7/8 (226)	14,775 (65.7)	15,625 (69.5)	16,355 (72.7)	17,575 (78.2)	29,555 (131.5)	31,250 (139.0)	32,705 (145.5)	35,145 (156.3)
15M ¹⁰	5-11/16 (145)	11,410 (50.8)	12,755 (56.7)	13,975 (62.2)	15,600 (69.4)	22,820 (101.5)	25,515 (113.5)	27,950 (124.3)	31,205 (138.8)
	9-13/16 (250)	22,620 (100.6)	23,915 (106.4)	25,030 (111.3)	26,900 (119.7)	45,240 (201.2)	47,835 (212.8)	50,065 (222.7)	53,800 (239.3)
	12-5/8 (320)	28,950 (128.8)	30,615 (136.2)	32,040 (142.5)	34,430 (153.2)	57,905 (257.6)	61,225 (272.3)	64,080 (285.1)	68,860 (306.3)
20M ¹⁰	7-7/8 (200)	18,485 (82.2)	20,665 (91.9)	22,640 (100.7)	25,770 (114.6)	36,965 (164.4)	41,330 (183.8)	45,275 (201.4)	51,540 (229.3)
	14 (355)	38,460 (171.1)	40,670 (180.9)	42,565 (189.3)	45,740 (203.5)	76,925 (342.2)	81,340 (361.8)	85,130 (378.7)	91,480 (406.9)
	15-3/8 (390)	42,255 (188.0)	44,680 (198.7)	46,760 (208.0)	50,250 (223.5)	84,510 (375.9)	89,355 (397.5)	93,525 (416.0)	100,500 (447.0)
25M	9-1/16 (230)	22,795 (101.4)	25,485 (113.4)	27,920 (124.2)	32,235 (143.4)	45,590 (202.8)	50,970 (226.7)	55,835 (248.4)	64,475 (286.8)
	15-15/16 (405)	53,265 (236.9)	58,540 (260.4)	61,270 (272.5)	65,840 (292.9)	106,525 (473.9)	117,080 (520.8)	122,540 (545.1)	131,680 (585.7)
	19-13/16 (504)	68,895 (306.5)	72,850 (324.1)	76,245 (339.2)	81,935 (364.5)	137,795 (612.9)	145,700 (648.1)	152,495 (678.3)	163,865 (728.9)
30M	10-1/4 (260)	27,395 (121.9)	30,630 (136.3)	33,555 (149.3)	38,745 (172.3)	54,795 (243.7)	61,260 (272.5)	67,110 (298.5)	77,490 (344.7)
	17-15/16 (455)	63,425 (282.1)	70,910 (315.4)	77,680 (345.5)	85,635 (380.9)	126,850 (564.3)	141,825 (630.9)	155,360 (691.1)	171,270 (761.8)
	23-9/16 (598)	94,640 (421.0)	100,070 (445.1)	104,740 (465.9)	112,550 (500.6)	189,285 (842.0)	200,145 (890.3)	209,475 (931.8)	225,100 (1001.3)

1 See Section 3.1.8 for explanation on development of load values.

2 See Section 3.1.8.6 to convert design strength value to ASD value.

3 Linear interpolation between embedment depths and concrete compressive strengths is not permitted.

4 Apply spacing, edge distance, and concrete thickness factors in tables 61-70 as necessary to the above values. Compare to the steel values in table 53. The lesser of the values is to be used for the design.

5 Data is for temperature range A: Max. short term temperature = 130°F (55°C), max. long term temperature = 110°F (43°C).

For temperature range B: Max. short term temperature = 176°F (80°C), max. long term temperature = 110°F (43°C) multiply above values by 0.69.

Short term elevated concrete temperatures are those that occur over brief intervals, e.g., as a result of diurnal cycling. Long term concrete temperatures are roughly constant over significant periods of time.

6 Tabular values are for dry concrete and water-saturated concrete conditions.

For water-filled drilled holes multiply design strength by 0.51.

For submerged (under water) applications multiply design strength by 0.45.

7 Tabular values are for short term loads only. For sustained loads including overhead use, see Section 3.1.8.8.

8 Tabular values are for normal-weight concrete only. For lightweight concrete multiply design strength by λ_a as follows:

For sand-lightweight, $\lambda_a = 0.51$. For all-lightweight, $\lambda_a = 0.45$.

9 Tabular values are for holes drilled in concrete with carbide tipped hammer drill bit. For diamond core drilling, except as indicated in note 10, multiply above values by 0.48.

Diamond core drilling is not permitted for the water-filled or under-water (submerged) applications.

10 Diamond core drilling with Hilti TE-YRT roughening tool is permitted for 15M and 20M diameter anchors for dry and water-saturated concrete conditions. See Table 59.

11 Tabular values are for static loads only. Seismic design is not permitted for uncracked concrete.

HIT-RE 500 V3 Epoxy Adhesive Anchoring System 3.2.4

Table 57 - Hilti HIT-RE 500 V3 adhesive factored resistance with concrete/bond failure for CA rebar in cracked concrete^{1,2,3,4,5,6,7,8,9,10}



Rebar size	Effective embedment in. (mm)	Tension N_t				Shear V_t			
		$f'_c = 20$ MPa (2,900 psi) lb (kN)	$f'_c = 25$ MPa (3,625 psi) lb (kN)	$f'_c = 30$ MPa (4,350 psi) lb (kN)	$f'_c = 40$ MPa (5,800 psi) lb (kN)	$f'_c = 20$ MPa (2,900 psi) lb (kN)	$f'_c = 25$ MPa (3,625 psi) lb (kN)	$f'_c = 30$ MPa (4,350 psi) lb (kN)	$f'_c = 40$ MPa (5,800 psi) lb (kN)
10M	4-1/2 (115)	5,640 (25.1)	5,920 (26.3)	6,080 (27.1)	6,350 (28.2)	11,285 (50.2)	11,835 (52.7)	12,165 (54.1)	12,700 (56.5)
	7-1/16 (180)	8,960 (39.8)	9,265 (41.2)	9,520 (42.3)	9,940 (44.2)	17,915 (79.7)	18,525 (82.4)	19,040 (84.7)	19,880 (88.4)
	8-7/8 (226)	11,250 (50.0)	11,630 (51.7)	11,955 (53.2)	12,480 (55.5)	22,495 (100.1)	23,260 (103.5)	23,905 (106.3)	24,960 (111.0)
15M ¹⁰	5-11/16 (145)	7,985 (35.5)	8,930 (39.7)	9,780 (43.5)	11,295 (50.2)	15,975 (71.1)	17,860 (79.4)	19,565 (87.0)	22,590 (100.5)
	9-13/16 (250)	18,005 (80.1)	18,620 (82.8)	19,135 (85.1)	19,980 (88.9)	36,010 (160.2)	37,235 (165.6)	38,270 (170.2)	39,955 (177.7)
	12-5/8 (320)	23,045 (102.5)	23,830 (106.0)	24,495 (108.9)	25,575 (113.8)	46,095 (205.0)	47,665 (212.0)	48,985 (217.9)	51,145 (227.5)
20M ¹⁰	7-7/8 (200)	12,940 (57.6)	14,465 (64.3)	15,845 (70.5)	18,300 (81.4)	25,875 (115.1)	28,930 (128.7)	31,695 (141.0)	36,595 (162.8)
	14 (355)	30,595 (136.1)	32,685 (145.4)	33,590 (149.4)	35,075 (156.0)	61,195 (272.2)	65,370 (290.8)	67,185 (298.8)	70,145 (312.0)
	15-3/8 (390)	34,725 (154.5)	35,910 (159.7)	36,905 (164.2)	38,530 (171.4)	69,450 (308.9)	71,815 (319.5)	73,805 (328.3)	77,060 (342.8)
25M	9-1/16 (230)	15,955 (71.0)	17,840 (79.4)	19,540 (86.9)	22,565 (100.4)	31,915 (142.0)	35,680 (158.7)	39,085 (173.9)	45,130 (200.8)
	15-15/16 (405)	37,285 (165.8)	41,685 (185.4)	45,665 (203.1)	52,075 (231.6)	74,570 (331.7)	83,370 (370.8)	91,325 (406.2)	104,150 (463.3)
	19-13/16 (504)	51,760 (230.2)	57,870 (257.4)	62,070 (276.1)	64,805 (288.3)	103,520 (460.5)	115,735 (514.8)	124,135 (552.2)	129,610 (576.5)
30M	10-1/4 (260)	19,180 (85.3)	21,440 (95.4)	23,490 (104.5)	27,120 (120.6)	38,355 (170.6)	42,885 (190.8)	46,975 (209.0)	54,245 (241.3)
	17-15/16 (455)	44,400 (197.5)	49,640 (220.8)	54,375 (241.9)	62,790 (279.3)	88,795 (395.0)	99,275 (441.6)	108,750 (483.7)	125,575 (558.6)
	23-9/16 (598)	66,895 (297.6)	74,790 (332.7)	81,930 (364.4)	88,665 (394.4)	133,790 (595.1)	149,580 (665.4)	163,860 (728.9)	177,325 (788.8)



3.2.4

- See Section 3.1.8 for explanation on development of load values.
- See Section 3.1.8.6 to convert design strength value to ASD value.
- Linear interpolation between embedment depths and concrete compressive strengths is not permitted.
- Apply spacing, edge distance, and concrete thickness factors in tables 61-70 as necessary to the above values. Compare to the steel values in table 53. The lesser of the values is to be used for the design.
- Data is for temperature range A: Max. short term temperature = 130°F (55°C), max. long term temperature = 110°F (43°C).
For temperature range B: Max. short term temperature = 176°F (80°C), max. long term temperature = 110°F (43°C) multiply above values by 0.69.
Short term elevated concrete temperatures are those that occur over brief intervals, e.g., as a result of diurnal cycling. Long term concrete temperatures are roughly constant over significant periods of time.
- Tabular values are for dry concrete and water-saturated concrete conditions.
For water-filled drilled holes multiply design strength by 0.51.
For submerged (under water) applications multiply design strength by 0.45.
- Tabular values are for short term loads only. For sustained loads including overhead use, see Section 3.1.8.8.
- Tabular values are for normal-weight concrete only. For lightweight concrete multiply design strength by λ_a as follows:
For sand-lightweight, $\lambda_a = 0.51$. For all-lightweight, $\lambda_a = 0.45$.
- Tabular values are for holes drilled in concrete with carbide tipped hammer drill bit. Diamond core drilling is not permitted in cracked concrete conditions except as indicated in note 10.
- Diamond core drilling with Hilti TE-YRT roughening tool is permitted for 15M and 20M diameter anchors for dry and water-saturated concrete conditions. See Table 60.
- Tabular values are for static loads only. For seismic loads, multiply cracked concrete tabular values by $\alpha_{seis} = 0.68$. See section 3.1.8.7 for additional information on seismic applications.

3.2.4 HIT-RE 500 V3 Epoxy Adhesive Anchoring System

Table 58 - Hilti HIT-RE 500 V3 adhesive design information with CA rebar in core drilled holes roughened with the TE-YRT Roughening Tool in accordance with CSA A23.3-14 Annex D^{1,9}



Design parameter	Symbol	Units	Rebar size		Ref A23.3-14	
			15M	20M		
Anchor O.D.	d_a	-	16.0	19.5		
Effective minimum embedment ²	h_{ef}	-	80	90		
Effective maximum embedment ²	h_{ef}	-	320	390		
Min. concrete thickness ²	h_{min}	-	$h_{ef} + 2d_0$			
Critical edge distance	c_{ac}	-				
Minimum edge distance	c_{min}^3	-	80	98		
Minimum anchor spacing	s_{min}	-	80	98		
Coeff. for factored conc. breakout resistance, uncracked concrete	$k_{c,uncr}^4$	-	10		D.6.2.2	
Coeff. for factored conc. breakout resistance, cracked concrete	$k_{c,cr}^4$	-	7		D.6.2.2	
Concrete material resistance factor	ϕ_c	-	0.65		8.4.2	
Resistance modification factor for tension and shear, concrete failure modes, Condition B ⁵	R_{conc}	-	1.00		D.5.3 (c)	
Dry concrete and water saturated concrete						
Temp. range A ⁶	Characteristic bond stress in cracked concrete ^{6,7}	T_{cr}	psi (MPa)	970 (6.7)	985 (6.8)	D.6.5.2
	Characteristic bond stress in uncracked concrete ^{6,7}	T_{uncr}	psi (MPa)	1,720 (11.9)	1,690 (11.7)	D.6.5.2
Temp. range B ⁶	Characteristic bond stress in cracked concrete ^{6,7}	T_{cr}	psi (MPa)	670 (4.6)	680 (4.7)	D.6.5.2
	Characteristic bond stress in uncracked concrete ^{6,7}	T_{uncr}	psi (MPa)	1,190 (8.2)	1,170 (8.1)	D.6.5.2
Anchor category, dry concrete		-	-	1	1	D.5.3(c)
Resistance modification factor		R_{dry}	-	1.00	1.00	
Reduction for Seismic Tension		$\alpha_{N,seis}$	-	0.90	0.90	

1 Design information in this table is taken from ICC-ES ESR-3814, dated November 2016, table 23 and 25A, and converted for use with CSA A23.3-14 Annex D.

2 See figure 2 of section 3.2.4.3.4.

3 Minimum edge distance may be reduced to 45mm provided rebar remains untorqued. See ESR-3814 section 4.1.9.

4 For all design cases, $\psi_c N = 1.0$. The appropriate coefficient for breakout resistance for cracked concrete ($k_{c,cr}$) or uncracked concrete ($k_{c,uncr}$) must be used.

5 For use with the load combinations of CSA A23.3-14 chapter 8. Condition B applies where supplementary reinforcement in conformance with CSA A23.3-14 section D.5.3 is not provided, or where pullout or pryout strength governs. For cases where the presence of supplementary reinforcement can be verified, the resistance modification factors associated with Condition A may be used.

6 Temperature range A: Max. short term temperature = 130°F (55°C), max. long term temperature = 110°F (43°C). Temperature range B: Max. short term temperature = 176°F (80°C), max. long term temperature = 110°F (43°C). Short term elevated concrete temperatures are those that occur over brief intervals, e.g., as a result of diurnal cycling. Long term concrete temperatures are roughly constant over significant periods of time.

7 Bond stress values correspond to concrete compressive strength in the range 2,500 psi \leq $f'_c \leq$ 8,000 psi.

8 For structures assigned to Seismic Design Categories C, D, E, or F, bond stress values must be multiplied by $\alpha_{N,seis}$.

HIT-RE 500 V3 Epoxy Adhesive Anchoring System 3.2.4

Table 59 - Hilti HIT-RE 500 V3 adhesive factored resistance for core drilled holes roughened with Hilti TE-YRT roughening tool with concrete / bond failure for CA rebar in uncracked concrete^{1,2,3,4,5,6,7,8,9}



Rebar size	Effective embedment in. (mm)	Tension - N_r				Shear - V_r			
		$f'_c = 20$ MPa (2,900psi) lb (kN)	$f'_c = 25$ MPa (3,625 psi) lb (kN)	$f'_c = 30$ MPa (4,350 psi) lb (kN)	$f'_c = 40$ MPa (5,800 psi) lb (kN)	$f'_c = 20$ MPa (2,900 psi) lb (kN)	$f'_c = 25$ MPa (3,625 psi) lb (kN)	$f'_c = 30$ MPa (4,350 psi) lb (kN)	$f'_c = 40$ MPa (5,800 psi) lb (kN)
15M	5-11/16 (145)	11,410 (50.8)	12,635 (56.2)	12,635 (56.2)	12,635 (56.2)	22,820 (101.5)	25,265 (112.4)	25,265 (112.4)	25,265 (112.4)
	9-13/16 (250)	21,780 (96.9)	21,780 (96.9)	21,780 (96.9)	21,780 (96.9)	43,565 (193.8)	43,565 (193.8)	43,565 (193.8)	43,565 (193.8)
	12-5/8 (320)	27,880 (124.0)	27,880 (124.0)	27,880 (124.0)	27,880 (124.0)	55,760 (248.0)	55,760 (248.0)	55,760 (248.0)	55,760 (248.0)
20M	7-7/8 (200)	18,485 (82.2)	20,665 (91.9)	20,865 (92.8)	20,865 (92.8)	36,965 (164.4)	41,330 (183.8)	41,735 (185.6)	41,735 (185.6)
	14 (355)	37,040 (164.8)	37,040 (164.8)	37,040 (164.8)	37,040 (164.8)	74,080 (329.5)	74,080 (329.5)	74,080 (329.5)	74,080 (329.5)
	15-3/8 (390)	40,690 (181.0)	40,690 (181.0)	40,690 (181.0)	40,690 (181.0)	81,380 (362.0)	81,380 (362.0)	81,380 (362.0)	81,380 (362.0)

- See Section 3.1.8 for explanation on development of load values.
- See Section 3.1.8.6 to convert design strength value to ASD value.
- Linear interpolation between embedment depths and concrete compressive strengths is not permitted.
- Apply spacing, edge distance, and concrete thickness factors in tables 61-70 as necessary to the above values. Compare to the steel values in table 53. The lesser of the values is to be used for the design.
- Data is for temperature range A: Max. short term temperature = 130°F (55°C), max. long term temperature = 110°F (43°C).
For temperature range B: Max. short term temperature = 176°F (80°C), max. long term temperature = 110°F (43°C) multiply above values by 0.69.
Short term elevated concrete temperatures are those that occur over brief intervals, e.g., as a result of diurnal cycling. Long term concrete temperatures are roughly constant over significant periods of time.
- Tabular values are for dry concrete or water-saturated concrete conditions. Water-filled and submerged (under water) applications are not permitted for this hole preparation method.
- Tabular values are for short term loads only. For sustained loads including overhead use, see Section 3.1.8.8.
- Tabular values are for normal-weight concrete only. For lightweight concrete multiply design strength by λ_a as follows:
For sand-lightweight, $\lambda_a = 0.51$. For all lightweight, $\lambda_a = 0.45$.
- Tabular values are for static loads only. Seismic design is not permitted for uncracked concrete.



3.2.4

Table 60 - Hilti HIT-RE 500 V3 adhesive factored resistance for core drilled holes roughened with Hilti TE-YRT roughening tool with concrete / bond failure for CA rebar in cracked concrete^{1,2,3,4,5,6,7,8,9}



Rebar size	Effective embedment in. (mm)	Tension - N_r				Shear - V_r			
		$f'_c = 20$ MPa (2,900psi) lb (kN)	$f'_c = 25$ MPa (3,625 psi) lb (kN)	$f'_c = 30$ MPa (4,350 psi) lb (kN)	$f'_c = 40$ MPa (5,800 psi) lb (kN)	$f'_c = 20$ MPa (2,900 psi) lb (kN)	$f'_c = 25$ MPa (3,625 psi) lb (kN)	$f'_c = 30$ MPa (4,350 psi) lb (kN)	$f'_c = 40$ MPa (5,800 psi) lb (kN)
15M	5-11/16 (145)	7,125 (31.7)	7,125 (31.7)	7,125 (31.7)	7,125 (31.7)	14,250 (63.4)	14,250 (63.4)	14,250 (63.4)	14,250 (63.4)
	9-13/16 (250)	12,285 (54.6)	12,285 (54.6)	12,285 (54.6)	12,285 (54.6)	24,570 (109.3)	24,570 (109.3)	24,570 (109.3)	24,570 (109.3)
	12-5/8 (320)	15,725 (69.9)	15,725 (69.9)	15,725 (69.9)	15,725 (69.9)	31,445 (139.9)	31,445 (139.9)	31,445 (139.9)	31,445 (139.9)
20M	7-7/8 (200)	12,160 (54.1)	12,160 (54.1)	12,160 (54.1)	12,160 (54.1)	24,325 (108.2)	24,325 (108.2)	24,325 (108.2)	24,325 (108.2)
	14 (355)	21,590 (96.0)	21,590 (96.0)	21,590 (96.0)	21,590 (96.0)	43,175 (192.1)	43,175 (192.1)	43,175 (192.1)	43,175 (192.1)
	15-3/8 (390)	23,715 (105.5)	23,715 (105.5)	23,715 (105.5)	23,715 (105.5)	47,435 (211.0)	47,435 (211.0)	47,435 (211.0)	47,435 (211.0)

- See Section 3.1.8 for explanation on development of load values.
- See Section 3.1.8.6 to convert design strength value to ASD value.
- Linear interpolation between embedment depths and concrete compressive strengths is not permitted.
- Apply spacing, edge distance, and concrete thickness factors in tables 61-70 as necessary to the above values. Compare to the steel values in table 53. The lesser of the values is to be used for the design.
- Data is for temperature range A: Max. short term temperature = 130°F (55°C), max. long term temperature = 110°F (43°C).
For temperature range B: Max. short term temperature = 176°F (80°C), max. long term temperature = 110°F (43°C) multiply above values by 0.69.
Short term elevated concrete temperatures are those that occur over brief intervals, e.g., as a result of diurnal cycling. Long term concrete temperatures are roughly constant over significant periods of time.
- Tabular values are for dry concrete or water-saturated concrete conditions. Water-filled and submerged (under water) applications are not permitted for this hole preparation method.
Tabular values are for short term loads only. For sustained loads including overhead use, see Section 3.1.8.8.
- Tabular values are for normal-weight concrete only. For lightweight concrete multiply design strength by λ_a as follows:
For sand-lightweight, $\lambda_a = 0.51$. For all-lightweight, $\lambda_a = 0.45$.
- Tabular values are for static loads only. For seismic loads, multiply cracked concrete tabular values by $\alpha_{seis}=0.675$. See section 3.1.8.7 for additional information on seismic applications.

3.2.4 HIT-RE 500 V3 Epoxy Adhesive Anchoring System

Table 61 - Load adjustment factors for 10M rebar in uncracked concrete^{1,2,3}



10M uncracked concrete	Spacing factor in tension			Edge distance factor in tension			Spacing factor in shear ⁴			Edge distance in shear						Concrete thickness factor in shear ⁵			
										⊥ Toward edge			∥ To and away from edge						
	f_{AN}	f_{RN}	f_{AV}	f_{RV}	f_{RV}	f_{RV}	f_{RV}	f_{RV}	f_{HV}										
Embedment h_{ef} in. (mm)	4-1/2 (115)	7-1/16 (180)	8-7/8 (226)	4-1/2 (115)	7-1/16 (180)	8-7/8 (226)	4-1/2 (115)	7-1/16 (180)	8-8/9 (226)	4-1/2 (115)	7-1/16 (180)	8-7/8 (226)	4-1/2 (115)	7-1/16 (180)	8-7/8 (226)	4-1/2 (115)	7-1/16 (180)	8-7/8 (226)	
Spacing (s) / edge distance (c _e) / concrete thickness (h _c) - in. (mm)	1-3/4 (44)	n/a	n/a	n/a	0.24	0.15	0.12	n/a	n/a	n/a	0.06	0.04	0.03	0.11	0.07	0.06	n/a	n/a	n/a
	2-3/16 (55)	0.58	0.55	0.54	0.26	0.16	0.13	0.53	0.52	0.52	0.08	0.05	0.04	0.15	0.10	0.08	n/a	n/a	n/a
	3 (76)	0.61	0.57	0.56	0.30	0.19	0.15	0.54	0.53	0.53	0.12	0.08	0.06	0.25	0.16	0.13	n/a	n/a	n/a
	4 (102)	0.65	0.59	0.57	0.35	0.22	0.17	0.56	0.54	0.54	0.19	0.12	0.10	0.35	0.22	0.17	n/a	n/a	n/a
	5 (127)	0.68	0.62	0.59	0.41	0.25	0.20	0.57	0.55	0.54	0.27	0.17	0.14	0.41	0.25	0.20	n/a	n/a	n/a
	5-11/16 (145)	0.71	0.63	0.61	0.45	0.28	0.22	0.58	0.56	0.55	0.33	0.21	0.17	0.45	0.28	0.22	0.56	n/a	n/a
	6 (152)	0.72	0.64	0.61	0.47	0.29	0.23	0.58	0.56	0.55	0.35	0.22	0.18	0.47	0.29	0.23	0.58	n/a	n/a
	7 (178)	0.76	0.66	0.63	0.54	0.34	0.27	0.60	0.57	0.56	0.44	0.28	0.23	0.54	0.34	0.27	0.62	n/a	n/a
	8 (203)	0.79	0.69	0.65	0.62	0.38	0.30	0.61	0.58	0.57	0.54	0.35	0.28	0.62	0.38	0.30	0.67	n/a	n/a
	8-1/4 (210)	0.80	0.69	0.65	0.64	0.40	0.31	0.61	0.58	0.57	0.57	0.36	0.29	0.64	0.40	0.31	0.68	0.58	n/a
	9 (229)	0.83	0.71	0.67	0.70	0.43	0.34	0.62	0.59	0.58	0.65	0.41	0.33	0.70	0.43	0.34	0.71	0.61	n/a
	10-1/16 (256)	0.87	0.74	0.69	0.78	0.48	0.38	0.64	0.60	0.59	0.76	0.49	0.39	0.78	0.48	0.38	0.75	0.64	0.60
	11 (279)	0.90	0.76	0.71	0.85	0.53	0.42	0.65	0.61	0.60	0.87	0.56	0.44	0.85	0.53	0.42	0.78	0.67	0.62
	12 (305)	0.94	0.78	0.72	0.93	0.58	0.45	0.67	0.62	0.61	0.99	0.63	0.51	0.93	0.58	0.45	0.81	0.70	0.65
	14 (356)	1.00	0.83	0.76	1.00	0.67	0.53	0.69	0.64	0.62	1.00	0.80	0.64	1.00	0.67	0.53	0.88	0.76	0.70
	16 (406)		0.88	0.80		0.77	0.61	0.72	0.66	0.64		0.98	0.78		0.77	0.61	0.94	0.81	0.75
	18 (457)		0.92	0.84		0.87	0.68	0.75	0.68	0.66		1.00	0.93		0.87	0.68	1.00	0.86	0.80
	24 (610)		1.00	0.95		1.00	0.91	0.83	0.75	0.71		1.00			1.00	0.91		0.99	0.92
	30 (762)			1.00			1.00	0.91	0.81	0.76					1.00			1.00	1.00
36 (914)							1.00	0.87	0.82										
> 48 (1219)								0.99	0.92										

Table 62 - Load adjustment factors for 10M rebar in cracked concrete^{1,2,3}



10M cracked concrete	Spacing factor in tension			Edge distance factor in tension			Spacing factor in shear ⁴			Edge distance in shear						Concrete thickness factor in shear ⁵			
										⊥ Toward edge			∥ To and away from edge						
	f_{AN}	f_{RN}	f_{AV}	f_{RV}	f_{RV}	f_{RV}	f_{RV}	f_{RV}	f_{RV}	f_{RV}	f_{RV}	f_{RV}	f_{RV}	f_{RV}	f_{RV}	f_{RV}	f_{RV}	f_{RV}	
Embedment h_{ef} in. (mm)	4-1/2 (115)	7-1/16 (180)	8-7/8 (226)	4-1/2 (115)	7-1/16 (180)	8-7/8 (226)	4-1/2 (115)	7-1/16 (180)	8-8/9 (226)	4-1/2 (115)	7-1/16 (180)	8-7/8 (226)	4-1/2 (115)	7-1/16 (180)	8-7/8 (226)	4-1/2 (115)	7-1/16 (180)	8-7/8 (226)	
Spacing (s) / edge distance (c _e) / concrete thickness (h _c) - in. (mm)	1-3/4 (44)	n/a	n/a	n/a	0.49	0.44	0.42	n/a	n/a	n/a	0.05	0.03	0.03	0.10	0.07	0.05	n/a	n/a	n/a
	2-3/16 (55)	0.58	0.55	0.54	0.52	0.46	0.43	0.53	0.52	0.52	0.07	0.04	0.04	0.14	0.09	0.07	n/a	n/a	n/a
	3 (76)	0.61	0.57	0.56	0.60	0.50	0.47	0.54	0.53	0.53	0.11	0.07	0.06	0.23	0.15	0.12	n/a	n/a	n/a
	4 (102)	0.65	0.59	0.57	0.70	0.56	0.51	0.55	0.54	0.53	0.18	0.11	0.09	0.35	0.23	0.18	n/a	n/a	n/a
	5 (127)	0.68	0.62	0.59	0.80	0.62	0.56	0.57	0.55	0.54	0.25	0.16	0.13	0.49	0.32	0.25	n/a	n/a	n/a
	5-11/16 (145)	0.71	0.63	0.61	0.88	0.66	0.59	0.57	0.56	0.55	0.30	0.19	0.15	0.60	0.39	0.31	0.55	n/a	n/a
	6 (152)	0.72	0.64	0.61	0.91	0.68	0.61	0.58	0.56	0.55	0.32	0.21	0.17	0.65	0.41	0.33	0.56	n/a	n/a
	7 (178)	0.76	0.66	0.63	1.00	0.74	0.65	0.59	0.57	0.56	0.41	0.26	0.21	0.82	0.52	0.42	0.61	n/a	n/a
	8 (203)	0.79	0.69	0.65		0.81	0.70	0.60	0.58	0.57	0.50	0.32	0.25	1.00	0.64	0.51	0.65	n/a	n/a
	8-1/4 (210)	0.80	0.69	0.65		0.83	0.72	0.61	0.58	0.57	0.53	0.34	0.27		0.67	0.53	0.66	0.57	n/a
	9 (229)	0.83	0.71	0.67		0.88	0.76	0.62	0.59	0.58	0.60	0.38	0.30		0.76	0.61	0.69	0.59	n/a
	10-1/16 (256)	0.87	0.74	0.69		0.96	0.81	0.63	0.60	0.58	0.71	0.45	0.36		0.90	0.72	0.73	0.63	0.58
	11 (279)	0.90	0.76	0.71		1.00	0.86	0.64	0.61	0.59	0.81	0.51	0.41		1.00	0.82	0.76	0.65	0.61
	12 (305)	0.94	0.78	0.72			0.92	0.66	0.62	0.60	0.92	0.59	0.47			0.92	0.79	0.68	0.63
	14 (356)	1.00	0.83	0.76			1.00	0.68	0.64	0.62	1.00	0.74	0.59			1.00	0.86	0.74	0.68
	16 (406)		0.88	0.80				0.71	0.66	0.63		0.90	0.72				0.92	0.79	0.73
	18 (457)		0.92	0.84				0.74	0.68	0.65		1.00	0.86				0.97	0.84	0.78
	24 (610)		1.00	0.95				0.81	0.73	0.70			1.00				1.00	0.97	0.90
	30 (762)			1.00				0.89	0.79	0.75								1.00	1.00
36 (914)							0.97	0.85	0.80										
> 48 (1219)							1.00	0.97	0.90										

- Linear interpolation not permitted.
- Shaded area with reduced edge distance is permitted provided the rebar has no installation torque.
- When combining multiple load adjustment factors (e.g. for a four-anchor pattern in a corner with thin concrete member) the design can become very conservative. To optimize the design, use Hilti PROFIS Anchor Design software or perform anchor calculation using design equations from CSA A23.3-14 Annex D.
- Spacing factor reduction in shear, f_{AV} , assumes an influence of a nearby edge. If no edge exists, then $f_{AV} = f_{AN}$.
- Concrete thickness reduction factor in shear, f_{HV} , assumes an influence of a nearby edge. If no edge exists, then $f_{HV} = 1.0$.

HIT-RE 500 V3 Epoxy Adhesive Anchoring System 3.2.4

Table 63 - Load adjustment factors for 15M rebar in uncracked concrete^{1,2,3}



15M uncracked concrete	Spacing factor in tension f_{AN}			Edge distance factor in tension f_{RN}			Spacing factor in shear ⁴ f_{AV}			Edge distance in shear						Concrete thickness factor in shear ⁵ f_{HV}		
										⊥ Toward edge f_{RV}			∥ To and away from edge f_{RV}					
	Embedment h_{ef} in. (mm)	5-11/16 (145)	9-13/16 (250)	12-5/8 (320)	5-11/16 (145)	9-13/16 (250)	12-5/8 (320)	5-11/16 (145)	9-13/16 (250)	12-5/8 (320)	5-11/16 (145)	9-13/16 (250)	12-5/8 (320)	5-11/16 (145)	9-13/16 (250)	12-5/8 (320)	5-11/16 (145)	9-13/16 (250)
1-3/4 (44)	n/a	n/a	n/a	0.24	0.14	0.11	n/a	n/a	n/a	0.04	0.02	0.02	0.08	0.04	0.03	n/a	n/a	n/a
3-1/8 (80)	0.59	0.55	0.54	0.29	0.17	0.13	0.54	0.52	0.52	0.10	0.05	0.04	0.20	0.11	0.08	n/a	n/a	n/a
4 (102)	0.61	0.57	0.55	0.33	0.19	0.14	0.55	0.53	0.53	0.14	0.08	0.06	0.29	0.15	0.12	n/a	n/a	n/a
5 (127)	0.64	0.58	0.57	0.37	0.21	0.16	0.56	0.54	0.53	0.20	0.11	0.08	0.37	0.21	0.16	n/a	n/a	n/a
6 (152)	0.67	0.60	0.58	0.41	0.23	0.18	0.57	0.54	0.54	0.27	0.14	0.11	0.41	0.23	0.18	n/a	n/a	n/a
7 (178)	0.70	0.62	0.59	0.46	0.26	0.20	0.58	0.55	0.54	0.33	0.18	0.14	0.46	0.26	0.20	n/a	n/a	n/a
7-1/4 (184)	0.71	0.62	0.60	0.47	0.26	0.20	0.58	0.55	0.55	0.35	0.18	0.14	0.47	0.26	0.20	0.58	n/a	n/a
8 (203)	0.73	0.64	0.61	0.50	0.28	0.22	0.59	0.56	0.55	0.41	0.21	0.17	0.50	0.28	0.22	0.61	n/a	n/a
9 (229)	0.76	0.65	0.62	0.56	0.31	0.24	0.60	0.57	0.56	0.49	0.26	0.20	0.56	0.31	0.24	0.64	n/a	n/a
10 (254)	0.78	0.67	0.63	0.62	0.35	0.27	0.61	0.57	0.56	0.57	0.30	0.23	0.62	0.35	0.27	0.68	n/a	n/a
11-3/8 (289)	0.82	0.69	0.65	0.71	0.40	0.31	0.63	0.58	0.57	0.69	0.36	0.28	0.71	0.40	0.31	0.72	0.58	n/a
12 (305)	0.84	0.70	0.66	0.74	0.42	0.32	0.64	0.59	0.58	0.75	0.39	0.31	0.74	0.42	0.32	0.74	0.60	n/a
14-1/8 (359)	0.90	0.74	0.69	0.88	0.49	0.38	0.66	0.61	0.59	0.96	0.50	0.39	0.88	0.49	0.38	0.81	0.65	0.60
16 (406)	0.96	0.77	0.71	0.99	0.56	0.43	0.68	0.62	0.60	1.00	0.61	0.47	0.99	0.56	0.43	0.86	0.69	0.64
18 (457)	1.00	0.80	0.74	1.00	0.63	0.48	0.71	0.63	0.61		0.72	0.56	1.00	0.63	0.48	0.91	0.73	0.67
20 (508)		0.84	0.76		0.70	0.54	0.73	0.65	0.63		0.85	0.66		0.70	0.54	0.96	0.77	0.71
22 (559)		0.87	0.79		0.77	0.59	0.75	0.66	0.64		0.98	0.76		0.77	0.59	1.00	0.81	0.75
24 (610)		0.91	0.82		0.83	0.65	0.78	0.68	0.65		1.00	0.87		0.83	0.65		0.85	0.78
30 (762)		1.00	0.90		1.00	0.81	0.84	0.72	0.69			1.00		1.00	0.81		0.95	0.87
36 (914)			0.98			0.97	0.91	0.77	0.73						0.97		1.00	0.95
> 48 (1219)			1.00			1.00	1.00	0.86	0.80						1.00			1.00

3.2.4

Table 64 - Load adjustment factors for 15M rebar in cracked concrete^{1,2,3}



15M cracked concrete	Spacing factor in tension f_{AN}			Edge distance factor in tension f_{RN}			Spacing factor in shear ⁴ f_{AV}			Edge distance in shear						Concrete thickness factor in shear ⁵ f_{HV}		
										⊥ Toward edge f_{RV}			∥ To and away from edge f_{RV}					
	Embedment h_{ef} in. (mm)	5-11/16 (145)	9-13/16 (250)	12-5/8 (320)	5-11/16 (145)	9-13/16 (250)	12-5/8 (320)	5-11/16 (145)	9-13/16 (250)	12-5/8 (320)	5-11/16 (145)	9-13/16 (250)	12-5/8 (320)	5-11/16 (145)	9-13/16 (250)	12-5/8 (320)	5-11/16 (145)	9-13/16 (250)
1-3/4 (44)	n/a	n/a	n/a	0.46	0.41	0.40	n/a	n/a	n/a	0.04	0.02	0.02	0.09	0.04	0.03	n/a	n/a	n/a
3-1/8 (80)	0.59	0.55	0.54	0.55	0.46	0.44	0.54	0.52	0.52	0.10	0.05	0.04	0.21	0.09	0.07	n/a	n/a	n/a
4 (102)	0.61	0.57	0.55	0.61	0.50	0.46	0.55	0.53	0.52	0.15	0.07	0.05	0.29	0.13	0.10	n/a	n/a	n/a
5 (127)	0.64	0.58	0.57	0.68	0.54	0.49	0.56	0.53	0.53	0.21	0.09	0.07	0.41	0.19	0.15	n/a	n/a	n/a
6 (152)	0.67	0.60	0.58	0.76	0.58	0.52	0.57	0.54	0.53	0.27	0.12	0.10	0.54	0.25	0.19	n/a	n/a	n/a
7 (178)	0.70	0.62	0.59	0.84	0.62	0.56	0.58	0.55	0.54	0.34	0.15	0.12	0.68	0.31	0.24	n/a	n/a	n/a
7-1/4 (184)	0.71	0.62	0.60	0.86	0.63	0.56	0.58	0.55	0.54	0.36	0.16	0.13	0.72	0.33	0.25	0.58	n/a	n/a
8 (203)	0.73	0.64	0.61	0.93	0.66	0.59	0.59	0.55	0.55	0.42	0.19	0.15	0.83	0.38	0.30	0.61	n/a	n/a
9 (229)	0.76	0.65	0.62	1.00	0.71	0.62	0.60	0.56	0.55	0.50	0.23	0.18	0.99	0.45	0.35	0.65	n/a	n/a
10 (254)	0.78	0.67	0.63		0.76	0.66	0.62	0.57	0.56	0.58	0.26	0.21	1.00	0.53	0.41	0.68	n/a	n/a
11-3/8 (289)	0.82	0.69	0.65		0.82	0.71	0.63	0.58	0.57	0.71	0.32	0.25		0.64	0.50	0.73	0.56	n/a
12 (305)	0.84	0.70	0.66		0.86	0.73	0.64	0.58	0.57	0.77	0.35	0.27		0.69	0.54	0.75	0.57	n/a
14-1/8 (359)	0.90	0.74	0.69		0.97	0.81	0.66	0.60	0.58	0.98	0.44	0.35		0.89	0.69	0.81	0.62	0.57
16 (406)	0.96	0.77	0.71		1.00	0.88	0.69	0.61	0.59	1.00	0.53	0.42		1.00	0.84	0.86	0.66	0.61
18 (457)	1.00	0.80	0.74			0.96	0.71	0.62	0.60		0.64	0.50			0.96	0.91	0.70	0.65
20 (508)		0.84	0.76			1.00	0.73	0.64	0.62		0.75	0.58			1.00	0.96	0.74	0.68
22 (559)		0.87	0.79				0.76	0.65	0.63		0.86	0.67				1.00	0.78	0.72
24 (610)		0.91	0.82				0.78	0.66	0.64		0.98	0.77					0.81	0.75
30 (762)		1.00	0.90				0.85	0.71	0.67		1.00	1.00					0.91	0.84
36 (914)			0.98				0.92	0.75	0.71								0.99	0.92
> 48 (1219)			1.00				1.00	0.83	0.78								1.00	1.00

- Linear interpolation not permitted.
- Shaded area with reduced edge distance is permitted provided the rebar has no installation torque.
- When combining multiple load adjustment factors (e.g. for a four-anchor pattern in a corner with thin concrete member) the design can become very conservative. To optimize the design, use Hilti PROFIS Anchor Design software or perform anchor calculation using design equations from CSA A23.3-14 Annex D.
- Spacing factor reduction in shear, f_{AV} , assumes an influence of a nearby edge. If no edge exists, then $f_{AV} = f_{AN}$.
- Concrete thickness reduction factor in shear, f_{HV} , assumes an influence of a nearby edge. If no edge exists, then $f_{HV} = 1.0$.

3.2.4 HIT-RE 500 V3 Epoxy Adhesive Anchoring System

Table 65 - Load adjustment factors for 20M rebar in uncracked concrete^{1,2,3}



20M uncracked concrete	Spacing factor in tension f_{AN}			Edge distance factor in tension f_{RN}			Spacing factor in shear ⁴ f_{AV}			Edge distance in shear						Concrete thickness factor in shear ⁵ f_{HV}			
										⊥ Toward edge f_{RV}			∥ To and away from edge f_{RV}						
	Embedment h_{ef} in. (mm)	7-7/8 (200)	14 (355)	15-3/8 (390)	7-7/8 (200)	14 (355)	15-3/8 (390)	7-7/8 (200)	14 (355)	15-3/8 (390)	7-7/8 (200)	14 (355)	15-3/8 (390)	7-7/8 (200)	14 (355)	15-3/8 (390)	7-7/8 (200)	14 (355)	15-3/8 (390)
Spacing (s) / edge distance (c _e) / concrete thickness (h _c) - in. (mm)	1-3/4 (44)	n/a	n/a	n/a	0.21	0.11	0.10	n/a	n/a	n/a	0.03	0.01	0.01	0.06	0.03	0.02	n/a	n/a	n/a
	3-7/8 (98)	0.58	0.55	0.54	0.26	0.14	0.13	0.53	0.52	0.52	0.09	0.04	0.04	0.18	0.09	0.08	n/a	n/a	n/a
	4 (102)	0.58	0.55	0.54	0.27	0.15	0.13	0.53	0.52	0.52	0.10	0.05	0.04	0.19	0.09	0.09	n/a	n/a	n/a
	5 (127)	0.61	0.56	0.55	0.30	0.16	0.15	0.54	0.53	0.53	0.13	0.07	0.06	0.27	0.13	0.12	n/a	n/a	n/a
	6 (152)	0.63	0.57	0.57	0.33	0.18	0.16	0.55	0.53	0.53	0.17	0.09	0.08	0.33	0.17	0.16	n/a	n/a	n/a
	7 (178)	0.65	0.58	0.58	0.36	0.19	0.18	0.56	0.54	0.54	0.22	0.11	0.10	0.36	0.19	0.18	n/a	n/a	n/a
	8 (203)	0.67	0.60	0.59	0.39	0.21	0.19	0.57	0.54	0.54	0.27	0.13	0.12	0.39	0.21	0.19	n/a	n/a	n/a
	9 (229)	0.69	0.61	0.60	0.42	0.23	0.21	0.58	0.55	0.55	0.32	0.16	0.15	0.42	0.23	0.21	n/a	n/a	n/a
	10 (254)	0.71	0.62	0.61	0.46	0.25	0.23	0.59	0.55	0.55	0.38	0.19	0.17	0.46	0.25	0.23	0.59	n/a	n/a
	11 (279)	0.73	0.63	0.62	0.50	0.27	0.25	0.60	0.56	0.56	0.43	0.22	0.20	0.50	0.27	0.25	0.62	n/a	n/a
	12 (305)	0.75	0.64	0.63	0.54	0.30	0.27	0.60	0.57	0.56	0.49	0.25	0.22	0.54	0.30	0.27	0.65	n/a	n/a
	14 (356)	0.80	0.67	0.65	0.63	0.34	0.31	0.62	0.58	0.57	0.62	0.31	0.28	0.63	0.34	0.31	0.70	n/a	n/a
	16 (406)	0.84	0.69	0.67	0.72	0.39	0.36	0.64	0.59	0.58	0.76	0.38	0.34	0.72	0.39	0.36	0.74	0.59	n/a
	18 (457)	0.88	0.71	0.70	0.81	0.44	0.40	0.66	0.60	0.59	0.91	0.45	0.41	0.81	0.44	0.40	0.79	0.63	0.61
	20 (508)	0.92	0.74	0.72	0.90	0.49	0.45	0.67	0.61	0.60	1.00	0.53	0.48	0.90	0.49	0.45	0.83	0.66	0.64
	22 (559)	0.97	0.76	0.74	0.99	0.54	0.49	0.69	0.62	0.61		0.61	0.56	0.99	0.54	0.49	0.87	0.69	0.67
	24 (610)	1.00	0.79	0.76	1.00	0.59	0.54	0.71	0.63	0.62		0.70	0.63	1.00	0.59	0.54	0.91	0.72	0.70
	26 (660)		0.81	0.78		0.64	0.58	0.73	0.64	0.63		0.79	0.72		0.64	0.58	0.95	0.75	0.73
	28 (711)		0.83	0.80		0.69	0.62	0.74	0.65	0.64		0.88	0.80		0.69	0.62	0.99	0.78	0.76
30 (762)		0.86	0.83		0.74	0.67	0.76	0.66	0.65		0.97	0.89		0.74	0.67	1.00	0.81	0.78	
36 (914)		0.93	0.89		0.89	0.80	0.81	0.70	0.68		1.00	1.00		0.89	0.80		0.89	0.86	
> 48 (1219)		1.00	1.00		1.00	1.00	0.92	0.76	0.75					1.00	1.00		1.00	0.99	

Table 66 - Load adjustment factors for 20M rebar in cracked concrete^{1,2,3}



20M cracked concrete	Spacing factor in tension f_{AN}			Edge distance factor in tension f_{RN}			Spacing factor in shear ⁴ f_{AV}			Edge distance in shear						Concrete thickness factor in shear ⁵ f_{HV}			
										⊥ Toward edge f_{RV}			∥ To and away from edge f_{RV}						
	Embedment h_{ef} in. (mm)	7-7/8 (200)	14 (355)	15-3/8 (390)	7-7/8 (200)	14 (355)	15-3/8 (390)	7-7/8 (200)	14 (355)	15-3/8 (390)	7-7/8 (200)	14 (355)	15-3/8 (390)	7-7/8 (200)	14 (355)	15-3/8 (390)	7-7/8 (200)	14 (355)	15-3/8 (390)
Spacing (s) / edge distance (c _e) / concrete thickness (h _c) - in. (mm)	1-3/4 (44)	n/a	n/a	n/a	0.43	0.39	0.39	n/a	n/a	n/a	0.03	0.01	0.01	0.06	0.02	0.02	n/a	n/a	n/a
	3-7/8 (98)	0.58	0.55	0.54	0.53	0.45	0.44	0.53	0.52	0.52	0.09	0.04	0.04	0.18	0.08	0.07	n/a	n/a	n/a
	4 (102)	0.58	0.55	0.54	0.54	0.45	0.44	0.54	0.52	0.52	0.10	0.04	0.04	0.19	0.08	0.07	n/a	n/a	n/a
	5 (127)	0.61	0.56	0.55	0.59	0.48	0.47	0.54	0.52	0.52	0.14	0.06	0.05	0.27	0.11	0.10	n/a	n/a	n/a
	6 (152)	0.63	0.57	0.57	0.64	0.51	0.49	0.55	0.53	0.53	0.18	0.08	0.07	0.36	0.15	0.14	n/a	n/a	n/a
	7 (178)	0.65	0.58	0.58	0.70	0.53	0.52	0.56	0.53	0.53	0.22	0.09	0.09	0.45	0.19	0.17	n/a	n/a	n/a
	8 (203)	0.67	0.60	0.59	0.76	0.56	0.54	0.57	0.54	0.54	0.27	0.12	0.10	0.55	0.23	0.21	n/a	n/a	n/a
	9 (229)	0.69	0.61	0.60	0.82	0.59	0.57	0.58	0.54	0.54	0.33	0.14	0.12	0.65	0.28	0.25	n/a	n/a	n/a
	10 (254)	0.71	0.62	0.61	0.88	0.62	0.60	0.59	0.55	0.55	0.38	0.16	0.15	0.77	0.32	0.29	0.59	n/a	n/a
	11 (279)	0.73	0.63	0.62	0.95	0.65	0.62	0.60	0.55	0.55	0.44	0.19	0.17	0.88	0.37	0.34	0.62	n/a	n/a
	12 (305)	0.75	0.64	0.63	1.00	0.69	0.65	0.61	0.56	0.56	0.50	0.21	0.19	1.00	0.43	0.38	0.65	n/a	n/a
	14 (356)	0.80	0.67	0.65		0.75	0.71	0.62	0.57	0.56	0.64	0.27	0.24		0.54	0.48	0.70	n/a	n/a
	16 (406)	0.84	0.69	0.67		0.82	0.77	0.64	0.58	0.57	0.77	0.33	0.30		0.66	0.59	0.75	0.56	n/a
	18 (457)	0.88	0.71	0.70		0.89	0.83	0.66	0.59	0.58	0.93	0.39	0.35		0.78	0.71	0.80	0.60	0.58
	20 (508)	0.92	0.74	0.72		0.96	0.90	0.68	0.60	0.59	1.00	0.46	0.41		0.92	0.83	0.84	0.63	0.61
	22 (559)	0.97	0.76	0.74		1.00	0.96	0.69	0.61	0.60		0.53	0.48		1.00	0.95	0.88	0.66	0.64
	24 (610)	1.00	0.79	0.76			1.00	0.71	0.62	0.61		0.60	0.54			1.00	0.92	0.69	0.67
	26 (660)		0.81	0.78				0.73	0.63	0.62		0.68	0.61				0.96	0.72	0.69
	28 (711)		0.83	0.80				0.75	0.64	0.63		0.76	0.68				0.99	0.74	0.72
30 (762)		0.86	0.83				0.76	0.65	0.64		0.84	0.76				1.00	0.77	0.74	
36 (914)		0.93	0.89				0.82	0.68	0.67		1.00	1.00					0.84	0.82	
> 48 (1219)		1.00	1.00				0.92	0.74	0.72								0.98	0.94	

- 1 Linear interpolation not permitted.
- 2 Shaded area with reduced edge distance is permitted provided the rebar has no installation torque.
- 3 When combining multiple load adjustment factors (e.g. for a four-anchor pattern in a corner with thin concrete member) the design can become very conservative. To optimize the design, use Hilti PROFIS Anchor Design software or perform anchor calculation using design equations from CSA A23.3-14 Annex D.
- 4 Spacing factor reduction in shear, f_{AV} , assumes an influence of a nearby edge. If no edge exists, then $f_{AV} = f_{AN}$.
- 5 Concrete thickness reduction factor in shear, f_{HV} , assumes an influence of a nearby edge. If no edge exists, then $f_{HV} = 1.0$.

HIT-RE 500 V3 Epoxy Adhesive Anchoring System 3.2.4

Table 67 - Load adjustment factors for 25M rebar in uncracked concrete^{1,2,3}

25M uncracked concrete	Spacing factor in tension			Edge distance factor in tension			Spacing factor in shear ⁴			Edge distance in shear						Concrete thickness factor in shear ⁵		
										⊥ Toward edge			To and away from edge					
	f_{AN}			f_{RN}			f_{AV}			f_{RV}			f_{RV}			f_{HV}		
Embedment h_{ef}	9-1/16	15-15/16	19-13/16	9-1/16	15-15/16	19-13/16	9-1/16	15-15/16	19-13/16	9-1/16	15-15/16	19-13/16	9-1/16	15-15/16	19-13/16	9-1/16	15-15/16	19-13/16
in. (mm)	(230)	(405)	(504)	(230)	(405)	(504)	(230)	(405)	(504)	(230)	(405)	(504)	(230)	(405)	(504)	(230)	(405)	(504)
1-3/4 (44)	n/a	n/a	n/a	0.24	0.12	0.10	n/a	n/a	n/a	0.02	0.01	0.01	0.04	0.02	0.02	n/a	n/a	n/a
5 (127)	0.59	0.55	0.54	0.32	0.16	0.13	0.54	0.52	0.52	0.11	0.05	0.04	0.22	0.09	0.07	n/a	n/a	n/a
6 (152)	0.61	0.56	0.55	0.34	0.18	0.14	0.55	0.53	0.52	0.14	0.06	0.05	0.28	0.12	0.10	n/a	n/a	n/a
7 (178)	0.63	0.57	0.56	0.37	0.19	0.15	0.55	0.53	0.53	0.18	0.08	0.06	0.36	0.15	0.12	n/a	n/a	n/a
8 (203)	0.65	0.58	0.57	0.40	0.21	0.16	0.56	0.53	0.53	0.22	0.09	0.07	0.40	0.19	0.15	n/a	n/a	n/a
9 (229)	0.67	0.59	0.58	0.43	0.22	0.18	0.57	0.54	0.53	0.26	0.11	0.09	0.43	0.22	0.18	n/a	n/a	n/a
10 (254)	0.68	0.60	0.58	0.46	0.24	0.19	0.58	0.54	0.54	0.30	0.13	0.10	0.46	0.24	0.19	n/a	n/a	n/a
11-9/16 (294)	0.71	0.62	0.60	0.51	0.26	0.21	0.59	0.55	0.54	0.38	0.16	0.13	0.51	0.26	0.21	0.59	n/a	n/a
12 (305)	0.72	0.63	0.60	0.52	0.27	0.21	0.59	0.55	0.54	0.40	0.17	0.14	0.52	0.27	0.21	0.60	n/a	n/a
14 (356)	0.76	0.65	0.62	0.59	0.31	0.24	0.61	0.56	0.55	0.50	0.22	0.17	0.59	0.31	0.24	0.65	n/a	n/a
16 (406)	0.79	0.67	0.63	0.68	0.35	0.28	0.62	0.57	0.56	0.62	0.26	0.21	0.68	0.35	0.28	0.69	n/a	n/a
18 (457)	0.83	0.69	0.65	0.76	0.39	0.31	0.64	0.58	0.57	0.74	0.31	0.25	0.76	0.39	0.31	0.74	n/a	n/a
18-7/16 (469)	0.84	0.69	0.66	0.78	0.40	0.32	0.64	0.58	0.57	0.76	0.33	0.26	0.78	0.40	0.32	0.75	0.56	n/a
20 (508)	0.87	0.71	0.67	0.85	0.44	0.35	0.65	0.59	0.57	0.86	0.37	0.30	0.85	0.44	0.35	0.78	0.59	n/a
22-3/8 (568)	0.91	0.73	0.69	0.95	0.49	0.39	0.67	0.60	0.58	1.00	0.44	0.35	0.95	0.49	0.39	0.82	0.62	0.58
24 (610)	0.94	0.75	0.70	1.00	0.52	0.42	0.68	0.60	0.59		0.48	0.39	1.00	0.52	0.42	0.85	0.64	0.60
26 (660)	0.98	0.77	0.72		0.57	0.45	0.70	0.61	0.60		0.55	0.44		0.57	0.45	0.89	0.67	0.62
28 (711)	1.00	0.79	0.74		0.61	0.49	0.71	0.62	0.60		0.61	0.49		0.61	0.49	0.92	0.69	0.64
30 (762)		0.81	0.75		0.66	0.52	0.73	0.63	0.61		0.68	0.54		0.66	0.52	0.95	0.72	0.67
36 (914)		0.88	0.80		0.79	0.63	0.77	0.65	0.63		0.89	0.71		0.79	0.63	1.00	0.79	0.73
> 48 (1219)		1.00	0.90		1.00	0.84	0.86	0.71	0.68		1.00	1.00		1.00	0.84		0.91	0.84

3.2.4

Table 68 - Load adjustment factors for 25M rebar in cracked concrete^{1,2,3}

25M cracked concrete	Spacing factor in tension			Edge distance factor in tension			Spacing factor in shear ⁴			Edge distance in shear						Concrete thickness factor in shear ⁵		
										⊥ Toward edge			To and away from edge					
	f_{AN}			f_{RN}			f_{AV}			f_{RV}			f_{RV}			f_{HV}		
Embedment h_{ef}	9-1/16	15-15/16	19-13/16	9-1/16	15-15/16	19-13/16	9-1/16	15-15/16	19-13/16	9-1/16	15-15/16	19-13/16	9-1/16	15-15/16	19-13/16	9-1/16	15-15/16	19-13/16
in. (mm)	(230)	(405)	(504)	(230)	(405)	(504)	(230)	(405)	(504)	(230)	(405)	(504)	(230)	(405)	(504)	(230)	(405)	(504)
1-3/4 (44)	n/a	n/a	n/a	0.42	0.39	0.38	n/a	n/a	n/a	0.02	0.01	0.01	0.05	0.02	0.01	n/a	n/a	n/a
5 (127)	0.59	0.55	0.54	0.55	0.46	0.44	0.54	0.52	0.52	0.11	0.05	0.03	0.22	0.09	0.07	n/a	n/a	n/a
6 (152)	0.61	0.56	0.55	0.60	0.48	0.46	0.55	0.53	0.52	0.14	0.06	0.04	0.29	0.12	0.09	n/a	n/a	n/a
7 (178)	0.63	0.57	0.56	0.65	0.51	0.48	0.55	0.53	0.52	0.18	0.08	0.06	0.36	0.16	0.11	n/a	n/a	n/a
8 (203)	0.65	0.58	0.57	0.70	0.53	0.50	0.56	0.53	0.53	0.22	0.10	0.07	0.44	0.19	0.14	n/a	n/a	n/a
9 (229)	0.67	0.59	0.58	0.75	0.56	0.51	0.57	0.54	0.53	0.27	0.11	0.08	0.53	0.23	0.16	n/a	n/a	n/a
10 (254)	0.68	0.60	0.58	0.80	0.59	0.53	0.58	0.54	0.53	0.31	0.13	0.10	0.62	0.27	0.19	n/a	n/a	n/a
11-9/16 (294)	0.71	0.62	0.60	0.89	0.63	0.57	0.59	0.55	0.54	0.39	0.17	0.12	0.77	0.33	0.24	0.60	n/a	n/a
12 (305)	0.72	0.63	0.60	0.91	0.64	0.58	0.59	0.55	0.54	0.41	0.17	0.13	0.82	0.35	0.25	0.61	n/a	n/a
14 (356)	0.76	0.65	0.62	1.00	0.69	0.62	0.61	0.56	0.55	0.51	0.22	0.16	1.00	0.44	0.32	0.65	n/a	n/a
16 (406)	0.79	0.67	0.63		0.75	0.66	0.62	0.57	0.56	0.63	0.27	0.19		0.54	0.39	0.70	n/a	n/a
18 (457)	0.83	0.69	0.65		0.81	0.71	0.64	0.58	0.56	0.75	0.32	0.23		0.64	0.46	0.74	n/a	n/a
18-7/16 (469)	0.84	0.69	0.66		0.83	0.72	0.64	0.58	0.56	0.78	0.33	0.24		0.67	0.48	0.75	0.57	n/a
20 (508)	0.87	0.71	0.67		0.87	0.75	0.65	0.59	0.57	0.88	0.38	0.27		0.75	0.54	0.78	0.59	n/a
22-3/8 (568)	0.91	0.73	0.69		0.95	0.81	0.67	0.60	0.58	1.00	0.44	0.32		0.89	0.64	0.83	0.62	0.56
24 (610)	0.94	0.75	0.70		1.00	0.85	0.68	0.60	0.58		0.49	0.36		0.99	0.71	0.86	0.65	0.58
26 (660)	0.98	0.77	0.72			0.90	0.70	0.61	0.59		0.56	0.40		1.00	0.80	0.89	0.67	0.60
28 (711)	1.00	0.79	0.74			0.95	0.71	0.62	0.60		0.62	0.45			0.90	0.93	0.70	0.63
30 (762)		0.81	0.75			1.00	0.73	0.63	0.60		0.69	0.50			1.00	0.96	0.72	0.65
36 (914)		0.88	0.80				0.78	0.66	0.63		0.91	0.65				1.00	0.79	0.71
> 48 (1219)		1.00	0.90				0.87	0.71	0.67		1.00	1.00					0.91	0.82

1 Linear interpolation not permitted.

2 Shaded area with reduced edge distance is permitted provided the rebar has no installation torque.

3 When combining multiple load adjustment factors (e.g. for a four-anchor pattern in a corner with thin concrete member) the design can become very conservative. To optimize the design, use Hilti PROFIS Anchor Design software or perform anchor calculation using design equations from CSA A23.3-14 Annex D.

 4 Spacing factor reduction in shear, f_{AV} , assumes an influence of a nearby edge. If no edge exists, then $f_{AV} = f_{AN}$.

 5 Concrete thickness reduction factor in shear, f_{HV} , assumes an influence of a nearby edge. If no edge exists, then $f_{HV} = 1.0$.

3.2.4 HIT-RE 500 V3 Epoxy Adhesive Anchoring System

Table 69 - Load adjustment factors for 30M rebar in uncracked concrete^{1,2,3}



30M uncracked concrete	Spacing factor in tension			Edge distance factor in tension			Spacing factor in shear ⁴			Edge distance in shear						Concrete thickness factor in shear ⁵			
										⊥ Toward edge			∥ To and away from edge						
	f_{AN}	f_{RN}	f_{AV}	f_{RV}	f_{RV}	f_{RV}	f_{RV}	f_{RV}	f_{RV}	f_{RV}	f_{RV}	f_{RV}	f_{RV}	f_{RV}	f_{RV}	f_{RV}	f_{RV}	f_{RV}	f_{RV}
Embedment h_{ef} in. (mm)	10-1/4 (260)	17-15/16 (455)	23-9/16 (598)	10-1/4 (260)	17-15/16 (455)	23-9/16 (598)	10-1/4 (260)	17-15/16 (455)	23-9/16 (598)	10-1/4 (260)	17-15/16 (455)	23-9/16 (598)	10-1/4 (260)	17-15/16 (455)	23-9/16 (598)	10-1/4 (260)	17-15/16 (455)	23-9/16 (598)	
Spacing (s) / edge distance (c _e) / concrete thickness (h _c) - in. (mm)	1-3/4 (44)	n/a	n/a	n/a	0.25	0.13	0.10	n/a	n/a	n/a	0.02	0.01	0.01	0.04	0.02	0.01	n/a	n/a	n/a
	5-7/8 (150)	0.59	0.55	0.54	0.34	0.17	0.13	0.54	0.52	0.52	0.12	0.05	0.03	0.23	0.10	0.07	n/a	n/a	n/a
	6 (152)	0.59	0.56	0.54	0.34	0.18	0.13	0.54	0.52	0.52	0.12	0.05	0.04	0.24	0.10	0.07	n/a	n/a	n/a
	7 (178)	0.61	0.57	0.55	0.37	0.19	0.14	0.55	0.53	0.52	0.15	0.06	0.04	0.30	0.13	0.09	n/a	n/a	n/a
	8 (203)	0.63	0.57	0.56	0.39	0.20	0.15	0.55	0.53	0.52	0.18	0.08	0.05	0.36	0.16	0.11	n/a	n/a	n/a
	9 (229)	0.64	0.58	0.56	0.42	0.21	0.16	0.56	0.53	0.53	0.22	0.09	0.07	0.42	0.19	0.13	n/a	n/a	n/a
	10 (254)	0.66	0.59	0.57	0.45	0.23	0.17	0.57	0.54	0.53	0.25	0.11	0.08	0.45	0.22	0.15	n/a	n/a	n/a
	11 (279)	0.67	0.60	0.58	0.47	0.24	0.18	0.57	0.54	0.53	0.29	0.13	0.09	0.47	0.24	0.18	n/a	n/a	n/a
	12 (305)	0.69	0.61	0.58	0.50	0.25	0.19	0.58	0.55	0.54	0.33	0.14	0.10	0.50	0.25	0.19	n/a	n/a	n/a
	13-1/4 (337)	0.71	0.62	0.59	0.54	0.27	0.21	0.59	0.55	0.54	0.39	0.17	0.12	0.54	0.27	0.21	0.60	n/a	n/a
	14 (356)	0.72	0.63	0.60	0.56	0.28	0.21	0.59	0.55	0.54	0.42	0.18	0.13	0.56	0.28	0.21	0.61	n/a	n/a
	16 (406)	0.75	0.65	0.61	0.63	0.32	0.24	0.61	0.56	0.55	0.51	0.22	0.15	0.63	0.32	0.24	0.65	n/a	n/a
	18 (457)	0.78	0.67	0.63	0.71	0.35	0.27	0.62	0.57	0.55	0.61	0.26	0.18	0.71	0.35	0.27	0.69	n/a	n/a
	20 (508)	0.81	0.69	0.64	0.79	0.39	0.30	0.63	0.58	0.56	0.72	0.31	0.22	0.79	0.39	0.30	0.73	n/a	n/a
	20-7/8 (531)	0.83	0.69	0.65	0.82	0.41	0.31	0.64	0.58	0.56	0.77	0.33	0.23	0.82	0.41	0.31	0.75	n/a	n/a
	22 (559)	0.85	0.70	0.66	0.87	0.43	0.33	0.65	0.58	0.57	0.83	0.36	0.25	0.87	0.43	0.33	0.77	0.58	n/a
	24 (610)	0.88	0.72	0.67	0.94	0.47	0.36	0.66	0.59	0.57	0.94	0.41	0.28	0.94	0.47	0.36	0.80	0.61	n/a
	26-9/16 (675)	0.92	0.75	0.69	1.00	0.52	0.39	0.68	0.60	0.58	1.00	0.47	0.33	1.00	0.52	0.39	0.84	0.64	0.56
	28 (711)	0.94	0.76	0.70		0.55	0.42	0.69	0.61	0.58		0.51	0.36		0.55	0.42	0.86	0.65	0.58
30 (762)	0.97	0.78	0.71		0.59	0.44	0.70	0.61	0.59		0.57	0.40		0.59	0.44	0.89	0.68	0.60	
36 (914)	1.00	0.83	0.75		0.71	0.53	0.74	0.64	0.61		0.75	0.52		0.71	0.53	0.98	0.74	0.66	
> 48 (1219)		0.95	0.84		0.95	0.71	0.82	0.68	0.64		1.00	0.80		0.95	0.71	1.00	0.86	0.76	

Table 70 - Load adjustment factors for 30M rebar in cracked concrete^{1,2,3}



30M cracked concrete	Spacing factor in tension			Edge distance factor in tension			Spacing factor in shear ⁴			Edge distance in shear						Concrete thickness factor in shear ⁵			
										⊥ Toward edge			∥ To and away from edge						
	f_{AN}	f_{RN}	f_{AV}	f_{RV}	f_{RV}	f_{RV}	f_{RV}	f_{RV}	f_{RV}	f_{RV}	f_{RV}	f_{RV}	f_{RV}	f_{RV}	f_{RV}	f_{RV}	f_{RV}	f_{RV}	f_{RV}
Embedment h_{ef} in. (mm)	10-1/4 (260)	17-15/16 (455)	23-9/16 (598)	10-1/4 (260)	17-15/16 (455)	23-9/16 (598)	10-1/4 (260)	17-15/16 (455)	23-9/16 (598)	10-1/4 (260)	17-15/16 (455)	23-9/16 (598)	10-1/4 (260)	17-15/16 (455)	23-9/16 (598)	10-1/4 (260)	17-15/16 (455)	23-9/16 (598)	
Spacing (s) / edge distance (c _e) / concrete thickness (h _c) - in. (mm)	1-3/4 (44)	n/a	n/a	n/a	0.41	0.38	0.38	n/a	n/a	n/a	0.02	0.01	0.01	0.04	0.02	0.01	n/a	n/a	n/a
	5-7/8 (150)	0.59	0.55	0.54	0.56	0.47	0.44	0.54	0.52	0.52	0.12	0.05	0.03	0.23	0.10	0.07	n/a	n/a	n/a
	6 (152)	0.59	0.56	0.54	0.56	0.47	0.44	0.54	0.52	0.52	0.12	0.05	0.03	0.24	0.10	0.07	n/a	n/a	n/a
	7 (178)	0.61	0.57	0.55	0.60	0.49	0.46	0.55	0.53	0.52	0.15	0.07	0.04	0.30	0.13	0.09	n/a	n/a	n/a
	8 (203)	0.63	0.57	0.56	0.64	0.51	0.47	0.55	0.53	0.52	0.19	0.08	0.05	0.37	0.16	0.11	n/a	n/a	n/a
	9 (229)	0.64	0.58	0.56	0.68	0.53	0.49	0.56	0.53	0.53	0.22	0.10	0.06	0.44	0.19	0.13	n/a	n/a	n/a
	10 (254)	0.66	0.59	0.57	0.72	0.56	0.50	0.57	0.54	0.53	0.26	0.11	0.07	0.52	0.22	0.15	n/a	n/a	n/a
	11 (279)	0.67	0.60	0.58	0.77	0.58	0.52	0.57	0.54	0.53	0.30	0.13	0.09	0.60	0.26	0.17	n/a	n/a	n/a
	12 (305)	0.69	0.61	0.58	0.81	0.60	0.54	0.58	0.55	0.54	0.34	0.15	0.10	0.68	0.29	0.19	n/a	n/a	n/a
	13-1/4 (337)	0.71	0.62	0.59	0.87	0.63	0.56	0.59	0.55	0.54	0.40	0.17	0.11	0.79	0.34	0.23	0.60	n/a	n/a
	14 (356)	0.72	0.63	0.60	0.91	0.65	0.57	0.59	0.55	0.54	0.43	0.19	0.12	0.86	0.37	0.25	0.62	n/a	n/a
	16 (406)	0.75	0.65	0.61	1.00	0.70	0.61	0.61	0.56	0.55	0.52	0.23	0.15	1.00	0.45	0.30	0.66	n/a	n/a
	18 (457)	0.78	0.67	0.63		0.75	0.64	0.62	0.57	0.55	0.62	0.27	0.18		0.54	0.36	0.70	n/a	n/a
	20 (508)	0.81	0.69	0.64		0.81	0.68	0.64	0.58	0.56	0.73	0.32	0.21		0.63	0.42	0.74	n/a	n/a
	20-7/8 (531)	0.83	0.69	0.65		0.83	0.70	0.64	0.58	0.56	0.78	0.34	0.22		0.68	0.45	0.75	n/a	n/a
	22 (559)	0.85	0.70	0.66		0.86	0.72	0.65	0.59	0.56	0.84	0.36	0.24		0.73	0.48	0.77	0.58	n/a
	24 (610)	0.88	0.72	0.67		0.92	0.76	0.66	0.59	0.57	0.96	0.42	0.28		0.83	0.55	0.81	0.61	n/a
	26-9/16 (675)	0.92	0.75	0.69		0.99	0.81	0.68	0.60	0.58	1.00	0.48	0.32		0.97	0.64	0.85	0.64	0.56
	28 (711)	0.94	0.76	0.70		1.00	0.84	0.69	0.61	0.58		0.52	0.35		1.00	0.69	0.87	0.66	0.57
30 (762)	0.97	0.78	0.71		0.88	0.70	0.62	0.59	0.59		0.58	0.39		0.77	0.90	0.68	0.59		
36 (914)	1.00	0.83	0.75		1.00	0.74	0.64	0.61	0.61		0.76	0.51		1.00	0.99	0.75	0.65		
> 48 (1219)		0.95	0.84				0.82	0.69	0.64		1.00	0.78				1.00	0.86	0.75	

- Linear interpolation not permitted.
- Shaded area with reduced edge distance is permitted provided the rebar has no installation torque.
- When combining multiple load adjustment factors (e.g. for a four-anchor pattern in a corner with thin concrete member) the design can become very conservative. To optimize the design, use Hilti PROFIS Anchor Design software or perform anchor calculation using design equations from CSA A23.3-14 Annex D.
- Spacing factor reduction in shear, f_{AV} , assumes an influence of a nearby edge. If no edge exists, then $f_{AV} = f_{AN}$.
- Concrete thickness reduction factor in shear, f_{HV} , assumes an influence of a nearby edge. If no edge exists, then $f_{HV} = 1.0$.

HIT-RE 500 V3 Epoxy Adhesive Anchoring System 3.2.4

Table 71 - Hilti HIT-RE 500 V3 design information with Hilti HAS/HIT-V threaded rods in hammer drilled holes in accordance with CSA A23.3-14 Annex D^{1,8}



Design parameter	Symbol	Units	Nominal rod diameter (in.)							Ref	
			3/8	1/2	5/8	3/4	7/8	1	1-1/4		
Nominal anchor diameter	d_a	mm	9.5	12.7	15.9	19.1	22.2	25.4	31.8	A23.3-14	
Effective minimum embedment ²	$h_{ef,min}$	mm	60	70	79	89	89	102	127		
Effective maximum embedment ²	$h_{ef,max}$	mm	191	254	318	381	445	508	635		
Min. concrete thickness ²	h_{min}	mm	$h_{ef} + 30$								
Critical edge distance	c_{ac}	-	see ESR-3814, section 4.1.10								
Minimum edge distance	c_{min}^3	mm	48	64	79	95	111	127	159		
Minimum anchor spacing	s_{min}	mm	48	64	79	95	111	127	159		
Coeff. for factored conc. breakout resistance, uncracked concrete	$k_{c,unscr}^4$	-	10							D.6.2.2	
Coeff. for factored conc. breakout resistance, cracked concrete	$k_{c,scr}^4$	-	7							D.6.2.2	
Concrete material resistance factor	ϕ_c	-	0.65							8.4.2	
Resistance modification factor for tension and shear, concrete failure modes, Condition B ⁵	R_{conc}	-	1.00							D.5.3(c)	
Dry and water saturated concrete											
Temp. range A ⁶	Characteristic bond stress in cracked concrete ^{6,7}	τ_{cr}	psi (MPa)	1,280 (8.8)	1,270 (8.8)	1,260 (8.7)	1,250 (8.6)	1,240 (8.6)	1,240 (8.6)	1,180 (8.1)	D.6.5.2
	Characteristic bond stress in uncracked concrete ^{6,7}	τ_{unscr}	psi (MPa)	2,380 (16.4)	2,300 (15.9)	2,210 (15.2)	2,130 (14.7)	2,040 (14.1)	1,960 (13.5)	1,790 (12.3)	D.6.5.2
Temp. range B ⁶	Characteristic bond stress in cracked concrete ^{6,7}	τ_{cr}	psi (MPa)	880 (6.1)	870 (6.0)	870 (6.0)	860 (5.9)	860 (5.9)	850 (5.9)	810 (5.6)	D.6.5.2
	Characteristic bond stress in uncracked concrete ^{6,7}	τ_{unscr}	psi (MPa)	1,640 (11.3)	1,590 (11.0)	1,530 (10.6)	1,470 (10.1)	1,410 (9.7)	1,350 (9.3)	1,240 (8.6)	D.6.5.2
Anchor category, dry concrete		-	-	1	1	1	1	1	1	1	
Resistance modification factor		R_{dry}	-	1.00	1.00	1.00	1.00	1.00	1.00	1.00	
Water-filled hole											
Temp. range A ⁶	Characteristic bond stress in cracked concrete ^{6,7}	τ_{cr}	psi (MPa)	940 (6.5)	940 (6.5)	940 (6.5)	940 (6.5)	940 (6.5)	950 (6.6)	920 (6.3)	D.6.5.2
	Characteristic bond stress in uncracked concrete ^{6,7}	τ_{unscr}	psi (MPa)	1,760 (12.1)	1,700 (11.7)	1,660 (11.4)	1,600 (11.0)	1,550 (10.7)	1,500 (10.3)	1,400 (9.7)	D.6.5.2
Temp. range B ⁶	Characteristic bond stress in cracked concrete ^{6,7}	τ_{cr}	psi (MPa)	650 (4.5)	650 (4.5)	650 (4.5)	650 (4.5)	650 (4.5)	650 (4.5)	640 (4.4)	D.6.5.2
	Characteristic bond stress in uncracked concrete ^{6,7}	τ_{unscr}	psi (MPa)	1,210 (8.3)	1,170 (8.1)	1,140 (7.9)	1,110 (7.7)	1,070 (7.4)	1,040 (7.2)	970 (6.7)	D.6.5.2
Anchor category, water-filled hole		-	-	3	3	3	3	3	3	3	
Resistance modification factor		R_{wf}	-	0.75	0.75	0.75	0.75	0.75	0.75	0.75	
Submerged concrete											
Temp. range A ⁶	Characteristic bond stress in cracked concrete ^{6,7}	τ_{cr}	psi (MPa)	820 (5.7)	830 (5.7)	830 (5.7)	840 (5.8)	850 (5.9)	860 (5.9)	860 (5.9)	D.6.5.2
	Characteristic bond stress in uncracked concrete ^{6,7}	τ_{unscr}	psi (MPa)	1,530 (10.6)	1,500 (10.3)	1,470 (10.1)	1,430 (9.9)	1,400 (9.7)	1,370 (9.4)	1,300 (9.0)	D.6.5.2
Temp. range B ⁶	Characteristic bond stress in cracked concrete ^{6,7}	τ_{cr}	psi (MPa)	570 (3.9)	570 (3.9)	580 (4.0)	580 (4.0)	590 (4.1)	590 (4.1)	590 (4.1)	D.6.5.2
	Characteristic bond stress in uncracked concrete ^{6,7}	τ_{unscr}	psi (MPa)	1,060 (7.3)	1,030 (7.1)	1,010 (7.0)	990 (6.8)	960 (6.6)	940 (6.5)	900 (6.2)	D.6.5.2
Anchor category, underwater		-	-	3	3	3	3	3	3	3	
Resistance modification factor		R_{uw}	-	0.75	0.75	0.75	0.75	0.75	0.75	0.75	
Reduction for seismic tension		$\alpha_{N,seis}$	-	0.92	0.93	0.95	1.00	1.00	1.00	1.00	

3.2.4

- Design information in this table is taken from ICC-ES ESR-3814, dated January, 2016, tables 8 and 9, and converted for use with CSA A23.3-14 Annex D.
- See figure 4 of section 3.2.4.3.4.
- Minimum edge distance may be reduced to $45\text{mm} \leq c_{ai} < 5d$ provided T_{inst} is reduced. See ESR-3814 section 4.1.9.
- For all design cases, $\psi_{c,N} = 1.0$. The appropriate coefficient for breakout resistance for cracked concrete ($k_{c,scr}$) or uncracked concrete ($k_{c,unscr}$) must be used.
- For use with the load combinations of CSA A23.3-14 chapter 8. Condition B applies where supplementary reinforcement in conformance with CSA A23.3-14 section D.5.3 is not provided, or where pullout or pryout strength governs. For cases where the presence of supplementary reinforcement can be verified, the resistance modification factors associated with Condition A may be used.
- Temperature range A: Max. short term temperature = 130°F (55°C), max. long term temperature = 110°F (43°C).
Temperature range B: Max. short term temperature = 176°F (80°C), max. long term temperature = 110°F (43°C).
Short term elevated concrete temperatures are those that occur over brief intervals, e.g., as a result of diurnal cycling. Long term concrete temperatures are roughly constant over significant periods of time.
- Bond stress values corresponding to concrete compressive stress $f'_c = 2,500$ psi (17.2 MPa). For concrete compressive strength, f'_c , between 2,500 psi (17.2 MPa) and 8,000 psi (55.2 MPa), the tabulated characteristic bond stress may be increased by a factor of $(f'_c/2,500)^{0.25}$ [for SI: $(f'_c/17.2)^{0.25}$] for uncracked concrete and $(f'_c/2,500)^{0.15}$ [for SI: $(f'_c/17.2)^{0.15}$] for cracked concrete.
- For structures assigned to Seismic Design Categories C, D, E, or F, bond strength values must be multiplied by $\alpha_{N,seis}$.

3.2.4 HIT-RE 500 V3 Epoxy Adhesive Anchoring System

Table 72 - Hilti HIT-RE 500 V3 design information with Hilti HAS and HIT-V threaded rods in diamond core drilled holes in accordance with CSA A23.3-14 Annex D¹



Design parameter	Symbol	Units	Nominal rod diameter (in.)							Ref A23.3-14	
			3/8	1/2	5/8	3/4	7/8	1	1-1/4		
Nominal anchor diameter	d_a	mm	9.5	12.7	15.9	19.1	22.2	25.4	31.8		
Effective minimum embedment ²	h_{ef}	mm	60	70	79	89	89	102	127		
Effective maximum embedment ²	h_{ef}	mm	191	254	318	381	445	508	635		
Minimum concrete thickness ²	h_{min}	mm	$h_{ef} + 30$		$h_{ef} + 2d_o$						
Critical edge distance	c_{ac}	-	see ESR-3814, section 4.1.10								
Minimum edge distance	c_{min}^3	mm	48	64	79	95	111	127	159		
Minimum anchor spacing	s_{min}	mm	48	64	79	95	111	127	159		
Coeff. for factored concrete breakout resistance, uncracked concrete	$k_{c,uncr}^4$	-	10							D.6.2.2	
Coeff. for factored concrete breakout resistance, cracked concrete	$k_{c,cr}^4$	-	7							D.6.2.2	
Concrete material resistance factor	ϕ_s	-	0.65							8.4.2	
Resistance modification factor for tension and shear, concrete failure modes, Condition B ⁵	R_{conc}	-	1.00							D.5.3(c)	
Dry and water saturated concrete											
Temp. range A ⁶	Characteristic bond stress in uncracked concrete ^{6,7}	τ_{uncr}	psi	1,740	1,705	1,555	1,440	1,355	1,280	1,170	D.6.5.2
			(MPa)	(12.0)	(11.8)	(10.7)	(9.9)	(9.3)	(8.8)	(8.1)	
Temp. range B ⁶	Characteristic bond stress in uncracked concrete ^{6,7}	τ_{uncr}	psi	600	590	535	495	470	440	405	D.6.5.2
			(MPa)	(4.1)	(4.1)	(3.7)	(3.4)	(3.2)	(3.0)	(2.8)	
Anchor category, dry concrete		-	-	2	2	3	3	3	3	3	
Resistance modification factor		R_{dry}	-	0.85	0.85	0.75	0.75	0.75	0.75	0.75	

1 Design information in this table is taken from ICC-ES ESR-3814, dated January, 2016, tables 8 and 10, and converted for use with CSA A23.3-14 Annex D.

2 See figure 4 of section 3.2.4.3.4.

3 Minimum edge distance may be reduced to $45\text{mm} \leq c_{ai} < 5d$ provided T_{inst} is reduced. See ESR-3814 section 4.1.9.

4 For all design cases, $\psi_{c,N} = 1.0$. The appropriate coefficient for breakout resistance for cracked concrete ($k_{c,cr}$) or uncracked concrete ($k_{c,uncr}$) must be used.

5 For use with the load combinations of CSA A23.3-14 chapter 8. Condition B applies where supplementary reinforcement in conformance with CSA A23.3-14 section D.5.3 is not provided, or where pullout or pryout strength governs. For cases where the presence of supplementary reinforcement can be verified, the resistance modification factors associated with Condition A may be used.

6 Temperature range A: Max. short term temperature = 130°F (55°C), max. long term temperature = 110°F (43°C).

Temperature range B: Max. short term temperature = 176°F (80°C), max. long term temperature = 110°F (43°C).

Short term elevated concrete temperatures are those that occur over brief intervals, e.g., as a result of diurnal cycling. Long term concrete temperatures are roughly constant over significant periods of time.

7 Bond stress values corresponding to concrete compressive strength $f'_c = 2,500$ psi (17.2 MPa). For concrete compressive strength, f'_c , between 2,500 psi (17.2 MPa) and 8,000 psi (55.2 MPa), the tabulated characteristic bond stress may be increased by a factor of $(f'_c / 2,500)^{0.25}$ [for SI: $(f'_c / 17.2)^{0.25}$] for uncracked concrete.

HIT-RE 500 V3 Epoxy Adhesive Anchoring System 3.2.4

Table 73 - Hilti HIT-RE 500 V3 adhesive factored resistance with concrete/bond failure for threaded rod in uncracked concrete^{1,2,3,4,5,6,7,8,9,11}



Nominal anchor diameter in.	Effective embedment in. (mm)	Tension N _t				Shear V _t			
		f' _c = 20 MPa (2,900 psi) lb (kN)	f' _c = 25 MPa (3,625 psi) lb (kN)	f' _c = 30 MPa (4,350 psi) lb (kN)	f' _c = 40 MPa (5,800 psi) lb (kN)	f' _c = 20 MPa (2,900 psi) lb (kN)	f' _c = 25 MPa (3,625 psi) lb (kN)	f' _c = 30 MPa (4,350 psi) lb (kN)	f' _c = 40 MPa (5,800 psi) lb (kN)
3/8	2-3/8 (60)	3,060 (13.6)	3,425 (15.2)	3,750 (16.7)	4,330 (19.3)	3,060 (13.6)	3,425 (15.2)	3,750 (16.7)	4,330 (19.3)
	3-3/8 (86)	5,185 (23.1)	5,800 (25.8)	6,355 (28.3)	7,335 (32.6)	10,375 (46.1)	11,600 (51.6)	12,705 (56.5)	14,670 (65.3)
	4-1/2 (114)	7,985 (35.5)	8,930 (39.7)	9,430 (41.9)	10,130 (45.1)	15,970 (71.0)	17,855 (79.4)	18,855 (83.9)	20,260 (90.1)
	7-1/2 (191)	14,200 (63.2)	15,010 (66.8)	15,715 (69.9)	16,885 (75.1)	28,395 (126.3)	30,025 (133.6)	31,425 (139.8)	33,770 (150.2)
1/2	2-3/4 (70)	3,815 (17.0)	4,265 (19.0)	4,670 (20.8)	5,395 (24.0)	7,630 (33.9)	8,530 (37.9)	9,345 (41.6)	10,790 (48.0)
	4-1/2 (114)	7,985 (35.5)	8,930 (39.7)	9,780 (43.5)	11,295 (50.2)	15,970 (71.0)	17,855 (79.4)	19,560 (87.0)	22,585 (100.5)
	6 (152)	12,295 (54.7)	13,745 (61.1)	15,060 (67.0)	17,385 (77.3)	24,590 (109.4)	27,490 (122.3)	30,115 (134.0)	34,775 (154.7)
	10 (254)	24,390 (108.5)	25,790 (114.7)	26,995 (120.1)	29,005 (129.0)	48,785 (217.0)	51,585 (229.5)	53,990 (240.2)	58,015 (258.1)
5/8 ¹⁰	3-1/8 (79)	4,620 (20.6)	5,165 (23.0)	5,660 (25.2)	6,535 (29.1)	9,245 (41.1)	10,335 (46.0)	11,320 (50.4)	13,070 (58.1)
	5-5/8 (143)	11,160 (49.6)	12,480 (55.5)	13,670 (60.8)	15,785 (70.2)	22,320 (99.3)	24,955 (111.0)	27,335 (121.6)	31,565 (140.4)
	7-1/2 (191)	17,185 (76.4)	19,210 (85.5)	21,045 (93.6)	24,300 (108.1)	34,365 (152.9)	38,420 (170.9)	42,090 (187.2)	48,600 (216.2)
	12-1/2 (318)	36,620 (162.9)	38,725 (172.2)	40,530 (180.3)	43,550 (193.7)	73,245 (325.8)	77,445 (344.5)	81,055 (360.6)	87,100 (387.4)
3/4 ¹⁰	3-1/2 (89)	5,480 (24.4)	6,125 (27.2)	6,710 (29.8)	7,745 (34.5)	10,955 (48.7)	12,250 (54.5)	13,420 (59.7)	15,495 (68.9)
	6-3/4 (171)	14,670 (65.3)	16,400 (73.0)	17,970 (79.9)	20,745 (92.3)	29,340 (130.5)	32,805 (145.9)	35,935 (159.8)	41,495 (184.6)
	9 (229)	22,585 (100.5)	25,255 (112.3)	27,665 (123.1)	31,945 (142.1)	45,175 (200.9)	50,505 (224.7)	55,325 (246.1)	63,885 (284.2)
	15 (381)	48,600 (216.2)	53,740 (239.1)	56,250 (250.2)	60,445 (268.9)	97,200 (432.4)	107,485 (478.1)	112,495 (500.4)	120,885 (537.7)
7/8 ¹⁰	3-1/2 (89)	5,480 (24.4)	6,125 (27.2)	6,710 (29.8)	7,745 (34.5)	10,955 (48.7)	12,250 (54.5)	13,420 (59.7)	15,495 (68.9)
	7-7/8 (200)	18,485 (82.2)	20,670 (91.9)	22,640 (100.7)	26,145 (116.3)	36,975 (164.5)	41,340 (183.9)	45,285 (201.4)	52,290 (232.6)
	10-1/2 (267)	28,465 (126.6)	31,820 (141.6)	34,860 (155.1)	40,255 (179.1)	56,925 (253.2)	63,645 (283.1)	69,720 (310.1)	80,505 (358.1)
	17-1/2 (445)	61,240 (272.4)	68,470 (304.6)	73,325 (326.2)	78,795 (350.5)	122,485 (544.8)	136,940 (609.1)	146,650 (652.3)	157,585 (701.0)
1 ¹⁰	4 (102)	6,690 (29.8)	7,480 (33.3)	8,195 (36.5)	9,465 (42.1)	13,385 (59.5)	14,965 (66.6)	16,395 (72.9)	18,930 (84.2)
	9 (229)	22,585 (100.5)	25,255 (112.3)	27,665 (123.1)	31,945 (142.1)	45,175 (200.9)	50,505 (224.7)	55,325 (246.1)	63,885 (284.2)
	12 (305)	34,775 (154.7)	38,880 (172.9)	42,590 (189.5)	49,180 (218.8)	69,550 (309.4)	77,760 (345.9)	85,180 (378.9)	98,360 (437.5)
	20 (508)	74,825 (332.8)	83,655 (372.1)	91,640 (407.6)	98,875 (439.8)	149,650 (665.7)	167,310 (744.2)	183,280 (815.3)	197,755 (879.7)
1-1/4 ¹⁰	5 (127)	9,355 (41.6)	10,455 (46.5)	11,455 (51.0)	13,225 (58.8)	18,705 (83.2)	20,915 (93.0)	22,910 (101.9)	26,455 (117.7)
	11-1/4 (286)	31,565 (140.4)	35,290 (157.0)	38,660 (172.0)	44,640 (198.6)	63,135 (280.8)	70,585 (314.0)	77,320 (343.9)	89,285 (397.1)
	15 (381)	48,600 (216.2)	54,335 (241.7)	59,520 (264.8)	68,730 (305.7)	97,200 (432.4)	108,670 (483.4)	119,045 (529.5)	137,460 (611.4)
	25 (635)	104,570 (465.1)	116,910 (520.0)	128,070 (569.7)	141,095 (627.6)	209,140 (930.3)	233,825 (1040.1)	256,140 (1139.4)	282,190 (1255.2)



- See Section 3.1.8 for explanation on development of load values.
- See Section 3.1.8.6 to convert design strength value to ASD value.
- Linear interpolation between embedment depths and concrete compressive strengths is not permitted.
- Apply spacing, edge distance, and concrete thickness factors in tables 30 - 41 as necessary to the above values. Compare to the steel values in table 29. The lesser of the values is to be used for the design.
- Data is for temperature range A: Max. short term temperature = 130°F (55°C), max. long term temperature = 110°F (43°C). For temperature range B: Max. short term temperature = 176°F (80°C), max. long term temperature = 110°F (43°C) multiply above values by 0.69. Short term elevated concrete temperatures are those that occur over brief intervals, e.g., as a result of diurnal cycling. Long term concrete temperatures are roughly constant over significant periods of time.
- Tabular values are for dry concrete or water-saturated concrete conditions. For water-filled drilled holes multiply design strength by 0.51. For submerged (under water) applications multiply design strength by 0.44.
- Tabular values are for short term loads only. For sustained loads including overhead use, see Section 3.1.8.8.
- Tabular values are for normal-weight concrete only. For lightweight concrete multiply design strength by λ_a as follows: For sand-lightweight, λ_a = 0.51. For all-lightweight, λ_a = 0.45.
- Tabular values are for holes drilled in concrete with carbide tipped hammer drill bit. For diamond core drilling, except as indicated in note 10, multiply above values by 0.55. Diamond core drilling is not permitted for the water-filled or under-water (submerged) applications.
- Diamond core drilling with Hilti TE-YRT roughening tool is permitted for 5/8", 3/4", 7/8", 1", and 1-1/4". See Table 76.
- Tabular values are for static loads only. Seismic design is not permitted for uncracked concrete.

3.2.4 HIT-RE 500 V3 Epoxy Adhesive Anchoring System

Table 74 - Hilti HIT-RE 500 V3 adhesive factored resistance with concrete/bond failure for threaded rod in cracked concrete^{1,2,3,4,5,6,7,8,9,11}



Nominal anchor diameter in.	Effective embedment in. (mm)	Tension N _t				Shear V _t			
		f' _c = 20 MPa (2,900 psi) lb (kN)	f' _c = 25 MPa (3,625 psi) lb (kN)	f' _c = 30 MPa (4,350 psi) lb (kN)	f' _c = 40 MPa (5,800 psi) lb (kN)	f' _c = 20 MPa (2,900 psi) lb (kN)	f' _c = 25 MPa (3,625 psi) lb (kN)	f' _c = 30 MPa (4,350 psi) lb (kN)	f' _c = 40 MPa (5,800 psi) lb (kN)
3/8	2-3/8 (60)	2,145 (9.5)	2,395 (10.7)	2,530 (11.3)	2,645 (11.8)	2,145 (9.5)	2,395 (10.7)	2,530 (11.3)	2,645 (11.8)
	3-3/8 (86)	3,385 (15.1)	3,500 (15.6)	3,595 (16.0)	3,755 (16.7)	6,770 (30.1)	7,000 (31.1)	7,195 (32.0)	7,510 (33.4)
	4-1/2 (114)	4,515 (20.1)	4,665 (20.8)	4,795 (21.3)	5,005 (22.3)	9,025 (40.1)	9,335 (41.5)	9,590 (42.7)	10,015 (44.5)
	7-1/2 (191)	7,520 (33.5)	7,780 (34.6)	7,995 (35.6)	8,345 (37.1)	15,045 (66.9)	15,555 (69.2)	15,985 (71.1)	16,690 (74.2)
1/2	2-3/4 (70)	2,670 (11.9)	2,985 (13.3)	3,270 (14.5)	3,775 (16.8)	5,340 (23.8)	5,970 (26.6)	6,540 (29.1)	7,555 (33.6)
	4-1/2 (114)	5,590 (24.9)	6,175 (27.5)	6,345 (28.2)	6,625 (29.5)	11,180 (49.7)	12,345 (54.9)	12,690 (56.4)	13,250 (58.9)
	6 (152)	7,960 (35.4)	8,230 (36.6)	8,460 (37.6)	8,830 (39.3)	15,920 (70.8)	16,460 (73.2)	16,920 (75.3)	17,665 (78.6)
	10 (254)	13,265 (59.0)	13,720 (61.0)	14,100 (62.7)	14,720 (65.5)	26,535 (118.0)	27,435 (122.0)	28,200 (125.4)	29,440 (131.0)
5/8 ¹⁰	3-1/8 (79)	3,235 (14.4)	3,615 (16.1)	3,960 (17.6)	4,575 (20.4)	6,470 (28.8)	7,235 (32.2)	7,925 (35.2)	9,150 (40.7)
	5-5/8 (143)	7,810 (34.8)	8,735 (38.9)	9,570 (42.6)	10,270 (45.7)	15,625 (69.5)	17,470 (77.7)	19,135 (85.1)	20,540 (91.4)
	7-1/2 (191)	12,030 (53.5)	12,760 (56.8)	13,115 (58.3)	13,690 (60.9)	24,055 (107.0)	25,520 (113.5)	26,230 (116.7)	27,385 (121.8)
	12-1/2 (318)	20,565 (91.5)	21,265 (94.6)	21,855 (97.2)	22,820 (101.5)	41,135 (183.0)	42,535 (189.2)	43,715 (194.4)	45,640 (203.0)
3/4 ¹⁰	3-1/2 (89)	3,835 (17.1)	4,285 (19.1)	4,695 (20.9)	5,425 (24.1)	7,670 (34.1)	8,575 (38.1)	9,390 (41.8)	10,845 (48.2)
	6-3/4 (171)	10,270 (45.7)	11,480 (51.1)	12,575 (55.9)	14,525 (64.6)	20,540 (91.4)	22,965 (102.1)	25,155 (111.9)	29,045 (129.2)
	9 (229)	15,810 (70.3)	17,675 (78.6)	18,735 (83.3)	19,560 (87.0)	31,620 (140.7)	35,355 (157.3)	37,470 (166.7)	39,120 (174.0)
	15 (381)	29,380 (130.7)	30,380 (135.1)	31,225 (138.9)	32,600 (145.0)	58,760 (261.4)	60,760 (270.3)	62,445 (277.8)	65,200 (290.0)
7/8 ¹⁰	3-1/2 (89)	3,835 (17.1)	4,285 (19.1)	4,695 (20.9)	5,425 (24.1)	7,670 (34.1)	8,575 (38.1)	9,390 (41.8)	10,845 (48.2)
	7-7/8 (200)	12,940 (57.6)	14,470 (64.4)	15,850 (70.5)	18,300 (81.4)	25,880 (115.1)	28,935 (128.7)	31,700 (141.0)	36,605 (162.8)
	10-1/2 (267)	19,925 (88.6)	22,275 (99.1)	24,400 (108.5)	26,410 (117.5)	39,850 (177.3)	44,550 (198.2)	48,805 (217.1)	52,820 (235.0)
	17-1/2 (445)	39,670 (176.5)	41,020 (182.5)	42,160 (187.5)	44,020 (195.8)	79,340 (352.9)	82,040 (364.9)	84,315 (375.1)	88,035 (391.6)
1 ¹⁰	4 (102)	4,685 (20.8)	5,240 (23.3)	5,740 (25.5)	6,625 (29.5)	9,370 (41.7)	10,475 (46.6)	11,475 (51.0)	13,250 (58.9)
	9 (229)	15,810 (70.3)	17,675 (78.6)	19,365 (86.1)	22,360 (99.5)	31,620 (140.7)	35,355 (157.3)	38,730 (172.3)	44,720 (198.9)
	12 (305)	24,340 (108.3)	27,215 (121.1)	29,815 (132.6)	34,425 (153.1)	48,685 (216.6)	54,430 (242.1)	59,625 (265.2)	68,850 (306.3)
	20 (508)	51,815 (230.5)	53,580 (238.3)	55,065 (244.9)	57,490 (255.7)	103,630 (461.0)	107,155 (476.7)	110,130 (489.9)	114,985 (511.5)
1-1/4 ¹⁰	5 (127)	6,545 (29.1)	7,320 (32.6)	8,020 (35.7)	9,260 (41.2)	13,095 (58.2)	14,640 (65.1)	16,035 (71.3)	18,520 (82.4)
	11-1/4 (286)	22,095 (98.3)	24,705 (109.9)	27,060 (120.4)	31,250 (139.0)	44,195 (196.6)	49,410 (219.8)	54,125 (240.8)	62,500 (278.0)
	15 (381)	34,020 (151.3)	38,035 (169.2)	41,665 (185.3)	48,110 (214.0)	68,040 (302.7)	76,070 (338.4)	83,330 (370.7)	96,220 (428.0)
	25 (635)	73,200 (325.6)	79,665 (354.4)	81,875 (364.2)	85,485 (380.3)	146,395 (651.2)	159,330 (708.7)	163,750 (728.4)	170,970 (760.5)

- See Section 3.1.8 for explanation on development of load values.
- See Section 3.1.8.6 to convert design strength value to ASD value.
- Linear interpolation between embedment depths and concrete compressive strengths is not permitted.
- Apply spacing, edge distance, and concrete thickness factors in tables 30-41 as necessary to the above values. Compare to the steel values in table 29 to the above values. The lesser of the values is to be used for the design.
- Data is for temperature range A: Max. short term temperature = 130°F (55°C), max. long term temperature = 110°F (43°C).
For temperature range B: Max. short term temperature = 176 °F (80°C), max. long term temperature = 110°F (43°C) multiply above values by 0.69.
Short term elevated concrete temperatures are those that occur over brief intervals, e.g., as a result of diurnal cycling. Long term concrete temperatures are roughly constant over significant periods of time.
- Tabular values are for dry or water saturated concrete conditions.
For water-filled drilled holes multiply design strength by 0.51.
For submerged (under water) applications multiply design strength by 0.44.
- Tabular values are for short term loads only. For sustained loads including overhead use, see Section 3.1.8.8.
- Tabular values are for normal-weight concrete only. For lightweight concrete multiply design strength by λ_a as follows:
For sand-lightweight, λ_a = 0.51. For all-lightweight, λ_a = 0.45.
- Tabular values are for holes drilled in concrete with carbide tipped hammer drill bit. Diamond core drilling is not permitted in cracked concrete except as indicated in note 10.
- Diamond core drilling with Hilti TE-YRT roughening tool is permitted for 5/8", 3/4", 7/8", 1", and 1-1/4". See Table 77.
- Tabular values are for static loads only. For seismic loads, multiply cracked concrete tabular values by α_{seis} indicated below. See section 3.1.8.7 for additional information on seismic applications.
3/8-in. diameter - α_{seis} = 0.69
1/2-in. diameter - α_{seis} = 0.70
5/8-in. diameter - α_{seis} = 0.71
3/4-in. diameter and larger - α_{seis} = 0.75

HIT-RE 500 V3 Epoxy Adhesive Anchoring System 3.2.4

Table 75 - Hilti HIT-RE 500-V3 design information with HAS/HIT-V threaded rods in core drilled holes roughened with the TE-YRT Roughening Tool in accordance with CSA A23.3-14 Annex D^{1,8}



Design parameter	Symbol	Units	Nominal rod diameter (in.)					Ref A23.3-14	
			5/8	3/4	7/8	1	1-1/4		
Nominal anchor diameter	d_a	mm	15.9	19.1	22.2	25.4	31.8		
Effective minimum embedment ²	h_{ef}	mm	79	89	89	102	127		
Effective maximum embedment ²	h_{ef}	mm	318	286	445	508	635		
Minimum concrete thickness ²	h_{min}	mm	$h_{ef} + 2d_a$						
Critical edge distance	c_{ac}	-	see ESR-2322, section 4.1.10						
Minimum edge distance	c_{min}^3	mm	79	95	111	127	159		
Minimum anchor spacing	s_{min}	mm	79	95	111	127	159		
Coeff. for factored concrete breakout resistance, uncracked concrete	$k_{c,unscr}^4$	-	10					D.6.2.2	
Coeff. for factored concrete breakout resistance, cracked concrete	$k_{c,cr}^4$	-	7					D.6.2.2	
Concrete material resistance factor	ϕ_s	-	0.65					8.4.2	
Resistance modification factor for tension and shear, concrete failure modes, Condition B ⁵	R_{conc}	-	1.00					D.5.3(c)	
Dry and water saturated concrete									
Temp. range A ⁶	Characteristic bond stress in cracked concrete ^{6,7}	τ_{cr}	psi (MPa)	880 (6.1)	875 (6.0)	870 (6.0)	870 (6.0)	825 (5.7)	D.6.5.2
	Characteristic bond stress in uncracked concrete ^{6,7}	τ_{unscr}	psi (MPa)	2,210 (15.2)	2,130 (14.7)	2,040 (14.1)	1,960 (13.5)	1,790 (12.3)	D.6.5.2
Temp. range B ⁶	Characteristic bond stress in cracked concrete ^{6,7}	τ_{cr}	psi (MPa)	610 (4.2)	605 (4.2)	605 (4.2)	600 (4.1)	570 (3.9)	D.6.5.2
	Characteristic bond stress in uncracked concrete ^{6,7}	τ_{unscr}	psi (MPa)	1,530 (10.6)	1,470 (10.1)	1,410 (9.7)	1,350 (9.3)	1,240 (8.6)	D.6.5.2
Anchor category, dry concrete		-	-	1	1	1	1	1	
Resistance modification factor		R_{dry}	-	1.00	1.00	1.00	1.00	1.00	
Reduction for seismic tension		$\alpha_{N,seis}$	-	0.95	1.00	1.00	1.00	1.00	



3.2.4

- Design information in this table is taken from ICC-ES ESR-3814, dated January, 2016, table 11 and 12, and converted for use with CSA A23.3-14 Annex D.
- See figure 8 of section 3.2.4.3.4.
- Minimum edge distance may be reduced to $45\text{mm} \leq c_{ai} < 5d$ provided T_{inst} is reduced. See ESR-3814 section 4.1.9.
- For all design cases, $\psi_{c,N} = 1.0$. The appropriate coefficient for breakout resistance for cracked concrete ($k_{c,cr}$) or uncracked concrete ($k_{c,unscr}$) must be used.
- For use with the load combinations of CSA A23.3-14 chapter 8. Condition B applies where supplementary reinforcement in conformance with CSA A23.3-14 section D.5.3 is not provided, or where pullout or pryout strength governs. For cases where the presence of supplementary reinforcement can be verified, the resistance modification factors associated with Condition A may be used.
- Temperature range A: Max. short term temperature = 130°F (55°C), max. long term temperature = 110°F (43°C).
Temperature range B: Max. short term temperature = 176°F (80°C), max. long term temperature = 110°F (43°C).
Short term elevated concrete temperatures are those that occur over brief intervals, e.g., as a result of diurnal cycling. Long term concrete temperatures are roughly constant over significant periods of time.
- Bond stress values correspond to concrete compressive strength in the range $2,500 \text{ psi} \leq f'_c \leq 8,000 \text{ psi}$.
- For structures assigned to Seismic Design Categories C, D, E, or F, bond stress values must be multiplied by $\alpha_{N,seis}$.

3.2.4 HIT-RE 500 V3 Epoxy Adhesive Anchoring System

Table 76 - Hilti HIT-RE 500 V3 Core Drilled and roughened with TE-YRT Roughening Tool adhesive factored resistance with concrete / bond failure for threaded rod in uncracked concrete^{1,2,3,4,5,6,7,8,9}



Nominal anchor diameter in.	Effective embedment in. (mm)	Tension N_t				Shear V_f			
		$f'_c = 20$ MPa (2,900 psi) lb (kN)	$f'_c = 25$ MPa (3,625 psi) lb (kN)	$f'_c = 30$ MPa (4,350 psi) lb (kN)	$f'_c = 40$ MPa (5,800 psi) lb (kN)	$f'_c = 20$ MPa (2,900 psi) lb (kN)	$f'_c = 25$ MPa (3,625 psi) lb (kN)	$f'_c = 30$ MPa (4,350 psi) lb (kN)	$f'_c = 40$ MPa (5,800 psi) lb (kN)
5/8	3-1/8 (79)	4,620 (20.6)	5,165 (23.0)	5,660 (25.2)	6,535 (29.1)	9,245 (41.1)	10,335 (46.0)	11,320 (50.4)	13,070 (58.1)
	5-5/8 (143)	11,160 (49.6)	12,480 (55.5)	13,670 (60.8)	15,785 (70.2)	22,320 (99.3)	24,955 (111.0)	27,335 (121.6)	31,565 (140.4)
	7-1/2 (191)	17,185 (76.4)	19,210 (85.5)	21,045 (93.6)	21,160 (94.1)	34,365 (152.9)	38,420 (170.9)	42,090 (187.2)	42,320 (188.2)
	12-1/2 (318)	35,265 (156.9)	35,265 (156.9)	35,265 (156.9)	35,265 (156.9)	70,535 (313.7)	70,535 (313.7)	70,535 (313.7)	70,535 (313.7)
3/4	3-1/2 (89)	5,480 (24.4)	6,125 (27.2)	6,710 (29.8)	7,745 (34.5)	10,955 (48.7)	12,250 (54.5)	13,420 (59.7)	15,495 (68.9)
	6-3/4 (171)	14,670 (65.3)	16,400 (73.0)	17,970 (79.9)	20,745 (92.3)	29,340 (130.5)	32,805 (145.9)	35,935 (159.8)	41,495 (184.6)
	9 (229)	22,585 (100.5)	25,255 (112.3)	27,665 (123.1)	29,365 (130.6)	45,175 (200.9)	50,505 (224.7)	55,325 (246.1)	58,735 (261.3)
	11-1/4 (286)	31,565 (140.4)	35,290 (157.0)	36,710 (163.3)	36,710 (163.3)	63,135 (280.8)	70,585 (314.0)	73,420 (326.6)	73,420 (326.6)
7/8	3-1/2 (89)	5,480 (24.4)	6,125 (27.2)	6,710 (29.8)	7,745 (34.5)	10,955 (48.7)	12,250 (54.5)	13,420 (59.7)	15,495 (68.9)
	7-7/8 (200)	18,485 (82.2)	20,670 (91.9)	22,640 (100.7)	26,145 (116.3)	36,975 (164.5)	41,340 (183.9)	45,285 (201.4)	52,290 (232.6)
	10-1/2 (267)	28,465 (126.6)	31,820 (141.6)	34,860 (155.1)	38,285 (170.3)	56,925 (253.2)	63,645 (283.1)	69,720 (310.1)	76,565 (340.6)
	17-1/2 (445)	61,240 (272.4)	63,805 (283.8)	63,805 (283.8)	63,805 (283.8)	122,485 (544.8)	127,610 (567.6)	127,610 (567.6)	127,610 (567.6)
1	4 (102)	6,690 (29.8)	7,480 (33.3)	8,195 (36.5)	9,465 (42.1)	13,385 (59.5)	14,965 (66.6)	16,395 (72.9)	18,930 (84.2)
	9 (229)	22,585 (100.5)	25,255 (112.3)	27,665 (123.1)	31,945 (142.1)	45,175 (200.9)	50,505 (224.7)	55,325 (246.1)	63,885 (284.2)
	12 (305)	34,775 (154.7)	38,880 (172.9)	42,590 (189.5)	48,040 (213.7)	69,550 (309.4)	77,760 (345.9)	85,180 (378.9)	96,085 (427.4)
	20 (508)	74,825 (332.8)	80,070 (356.2)	80,070 (356.2)	80,070 (356.2)	149,650 (665.7)	160,140 (712.3)	160,140 (712.3)	160,140 (712.3)
1-1/4	5 (127)	9,355 (41.6)	10,455 (46.5)	11,455 (51.0)	13,225 (58.8)	18,705 (83.2)	20,915 (93.0)	22,910 (101.9)	26,455 (117.7)
	11-1/4 (286)	31,565 (140.4)	35,290 (157.0)	38,660 (172.0)	44,640 (198.6)	63,135 (280.8)	70,585 (314.0)	77,320 (343.9)	89,285 (397.1)
	15 (381)	48,600 (216.2)	54,335 (241.7)	59,520 (264.8)	68,555 (304.9)	97,200 (432.4)	108,670 (483.4)	119,045 (529.5)	137,110 (609.9)
	25 (635)	104,570 (465.1)	114,255 (508.2)	114,255 (508.2)	114,255 (508.2)	209,140 (930.3)	228,515 (1016.5)	228,515 (1016.5)	228,515 (1016.5)

1 See Section 3.1.8 for explanation on development of load values.

2 See Section 3.1.8.6 to convert design strength value to ASD value.

3 Linear interpolation between embedment depths and concrete compressive strengths is not permitted.

4 Apply spacing, edge distance, and concrete thickness factors in tables 30 - 41 as necessary to the above values. Compare to the steel values in table 29. The lesser of the values is to be used for the design.

5 Data is for temperature range A: Max. short term temperature = 130°F (55°C), max. long term temperature = 110°F (43°C).

For temperature range B: Max. short term temperature = 176°F (80°C), max. long term temperature = 110°F (43°C) multiply above values by 0.69.

Short term elevated concrete temperatures are those that occur over brief intervals, e.g., as a result of diurnal cycling. Long term concrete temperatures are roughly constant over significant periods of time.

6 Tabular values are for dry concrete or water-saturated concrete conditions. Water-filled and submerged (under water) applications are not permitted for this hole preparation method.

7 Tabular values are for short term loads only. For sustained loads including overhead use, see Section 3.1.8.8.

8 Tabular values are for normal-weight concrete only. For lightweight concrete multiply design strength by λ_a as follows:

For sand-lightweight, $\lambda_a = 0.51$. For all-lightweight, $\lambda_a = 0.45$.

9 Tabular values are for static loads only. Seismic design is not permitted for uncracked concrete.

HIT-RE 500 V3 Epoxy Adhesive Anchoring System 3.2.4

Table 77 - Hilti HIT-RE 500 V3 Core Drilled and roughened with TE-YRT Roughening Tool adhesive factored resistance with concrete / bond failure for threaded rod in cracked concrete^{1,2,3,4,5,6,7,8,9}



Nominal anchor diameter in.	Effective embedment in. (mm)	Tension N _t				Shear V _t			
		f' _c = 20 MPa (2,900 psi) lb (kN)	f' _c = 25 MPa (3,625 psi) lb (kN)	f' _c = 30 MPa (4,350 psi) lb (kN)	f' _c = 40 MPa (5,800 psi) lb (kN)	f' _c = 20 MPa (2,900 psi) lb (kN)	f' _c = 25 MPa (3,625 psi) lb (kN)	f' _c = 30 MPa (4,350 psi) lb (kN)	f' _c = 40 MPa (5,800 psi) lb (kN)
5/8	3-1/8 (79)	3,235 (14.4)	3,510 (15.6)	3,510 (15.6)	3,510 (15.6)	6,470 (28.8)	7,020 (31.2)	7,020 (31.2)	7,020 (31.2)
	5-5/8 (143)	6,320 (28.1)	6,320 (28.1)	6,320 (28.1)	6,320 (28.1)	12,640 (56.2)	12,640 (56.2)	12,640 (56.2)	12,640 (56.2)
	7-1/2 (191)	8,425 (37.5)	8,425 (37.5)	8,425 (37.5)	8,425 (37.5)	16,850 (75.0)	16,850 (75.0)	16,850 (75.0)	16,850 (75.0)
	12-1/2 (318)	14,045 (62.5)	14,045 (62.5)	14,045 (62.5)	14,045 (62.5)	28,085 (124.9)	28,085 (124.9)	28,085 (124.9)	28,085 (124.9)
3/4	3-1/2 (89)	3,835 (17.1)	4,285 (19.1)	4,690 (20.9)	4,690 (20.9)	7,670 (34.1)	8,575 (38.1)	9,385 (41.7)	9,385 (41.7)
	6-3/4 (171)	9,050 (40.2)	9,050 (40.2)	9,050 (40.2)	9,050 (40.2)	18,095 (80.5)	18,095 (80.5)	18,095 (80.5)	18,095 (80.5)
	9 (229)	12,065 (53.7)	12,065 (53.7)	12,065 (53.7)	12,065 (53.7)	24,130 (107.3)	24,130 (107.3)	24,130 (107.3)	24,130 (107.3)
	11-1/4 (286)	15,080 (67.1)	15,080 (67.1)	15,080 (67.1)	15,080 (67.1)	30,160 (134.2)	30,160 (134.2)	30,160 (134.2)	30,160 (134.2)
7/8	3-1/2 (89)	3,835 (17.1)	4,285 (19.1)	4,695 (20.9)	5,425 (24.1)	7,670 (34.1)	8,575 (38.1)	9,390 (41.8)	10,845 (48.2)
	7-7/8 (200)	12,245 (54.5)	12,245 (54.5)	12,245 (54.5)	12,245 (54.5)	24,490 (108.9)	24,490 (108.9)	24,490 (108.9)	24,490 (108.9)
	10-1/2 (267)	16,325 (72.6)	16,325 (72.6)	16,325 (72.6)	16,325 (72.6)	32,655 (145.2)	32,655 (145.2)	32,655 (145.2)	32,655 (145.2)
	17-1/2 (445)	27,210 (121.0)	27,210 (121.0)	27,210 (121.0)	27,210 (121.0)	54,420 (242.1)	54,420 (242.1)	54,420 (242.1)	54,420 (242.1)
1	4 (102)	4,685 (20.8)	5,240 (23.3)	5,740 (25.5)	6,625 (29.5)	9,370 (41.7)	10,475 (46.6)	11,475 (51.0)	13,250 (58.9)
	9 (229)	15,810 (70.3)	15,995 (71.1)	15,995 (71.1)	15,995 (71.1)	31,620 (140.7)	31,985 (142.3)	31,985 (142.3)	31,985 (142.3)
	12 (305)	21,325 (94.9)	21,325 (94.9)	21,325 (94.9)	21,325 (94.9)	42,650 (189.7)	42,650 (189.7)	42,650 (189.7)	42,650 (189.7)
	20 (508)	35,540 (158.1)	35,540 (158.1)	35,540 (158.1)	35,540 (158.1)	71,080 (316.2)	71,080 (316.2)	71,080 (316.2)	71,080 (316.2)
1-1/4	5 (127)	6,545 (29.1)	7,320 (32.6)	8,020 (35.7)	9,260 (41.2)	13,095 (58.2)	14,640 (65.1)	16,035 (71.3)	18,520 (82.4)
	11-1/4 (286)	22,095 (98.3)	23,695 (105.4)	23,695 (105.4)	23,695 (105.4)	44,195 (196.6)	47,395 (210.8)	47,395 (210.8)	47,395 (210.8)
	15 (381)	31,595 (140.5)	31,595 (140.5)	31,595 (140.5)	31,595 (140.5)	63,190 (281.1)	63,190 (281.1)	63,190 (281.1)	63,190 (281.1)
	25 (635)	52,660 (234.2)	52,660 (234.2)	52,660 (234.2)	52,660 (234.2)	105,320 (468.5)	105,320 (468.5)	105,320 (468.5)	105,320 (468.5)



3.2.4

- See Section 3.1.8 for explanation on development of load values.
- See Section 3.1.8.6 to convert design strength value to ASD value.
- Linear interpolation between embedment depths and concrete compressive strengths is not permitted.
- Apply spacing, edge distance, and concrete thickness factors in tables 30 - 41 as necessary to the above values. Compare to the steel values in table 29. The lesser of the values is to be used for the design.
- Data is for temperature range A: Max. short term temperature = 130°F (55°C), max. long term temperature = 110°F (43°C).
For temperature range B: Max. short term temperature = 176°F (80°C), max. long term temperature = 110°F (43°C) multiply above values by 0.69. Short term elevated concrete temperatures are those that occur over brief intervals, e.g., as a result of diurnal cycling. Long term concrete temperatures are roughly constant over significant periods of time.
- Tabular values are for dry concrete or water-saturated concrete conditions. Water-filled and submerged (under water) applications are not permitted for this hole preparation method.
Tabular values are for short term loads only. For sustained loads including overhead use, see Section 3.1.8.8.
- Tabular values are for normal-weight concrete only. For lightweight concrete multiply design strength by λ_a as follows:
For sand-lightweight, λ_a = 0.51. For all-lightweight, λ_a = 0.45.
- Tabular values are for static loads only. For seismic loads, multiply cracked concrete tabular values by α_{seis} indicated below. See section 3.1.8.7 for additional information on seismic applications.
5/8-in. diameter α_{seis} = 0.71
3/4-in. diameter and larger - α_{seis} = 0.75

3.2.4 HIT-RE 500 V3 Epoxy Adhesive Anchoring System

Table 78 - Hilti HIT-RE 500 V3 design information with Hilti HIS-N and HIS-RN internally threaded inserts in hammer drilled holes in accordance with CSA A23.3-14 Annex D^{1,7}

Design parameter	Symbol	Units	Nominal bolt/cap screw diameter (in.)				Ref A23.3-14	
			3/8	1/2	5/8	3/4		
HIS insert outside diameter	D	mm	16.5	20.5	25.4	27.6		
Effective embedment ²	h_{ef}	mm	110	125	170	205		
Min. concrete thickness ²	h_{min}	mm	150	170	230	270		
Critical edge distance	c_{ac}	-	see ESR-3814, section 4.1.10					
Minimum edge distance	c_{min}	mm	83	102	127	140		
Minimum anchor spacing	s_{min}	mm	83	102	127	140		
Coeff. for factored conc. breakout resistance, uncracked concrete	$k_{c,uncr}^3$	-	10				D.6.2.2	
Coeff. for factored conc. breakout resistance, cracked concrete	$k_{c,cr}^3$	-	7				D.6.2.2	
Concrete material resistance factor	ϕ_c	-	0.65				8.4.2	
Resistance modification factor for tension and shear, concrete failure modes, Condition B ⁵	R_{conc}	-	1.00				D.5.3(c)	
Dry and water saturated concrete								
Temp. range A ⁵	Characteristic bond stress in cracked concrete ^{6,7}	τ_{cr}	psi (MPa)	1,070 (7.4)	1,070 (7.4)	1,070 (7.4)	1,070 (7.4)	D.6.5.2
	Characteristic bond stress in uncracked concrete ^{6,7}	τ_{uncr}	psi (MPa)	1,790 (12.3)	1,790 (12.3)	1,790 (12.3)	1,790 (12.3)	D.6.5.2
Temp. range B ⁵	Characteristic bond stress in cracked concrete ^{6,7}	τ_{cr}	psi (MPa)	740 (5.1)	740 (5.1)	740 (5.1)	740 (5.1)	D.6.5.2
	Characteristic bond stress in uncracked concrete ^{6,7}	τ_{uncr}	psi (MPa)	1,240 (8.6)	1,240 (8.6)	1,240 (8.6)	1,240 (8.6)	D.6.5.2
Anchor category, dry concrete		-	-	1	1	1	1	
Resistance modification factor		R_{dry}	-	1.00	1.00	1.00	1.00	
Water-filled hole								
Temp. range A ⁵	Characteristic bond stress in cracked concrete ^{6,7}	τ_{cr}	psi (MPa)	800 (5.5)	810 (5.6)	820 (5.7)	820 (5.7)	D.6.5.2
	Characteristic bond stress in uncracked concrete ^{6,7}	τ_{uncr}	psi (MPa)	1,340 (9.2)	1,350 (9.3)	1,370 (9.4)	1,380 (9.5)	D.6.5.2
Temp. range B ⁵	Characteristic bond stress in cracked concrete ^{6,7}	τ_{cr}	psi (MPa)	550 (3.8)	560 (3.9)	570 (3.9)	570 (3.9)	D.6.5.2
	Characteristic bond stress in uncracked concrete ^{6,7}	τ_{uncr}	psi (MPa)	920 (6.3)	930 (6.4)	950 (6.6)	950 (6.6)	D.6.5.2
Anchor category, water-filled hole		-	-	3	3	3	3	
Resistance modification factor		R_{wf}	-	0.75	0.75	0.75	0.75	
Underwater applications								
Temp. range A ⁵	Characteristic bond stress in cracked concrete ^{6,7}	τ_{cr}	psi (MPa)	710 (4.9)	720 (5.0)	750 (5.2)	750 (5.2)	D.6.5.2
	Characteristic bond stress in uncracked concrete ^{6,7}	τ_{uncr}	psi (MPa)	1,190 (8.2)	1,210 (8.3)	1,250 (8.6)	1,260 (8.7)	D.6.5.2
Temp. range B ⁵	Characteristic bond stress in cracked concrete ^{6,7}	τ_{cr}	psi (MPa)	490 (3.4)	500 (3.4)	510 (3.5)	520 (3.6)	D.6.5.2
	Characteristic bond stress in uncracked concrete ^{6,7}	τ_{uncr}	psi (MPa)	820 (5.7)	840 (5.8)	860 (5.9)	870 (6.0)	D.6.5.2
Anchor category, underwater		-	-	3	3	3	3	
Resistance modification factor		R_{uw}	-	0.75	0.75	0.75	0.75	
Reduction for seismic tension		$\alpha_{N,seis}$	-	1.00	1.00	1.00	1.00	

- Design information in this table is taken from ICC-ES ESR-3814, dated January, 2016, tables 16 and 17, and converted for use with CSA A23.3-14 Annex D.
- See figure 3 of this section.
- For all design cases, $\psi_{c,N} = 1.0$. The appropriate coefficient for breakout resistance for cracked concrete ($k_{c,cr}$) or uncracked concrete ($k_{c,uncr}$) must be used.
- For use with the load combinations of CSA A23.3-14 chapter 8. Condition B applies where supplementary reinforcement in conformance with CSA A23.3-14 section D.5.3 is not provided, or where pullout or pryout strength governs. For cases where the presence of supplementary reinforcement can be verified, the resistance modification factors associated with Condition A may be used.
- Temperature range A: Max. short term temperature = 130°F (55°C), max. long term temperature = 110°F (43°C).
Temperature range B: Max. short term temperature = 176°F (80°C), max. long term temperature = 110°F (43°C).
Short term elevated concrete temperatures are those that occur over brief intervals, e.g., as a result of diurnal cycling. Long term concrete temperatures are roughly constant over significant periods of time.
- Bond stress values corresponding to concrete compressive strength $f'_c = 2,500$ psi (17.2 MPa). For concrete compressive strength, f'_c between 2,500 psi (17.2 MPa) and 8,000 psi (55.2 MPa), the tabulated characteristic bond stress may be increased by a factor of $(f'_c / 2,500)^{0.25}$ [for SI: $(f'_c / 17.2)^{0.25}$] for cracked concrete and $(f'_c / 2,500)^{0.15}$ [for SI: $(f'_c / 17.2)^{0.15}$] for uncracked concrete.
- For structures assigned to Seismic Design Categories C, D, E, or F, bond stress values must be multiplied by $\alpha_{N,seis}$.

HIT-RE 500 V3 Epoxy Adhesive Anchoring System 3.2.4

Table 79 - Hilti HIT-RE 500 V3 design information with Hilti HIS-N and HIS-RN internally threaded inserts in diamond core drilled holes in accordance with CSA A23.3-14 Annex D¹



Design parameter	Symbol	Units	Nominal bolt/cap screw diameter (in.)				Ref A23.3-14	
			3/8	1/2	5/8	3/4		
HIS insert outside diameter	D	mm	16.5	20.5	25.4	27.6		
Effective embedment ²	h_{ef}	mm	110	125	170	205		
Min. concrete thickness ²	h_{min}	mm	150	170	230	270		
Critical edge distance	c_{ac}	–	see ESR-3814, section 4.1.10					
Minimum edge distance	c_{min}	mm	83	102	127	140		
Minimum anchor spacing	s_{min}	mm	83	102	127	140		
Coeff. for factored conc. breakout resistance, uncracked concrete	$k_{c,uncr}$ ³	–	10				D.6.2.2	
Coeff. for factored conc. breakout resistance, cracked concrete	$k_{c,cr}$ ³	–	7				D.6.2.2	
Concrete material resistance factor	ϕ_c	–	0.65				8.4.2	
Resistance modification factor for tension and shear, concrete failure modes, Condition B ⁵	R_{conc}	–	1.00				D.5.3(c)	
Dry concrete								
Temp. range A ⁶	Characteristic bond stress in uncracked concrete ^{6,7}	τ_{cr}	psi	1,200	1,200	1,200	1,200	D.6.5.2
			(MPa)	(8.3)	(8.3)	(8.3)	(8.3)	
Temp. range B ⁶	Characteristic bond stress in uncracked concrete ^{6,7}	τ_{cr}	psi	830	830	830	830	D.6.5.2
			(MPa)	(5.7)	(5.7)	(5.7)	(5.7)	
Anchor category, dry concrete	–	–	3	3	3	3		
Resistance modification factor	R_{dry}	–	0.75	0.75	0.75	0.75		
Water saturated hole								
Temp. range A ⁶	Characteristic bond stress in uncracked concrete ^{6,7}	τ_{cr}	psi	1,200	1,200	1,200	1,200	D.6.5.2
			(MPa)	(8.3)	(8.3)	(8.3)	(8.3)	
Temp. range B ⁶	Characteristic bond stress in uncracked concrete ^{6,7}	τ_{cr}	psi	830	830	830	830	D.6.5.2
			(MPa)	(5.7)	(5.7)	(5.7)	(5.7)	
Anchor category, water-saturated conc.	–	–	3	3	3	3		
Resistance modification factor	R_{wt}	–	0.75	0.75	0.75	0.75		



3.2.4

- Design information in this table is taken from ICC-ES ESR-3814, dated January, 2016, tables 16 and 17, and converted for use with CSA A23.3-14 Annex D.
- See figure 8 of section 3.2.4.3.6.
- For all design cases, $\psi_{c,N} = 1.0$. The appropriate coefficient for breakout resistance for cracked concrete ($k_{c,cr}$) or uncracked concrete ($k_{c,uncr}$) must be used.
- For use with the load combinations of CSA A23.3-14 chapter 8. Condition B applies where supplementary reinforcement in conformance with CSA A23.3-14 section D.5.3 is not provided, or where pullout or pryout strength governs. For cases where the presence of supplementary reinforcement can be verified, the resistance modification factors associated with Condition A may be used.
- Temperature range A: Max. short term temperature = 130°F (55°C), max. long term temperature = 110°F (43°C).
Temperature range B: Max. short term temperature = 176°F (80°C), max. long term temperature = 110°F (43°C).
Short term elevated concrete temperatures are those that occur over brief intervals, e.g., as a result of diurnal cycling. Long term concrete temperatures are roughly constant over significant periods of time.
- Bond stress values corresponding to concrete compressive strength $f'_c = 2,500$ psi (17.2 MPa). For concrete compressive strength, f'_c between 2,500 psi (17.2 MPa) and 8,000 psi (55.2 MPa), the tabulated characteristic bond stress may be increased by a factor of $(f'_c/2,500)^{0.25}$ [for SI: $(f'_c/17.2)^{0.25}$] for uncracked concrete.

3.2.4 HIT-RE 500 V3 Epoxy Adhesive Anchoring System

Table 80 - Hilti HIT-RE 500 V3 adhesive factored resistance with concrete / bond failure for Hilti HIS-N and HIS-RN internally threaded inserts in uncracked concrete^{1,2,3,4,5,6,7,8,9,11}



Thread size	Effective embedment in. (mm)	Tension N_t				Shear V_s			
		$f'_c = 20$ MPa (2,900 psi) lb (kN)	$f'_c = 25$ MPa (3,625 psi) lb (kN)	$f'_c = 30$ MPa (4,350 psi) lb (kN)	$f'_c = 40$ MPa (5,800 psi) lb (kN)	$f'_c = 20$ MPa (2,900 psi) lb (kN)	$f'_c = 25$ MPa (3,625 psi) lb (kN)	$f'_c = 30$ MPa (4,350 psi) lb (kN)	$f'_c = 40$ MPa (5,800 psi) lb (kN)
3/8-16 UNC	4-3/8 (110)	7,540 (33.5)	8,430 (37.5)	9,235 (41.1)	10,660 (47.4)	15,080 (67.1)	16,860 (75.0)	18,470 (82.1)	21,325 (94.9)
1/2-13 UNC ¹⁰	5 (125)	9,135 (40.6)	10,210 (45.4)	11,185 (49.8)	12,915 (57.5)	18,265 (81.3)	20,420 (90.8)	22,370 (99.5)	25,830 (114.9)
5/8-11 UNC ¹⁰	6-3/4 (170)	14,485 (64.4)	16,195 (72.0)	17,740 (78.9)	20,485 (91.1)	28,970 (128.9)	32,390 (144.1)	35,480 (157.8)	40,970 (182.2)
3/4-10 UNC ¹⁰	8-1/8 (205)	19,180 (85.3)	21,445 (95.4)	23,490 (104.5)	27,125 (120.7)	38,360 (170.6)	42,890 (190.8)	46,985 (209.0)	54,255 (241.3)

- See Section 3.1.8 for explanation on development of load values.
- See Section 3.1.8.6 to convert design strength value to ASD value.
- Linear interpolation between embedment depths and concrete compressive strengths is not permitted.
- Apply spacing, edge distance, and concrete thickness factors in tables 50 - 51 as necessary to the above values. Compare to the steel values in table 49. The lesser of the values is to be used for the design.
- Data is for temperature range A: Max. short term temperature = 130°F (55°C), max. long term temperature = 110°F (43°C).
For temperature range B: Max. short term temperature = 176°F (80°C), max. long term temperature = 110°F (43°C) multiply above values by 0.69.
- Tabular values are for dry concrete or water-saturated concrete conditions.
For water-filled drilled holes multiply design strength by 0.52.
For submerged (under water) applications multiply design strength by 0.46.
- Tabular values are for short term loads only. For sustained loads including overhead use, see Section 3.1.8.8.
- Tabular values are for normal-weight concrete only. For lightweight concrete multiply design strength (factored resistance) by λ_a as follows:
For sand-lightweight, $\lambda_a = 0.51$. For all-lightweight, $\lambda_a = 0.45$.
- Tabular values are for holes drilled in concrete with carbide tipped hammer drill bit. For diamond core drilling, except as indicated in note 10, multiply uncracked concrete tabular values by 0.57.
Diamond core drilling is not permitted for the water-filled or under-water (submerged) applications.
- Diamond core drilling with Hilti TE-YRT roughening tool is permitted for 1/2-13 UNC, 5/8-11 UNC, and 3/4-10 UNC anchors in dry and water-saturated concrete. See Table 83.
- Tabular values are for static loads only. Seismic design is not permitted for uncracked concrete.

Table 81 - Hilti HIT-RE 500 V3 adhesive factored resistance with concrete / bond failure for Hilti HIS-N and HIS-RN internally threaded inserts in cracked concrete^{1,2,3,4,5,6,7,8,9,11}



Thread size	Effective embedment in. (mm)	Tension N_t				Shear V_s			
		$f'_c = 20$ MPa (2,900 psi) lb (kN)	$f'_c = 25$ MPa (3,625 psi) lb (kN)	$f'_c = 30$ MPa (4,350 psi) lb (kN)	$f'_c = 40$ MPa (5,800 psi) lb (kN)	$f'_c = 20$ MPa (2,900 psi) lb (kN)	$f'_c = 25$ MPa (3,625 psi) lb (kN)	$f'_c = 30$ MPa (4,350 psi) lb (kN)	$f'_c = 40$ MPa (5,800 psi) lb (kN)
3/8-16 UNC	4-3/8 (110)	5,280 (23.5)	5,900 (26.2)	6,465 (28.8)	6,985 (31.1)	10,555 (47.0)	11,800 (52.5)	12,925 (57.5)	13,965 (62.1)
1/2-13 UNC ¹⁰	5 (125)	6,395 (28.4)	7,150 (31.8)	7,830 (34.8)	9,040 (40.2)	12,785 (56.9)	14,295 (63.6)	15,660 (69.7)	18,080 (80.4)
5/8-11 UNC ¹⁰	6-3/4 (170)	10,140 (45.1)	11,335 (50.4)	12,420 (55.2)	14,340 (63.8)	20,280 (90.2)	22,675 (100.9)	24,835 (110.5)	28,680 (127.6)
3/4-10 UNC ¹⁰	8-1/8 (205)	13,425 (59.7)	15,010 (66.8)	16,445 (73.1)	18,990 (84.5)	26,855 (119.5)	30,025 (133.5)	32,890 (146.3)	37,975 (168.9)

- See Section 3.1.8 for explanation on development of load values.
- See Section 3.1.8.6 to convert design strength value to ASD value.
- Linear interpolation between embedment depths and concrete compressive strengths is not permitted.
- Apply spacing, edge distance, and concrete thickness factors in tables 50-51 as necessary to the above values. Compare to the steel values in table 49. The lesser of the values is to be used for the design.
- Data is for temperature range A: Max. short term temperature = 130 (55°C), max. long term temperature = 110°F (43°C).
For temperature range B: Max. short term temperature = 176°F (80°C), max. long term temperature = 110°F (43°C) multiply above values by 0.69.
Short term elevated concrete temperatures are those that occur over brief intervals, e.g., as a result of diurnal cycling. Long term concrete temperatures are roughly constant over significant periods of time.
- Tabular values are for dry concrete or water-saturated concrete conditions.
For water-filled drilled holes multiply design strength by 0.52.
For submerged (under water) applications multiply design strength by 0.46.
- Tabular values are for short term loads only. For sustained loads including overhead use, see Section 3.1.8.8.
- Tabular values are for normal-weight concrete only. For lightweight concrete multiply design strength (factored resistance) by λ_a as follows:
For sand-lightweight, $\lambda_a = 0.51$. For all-lightweight, $\lambda_a = 0.45$.
- Tabular values are for holes drilled in concrete with carbide tipped hammer drill bit. Diamond core drilling is not permitted in cracked concrete except as indicated in note 10.
- Diamond core drilling is permitted in cracked concrete with use of the Hilti TE-YRT roughening tool for 1/2-13 UNC, 5/8-11 UNC, and 3/4-10 UNC anchors in dry and water-saturated concrete. See Table 84.
- Tabular values are for static loads only. For seismic loads, multiply cracked concrete tabular values by $\alpha_{seis} = 0.75$. See section 3.1.8.7 for additional information on seismic applications.

HIT-RE 500 V3 Epoxy Adhesive Anchoring System 3.2.4

Table 82 - Hilti HIT-RE 500 V3 design information with Hilti HIS-N and HIS-RN internally threaded inserts in core drilled holes roughened with the TE-YRT Roughening Tool in accordance with CSA A23.3-14 Annex D¹



Design parameter	Symbol	Units	Nominal bolt/cap screw diameter (in.)			Ref	
			1/2	5/8	3/4		
HIS insert outside diameter	D	mm	20.5	25.4	27.6	A23.3-14	
Effective embedment ²	h_{ef}	mm	125	170	205		
Min. concrete thickness ²	h_{min}	mm	170	230	270		
Critical edge distance	c_{ac}	-	See ESR-2322, section 4.1.10				
Minimum edge distance	c_{min}	mm	102	127	140		
Minimum anchor spacing	s_{min}	mm	102	127	140		
Coeff. for factored conc. breakout resistance, uncracked concrete	$k_{c,un-cr}^{-3}$	-	10			D.6.2.2	
Coeff. for factored conc. breakout resistance, cracked concrete	$k_{c,cr}^{-3}$	-	7			D.6.2.2	
Concrete material resistance factor	ϕ_c	-	0.65			8.4.2	
Resistance modification factor for tension and shear, concrete failure modes, Condition B ⁵	R_{conc}	-	1.00			D.5.3(c)	
Dry and water saturated concrete							
Temp. range A ⁵	Characteristic bond stress in cracked concrete ^{6,7}	τ_{cr}	psi (MPa)	750 (5.2)	750 (5.2)	750 (5.2)	D.6.5.2
	Characteristic bond stress in uncracked concrete ^{6,7}	τ_{un-cr}	psi (MPa)	1,790 (12.3)	1,790 (12.3)	1,790 (12.3)	D.6.5.2
Temp. range B ⁵	Characteristic bond stress in cracked concrete ^{6,7}	τ_{cr}	psi (MPa)	515 (3.6)	515 (3.6)	515 (3.6)	D.6.5.2
	Characteristic bond stress in uncracked concrete ^{6,7}	τ_{un-cr}	psi (MPa)	1,240 (8.6)	1,240 (8.6)	1,240 (8.6)	D.6.5.2
Anchor category, dry concrete		-	-	1	1	1	
Resistance modification factor		R_{dry}	-	1.00	1.00	1.00	
Reduction for seismic tension		$\alpha_{N,seis}$	-	1.00	1.00	1.00	



1 Design information in this table is taken from ICC-ES ESR-3814, dated January, 2016, table 29, and converted for use with CSA A23.3-14 Annex D.

2 See figure 8 of section 3.2.4.3.6.

3 For all design cases, $\psi_{c,N} = 1.0$. The appropriate coefficient for breakout resistance for cracked concrete ($k_{c,cr}$) or uncracked concrete ($k_{c,un-cr}$) must be used.

4 For use with the load combinations of CSA A23.3-14 chapter 8. Condition B applies where supplementary reinforcement in conformance with CSA A23.3-14 section D.5.3 is not provided, or where pullout or pryout strength governs. For cases where the presence of supplementary reinforcement can be verified, the resistance modification factors associated with Condition A may be used.

5 Temperature range A: Max. short term temperature = 130°F (55°C), max. long term temperature = 110°F (43°C).

Temperature range B: Max. short term temperature = 176°F (80°C), max. long term temperature = 110°F (43°C).

Short term elevated concrete temperatures are those that occur over brief intervals, e.g., as a result of diurnal cycling. Long term concrete temperatures are roughly constant over significant periods of time.

6 Bond stress values correspond to concrete compressive strength in the range $2,500 \text{ psi} \leq f'_c \leq 8,000 \text{ psi}$.

7 For structures assigned to Seismic Design Categories C, D, E, or F, bond stress values must be multiplied by $\alpha_{N,seis}$.

3.2.4 HIT-RE 500 V3 Epoxy Adhesive Anchoring System

Table 83 - Hilti HIT-RE 500-V3 adhesive core drilled and roughened with TE-YRT Roughening Tool factored resistance with concrete / bond failure for Hilti HIS-N and HIS-RN internally threaded inserts in uncracked concrete^{1,2,3,4,5,6,7,8}

Thread size	Effective embedment in. (mm)	Tension N_t				Shear V_s			
		$f'_c = 20$ MPa (2,900 psi) lb (kN)	$f'_c = 25$ MPa (3,625 psi) lb (kN)	$f'_c = 30$ MPa (4,350 psi) lb (kN)	$f'_c = 40$ MPa (5,800 psi) lb (kN)	$f'_c = 20$ MPa (2,900 psi) lb (kN)	$f'_c = 25$ MPa (3,625 psi) lb (kN)	$f'_c = 30$ MPa (4,350 psi) lb (kN)	$f'_c = 40$ MPa (5,800 psi) lb (kN)
1/2-13 UNC	5 (125)	9,135 (40.6)	10,210 (45.4)	11,185 (49.8)	12,915 (57.5)	18,265 (81.3)	20,420 (90.8)	22,370 (99.5)	25,830 (114.9)
5/8-11 UNC	6-3/4 (170)	14,485 (64.4)	16,195 (72.0)	17,740 (78.9)	20,485 (91.1)	28,970 (128.9)	32,390 (144.1)	35,480 (157.8)	40,970 (182.2)
3/4-10 UNC	8-1/8 (205)	19,180 (85.3)	21,445 (95.4)	23,490 (104.5)	27,125 (120.7)	38,360 (170.6)	42,890 (190.8)	46,985 (209.0)	54,255 (241.3)

Table 84 - Hilti HIT-RE 500 V3 adhesive core drilled and roughened with TE-YRT Roughening Tool factored resistance with concrete / bond failure for Hilti HIS-N and HIS-RN internally threaded inserts in cracked concrete^{1,2,3,4,5,6,7,8,9}

Thread size	Effective embedment in. (mm)	Tension N_t				Shear V_s			
		$f'_c = 20$ MPa (2,900 psi) lb (kN)	$f'_c = 25$ MPa (3,625 psi) lb (kN)	$f'_c = 30$ MPa (4,350 psi) lb (kN)	$f'_c = 40$ MPa (5,800 psi) lb (kN)	$f'_c = 20$ MPa (2,900 psi) lb (kN)	$f'_c = 25$ MPa (3,625 psi) lb (kN)	$f'_c = 30$ MPa (4,350 psi) lb (kN)	$f'_c = 40$ MPa (5,800 psi) lb (kN)
1/2-13 UNC	5 (125)	6,105 (27.2)	6,105 (27.2)	6,105 (27.2)	6,105 (27.2)	12,215 (54.3)	12,215 (54.3)	12,215 (54.3)	12,215 (54.3)
5/8-11 UNC	6-3/4 (170)	10,140 (45.1)	10,255 (45.6)	10,255 (45.6)	10,255 (45.6)	20,280 (90.2)	20,505 (91.2)	20,505 (91.2)	20,505 (91.2)
3/4-10 UNC	8-1/8 (205)	13,425 (59.7)	13,475 (59.9)	13,475 (59.9)	13,475 (59.9)	26,855 (119.5)	26,955 (119.9)	26,955 (119.9)	26,955 (119.9)

- See Section 3.1.8 for explanation on development of load values.
- See Section 3.1.8.6 to convert design strength value to ASD value.
- Linear interpolation between embedment depths and concrete compressive strengths is not permitted.
- Apply spacing, edge distance, and concrete thickness factors in tables 50 - 51 as necessary to the above values. Compare to the steel values in table 49. The lesser of the values is to be used for the design.
- Data is for temperature range A: Max. short term temperature = 130°F (55°C), max. long term temperature = 110°F (43°C). For temperature range B: Max. short term temperature = 176°F (80°C), max. long term temperature = 110°F (43°C) multiply above values by 0.69. Short term elevated concrete temperatures are those that occur over brief intervals, e.g., as a result of diurnal cycling. Long term concrete temperatures are roughly constant over significant periods of time.
- Tabular values are for dry concrete or water-saturated concrete conditions. Water-filled and submerged (under water) applications are not permitted for this hole preparation method.
- Tabular values are for short term loads only. For sustained loads including overhead use, see Section 3.1.8.8.
- Tabular values are for normal-weight concrete only. For lightweight concrete multiply design strength (factored resistance) by λ_a as follows: For sand-lightweight, $\lambda_a = 0.51$. For all-lightweight, $\lambda_a = 0.45$.
- Tabular values are for static loads only. For seismic loads, multiply cracked concrete tabular values by $\alpha_{seis} = 0.75$. See section 3.1.8.7 for additional information on seismic applications.

Table 85 - Steel factored resistance for steel bolt/cap screw for Hilti HIS-N and HIS-RN internally threaded inserts^{1,2,3}

Thread size	ASTM A193 B7			ASTM A193 Grade B8M Stainless Steel		
	Tensile ⁴ N_{sar} lb (kN)	Shear ⁵ V_{sar} lb (kN)	Seismic Shear ⁶ $V_{sar,eq}$ lb (kN)	Tensile ⁴ N_{sar} lb (kN)	Shear ⁵ V_{sar} lb (kN)	Seismic Shear ⁶ $V_{sar,eq}$ lb (kN)
3/8-16 UNC	5,765 (25.6)	3,215 (14.3)	2,250 (10.0)	5,070 (22.6)	2,825 (12.6)	1,975 (8.8)
1/2-13 UNC	9,635 (42.9)	5,880 (26.2)	4,115 (18.3)	9,290 (41.3)	5,175 (23.0)	3,620 (16.1)
5/8-11 UNC	16,020 (71.3)	9,365 (41.7)	6,555 (29.2)	14,790 (65.8)	8,240 (36.7)	5,770 (25.7)
3/4-10 UNC	16,280 (72.4)	13,860 (61.7)	9,700 (43.1)	21,895 (97.4)	12,195 (54.2)	8,535 (38.0)

- See Section 3.1.8.6 to convert design strength value to ASD value.
- Hilti HIS-N and HIS-RN inserts with steel bolts are considered brittle steel elements.
- Table values are the lesser of steel failure in the HIS-N insert or inserted steel bolt.
- Tensile = $A_{se,N} \phi_s f_{uta} R$ as noted in CSA A23.3-14 Annex D
- Shear = $A_{se,V} \phi_s 0.60 f_{uta} R$ as noted in CSA A23.3-14 Annex D. For 3/8-in diameter insert, shear = $A_{se,V} \phi_s 0.50 f_{uta} R$.
- Seismic Shear = $\alpha_{seis} V_{sar}$: Reduction factor for seismic shear only. See section 3.1.8.7 for additional information on seismic applications.

HIT-RE 500 V3 Epoxy Adhesive Anchoring System 3.2.4

3.2.4.3.8 Development and splicing of post-installed reinforcement



Calculations for post-installed rebar for typical development lengths may be done according to ACI 318-14 Chapter 25 (formerly ACI 318-11 Chapter 12) and CSA A23.3-14 Chapter 12 for adhesive anchors tested and approved in accordance with AC 308. This section contains tables for the data provided in ICC Evaluation Services ESR-3814. Refer to section 3.1.14 and the Hilti North America Post-Installed Reinforcing Bar Guide for the design method.

Table 86 - Calculated tension development and Class B Splice lengths for Grade 60 bars in walls, slabs, columns, and footings per ACI 318-14 Chapter 25 for Hilti HIT-RE 500 V3

Rebar size	$\frac{c_b + K_{tr}}{d_b}$	min. edge dist. in. ¹	min. spacing in. ²	$f'_c = 2,500$ psi		$f'_c = 3,000$ psi		$f'_c = 4,000$ psi		$f'_c = 6,000$ psi	
				ℓ_d in.	Class B splice in.	ℓ_d in.	Class B splice in.	ℓ_d in.	Class B splice in.	ℓ_d in.	Class B splice in.
#3	2.5	2-1/4	2	12	14	12	13	12	12	12	12
#4		2-3/4	2-1/2	14	19	13	17	12	15	12	12
#5		3	3-1/4	18	23	16	21	14	18	12	15
#6		3-3/4	3-3/4	22	28	20	26	17	22	14	18
#7		4-1/2	4-1/2	32	41	29	37	25	32	20	26
#8		5	5	36	47	33	43	28	37	23	30
#9		5-1/4	5-3/4	41	53	37	48	32	42	26	34
#10		5-3/4	6-1/2	46	59	42	54	36	47	30	38

- Edge distances are determined using the minimum cover specified by ESR-3814 with an additional 6% of the development length per suggestions for drilling without an aid per Hilti Post-Installed Reinforcing Bar Guide Section 3.3. Smaller edge distances may be possible, for which development and splice lengths may need to be recalculated. For further information on required cover see ACI 318-14, Sec. 20.6.1.3.1; see Sec. 2.2 for determination of c_b .
- Spacing values represent those producing $c_b = 5 d_b$ rounded up to the nearest 1/4 in. Smaller spacing values may be possible, for which development and splice lengths may need to be recalculated. For further information on required spacing see ACI 318-14 Sec. 25.2; see Sec. 2.2 for determination of c_b .
- $\psi_t = 1.0$ See ACI 318-14, Sec. 25.4.2.4.
- $\psi_e = 1.0$ for non-epoxy coated bars. See ACI 318-14, Sec. 25.4.2.4.
- $\psi_s = 0.8$ for #6 bars and smaller bars, 1.0 for #7 and larger bars. See ACI 318-14, Sec. 25.4.2.4.
- Values are for normal weight concrete. For sand-lightweight concrete, multiply development and splice lengths by 1.18, for all-lightweight concrete multiply development and splice lengths by 1.33. See ACI 318-14 Sec. 19.2.4.
- Development and splice length values are for static design. Seismic design development and splice lengths can be found in ACI 318-14 18.8.5 for special moment frames and ACI 318-14 18.10.2.3 for special structural walls. For further information about reinforcement in seismic design, see ACI 318-14 Ch. 18.
- Refer to the Hilti North America Post-Installed Reinforcing Bar Guide for further explanation, background information, and design examples.



3.2.4

3.2.4 HIT-RE 500 V3 Epoxy Adhesive Anchoring System

Table 87 - Suggested embedment, edge distance, and spacing (see figure below) to develop 125% of f_y in Grade 60 bars based on ACI 318-14 Chapter 17 - SDC A and B only^{1,2,3,4,5,6,7}

Rebar size	$f'_c = 2,500$ psi				$f'_c = 3,000$ psi				$f'_c = 4,000$ psi				$f'_c = 6,000$ psi			
	Effective embed. h_{ef} in.	Minimum edge dist $C_{a,min}$ in.		Min. spacing s_{min} in.	Effective embed. h_{ef} in.	Minimum edge dist $C_{a,min}$ in.		Min. spacing s_{min} in.	Effective embed. h_{ef} in.	Minimum edge dist $C_{a,min}$ in.		Min. spacing s_{min} in.	Effective embed. h_{ef} in.	Minimum edge dist $C_{a,min}$ in.		Min. spacing s_{min} in.
		Cond. I	Cond. II			Cond. I	Cond. II			Cond. I	Cond. II			Cond. I	Cond. II	
#3	7	17	8	15	6	16	7	14	6	16	7	13	5	15	6	11
#4	9	23	11	22	9	23	11	21	8	22	10	19	7	20	9	17
#5	11	29	15	29	11	28	14	28	10	27	13	25	9	25	11	22
#6	13	35	19	37	13	34	18	35	12	32	16	32	11	30	14	28
#7	16	41	23	45	15	40	22	43	14	38	20	39	13	36	17	34
#8	18	48	27	54	17	46	26	51	16	44	24	47	15	42	21	41
#9	21	56	32	63	20	54	30	60	18	50	27	54	17	47	24	48
#10	25	65	37	74	24	63	35	70	22	58	32	64	19	54	28	56

- For additional information see May-June 2013 issue of the ACI Structural Journal, "Recommended Procedures for Development and Splicing of Post-Installed Bonded Reinforcing Bars in Concrete Structures" by Charney, Pal and Silva.
- h_{ef} is the calculated bar embedment based on uncracked bond and concrete breakout strengths using equations in section 3.1.14.3 to develop 125% of nominal bar yield. Bond stresses apply for sustained and non-sustained load conditions. Additional reductions per ACI 318-14, 17.3.1.2 are not included, however, and as such these embedments are not intended for sustained tension load applications. The particular assumptions used for the application of anchor theory to bar development (e.g., bar yield and bond strength values) are a matter of engineering judgment and will in part depend on the specific circumstances of the design. For embedments corresponding to nominal yield (i.e., no overstrength) multiply the unbolded and bolded tabulated h_{ef} values by 0.80 and 0.86, respectively. Reduction factors for non-sustained loading and no bar overstrength may be combined.
- c_a and s are the minimum edge distance and bar spacing (from bar centerline) associated with the tabulated embedments. Refer to sec. 3.1.14.3 for applicability of edge distance "Condition I" and "Condition II."
- Applicable for hammer-drilled holes. For rock-drilled and core-drilled holes, contact Hilti.
- Values determined with bond stresses, k-factors and strength reduction factors taken from ESR-3814 Tables 12 and 13 assuming dry, uncracked concrete conditions where concrete temperatures will not exceed a maximum short-term temperature of 130°F (55°C) and long-term temperature of 110°F (43°C). Bond stresses are for static (non-seismic) loading conditions.
- Values are for normal weight concrete. For lightweight concrete contact Hilti.
- Refer to the Hilti North America Post-Installed Reinforcing Bar Guide for further explanation, background information, and design examples. See Hilti Instructions for Use (IFU) for specific installation requirements.

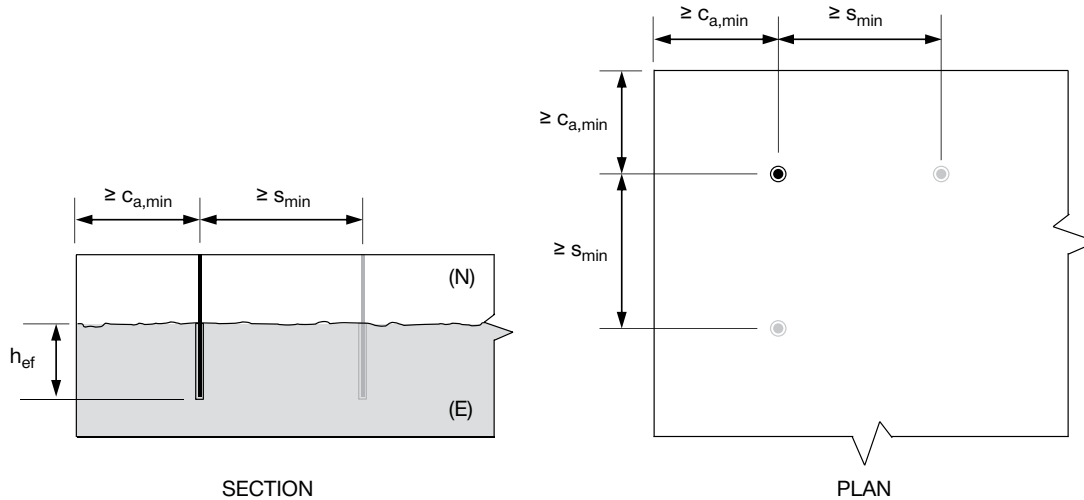

Illustration of Table 84 dimensions

HIT-RE 500 V3 Epoxy Adhesive Anchoring System 3.2.4

Table 88 - Suggested embedment and edge distance (see figure below) based on ACI 318-14 Chapter 17 to develop 125% of f_y in Grade 60 wall/column starter bars in a linear array with bar spacing = 24 inches - SDC A and B only^{1,2,3,4,5,6}

Rebar size	Linear spacing s in.	$f'_c = 2,500$ psi			$f'_c = 3,000$ psi			$f'_c = 4,000$ psi			$f'_c = 6,000$ psi		
		Effective embed. h_{ef} in.	Minimum edge dist $c_{a,min}$ in.		Effective embed. h_{ef} in.	Minimum edge dist $c_{a,min}$ in.		Effective embed. h_{ef} in.	Minimum edge dist $c_{a,min}$ in.		Effective embed. h_{ef} in.	Minimum edge dist $c_{a,min}$ in.	
			Cond. I	Cond. II		Cond. I	Cond. II		Cond. I	Cond. II		Cond. I	Cond. II
#3	24	7	17	8	6	16	7	6	16	7	5	15	6
#4		9	23	11	9	23	11	8	22	10	7	20	9
#5		13	34	19	11	30	17	10	27	13	9	25	11
#6		21	57	32	19	51	28	15	43	23	11	32	17
#7		-	-	-	-	-	-	24	66	35	18	52	27

- h_{ef} is the calculated bar embedment based on uncracked bond and concrete breakout strengths using equations in section 3.1.14.4 to develop 125% of nominal bar yield. Shaded embedment values exceed 20 bar diameters. For non-tabulated rebar sizes, design per development length provisions is recommended. The particular assumptions used for the application of anchor theory to bar development (e.g., bar yield and bond strength values) are a matter of engineering judgment and will in part depend on the specific circumstances of the design. For embedments corresponding to nominal yield (i.e., no overstrength) multiply the tabulated h_{ef} values by 0.86.
- c_a is the minimum edge distance (from bar centerline) associated with the tabulated embedments and $s = 24$ in. Refer to sec. 3.1.14.3 for applicability of edge distance "Condition I" and "Condition II."
- Applicable for hammer-drilled holes. For rock-drilled and core-drilled holes, contact Hilti.
- Values determined with bond stresses, k-factors and strength reduction factors taken from ESR-3814 Tables 12 and 13 assuming dry concrete conditions where concrete temperatures will not exceed a maximum short-term temperature of 130°F (55°C) and long-term temperature of 110°F (43°C). Bond stresses are for static (non-seismic) loading conditions.
- Values are for normal weight concrete. For lightweight concrete contact Hilti.
- Refer to the Hilti North America Post-Installed Reinforcing Bar Guide for detailed explanation, background information, and design examples. See Hilti Instructions for Use (IFU) for specific installation requirements.

3.2.4

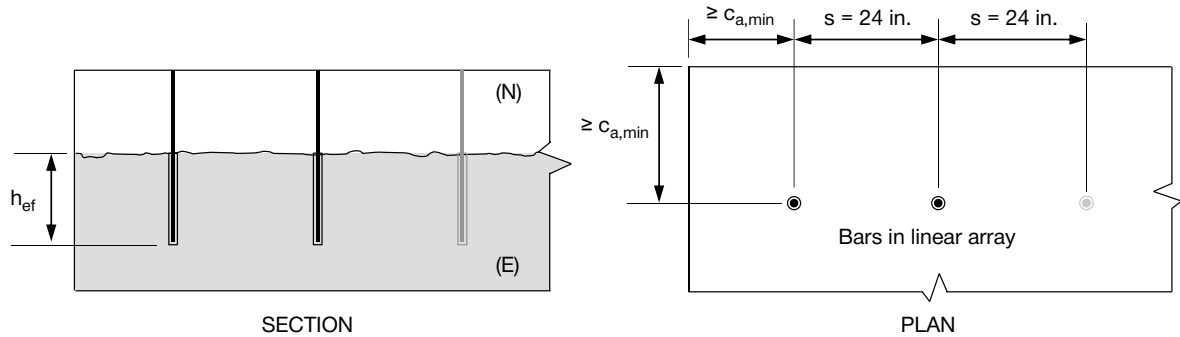

Illustration of Table 85 dimensions

3.2.4 HIT-RE 500 V3 Epoxy Adhesive Anchoring System

Table 89 - Suggested embedment and edge distance (see figure below) based on ACI 318-14 Chapter 17 to develop 125% of f_y in Grade 60 wall/column starter bars in a linear array with bar spacing = 18 inches - SDC A and B only^{1,2,3,4,5,6}

Rebar size	Linear spacing s in.	$f'_c = 2,500$ psi				$f'_c = 3,000$ psi				$f'_c = 4,000$ psi				$f'_c = 6,000$ psi			
		Effective embed. h_{ef} in.	Minimum edge dist $C_{a,min}$ in.		Effective embed. h_{ef} in.	Minimum edge dist $C_{a,min}$ in.		Effective embed. h_{ef} in.	Minimum edge dist $C_{a,min}$ in.		Effective embed. h_{ef} in.	Minimum edge dist $C_{a,min}$ in.					
			Cond. I	Cond. II		Cond. I	Cond. II		Cond. I	Cond. II		Cond. I	Cond. II				
#3	18	7	17	8	6	16	7	6	16	7	5	15	6				
#4		10	26	14	9	23	13	8	22	10	7	20	9				
#5		-	-	-	-	-	-	-	13	36	19	10	28	14			

- h_{ef} is the calculated bar embedment based on uncracked bond and concrete breakout strengths using equations in section 3.1.14.4 to develop 125% of nominal bar yield. Shaded embedment values exceed 20 bar diameters. For non-tabulated rebar sizes, design per development length provisions is recommended. The particular assumptions used for the application of anchor theory to bar development (e.g., bar yield and bond strength values) are a matter of engineering judgment and will in part depend on the specific circumstances of the design. For embedments corresponding to nominal yield (i.e., no overstrength) multiply the tabulated h_{ef} values by 0.86.
- C_a is the minimum edge distance (from bar centerline) associated with the tabulated embedments and $s = 18$ in. Refer to sec. 3.1.14.3 for applicability of edge distance "Condition I" and "Condition II."
- Applicable for hammer-drilled holes. For rock-drilled and core-drilled holes, contact Hilti.
- Values determined with bond stresses, k-factors and strength reduction factors taken from ESR-3814 Tables 12 and 13 assuming dry concrete conditions where concrete temperatures will not exceed a maximum short-term temperature of 130°F (55°C) and long-term temperature of 110°F (43°C). Bond stresses are for static (non-seismic) loading conditions.
- Values are for normal weight concrete. For lightweight concrete contact Hilti.
- Refer to the Hilti North America Post-Installed Reinforcing Bar Guide for detailed explanation, background information, and design examples. See Hilti Instructions for Use (IFU) for specific installation requirements.

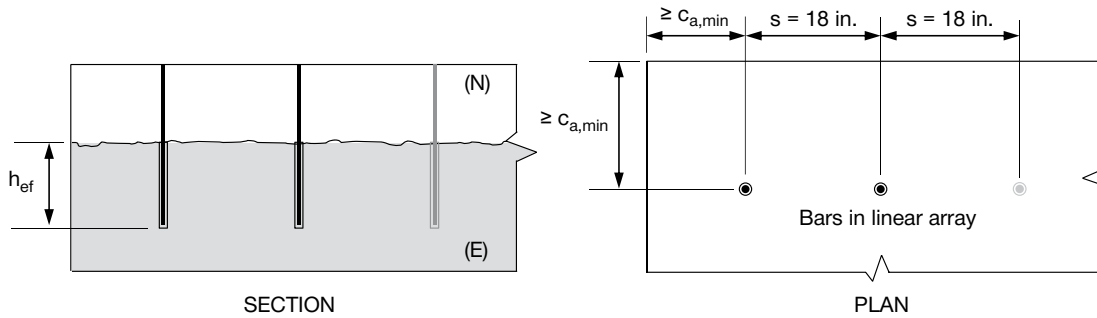

Illustration of Table 86 dimensions

HIT-RE 500 V3 Epoxy Adhesive Anchoring System 3.2.4

Table 90 - Suggested embedment and edge distance (see figure below) based on ACI 318-14 Chapter 17 to develop 125% of f_y in Grade 60 wall/column starter bars in a linear array with bar spacing = 12 inches - SDC A and B only^{1,2,3,4,5,6}

Rebar size	Linear spacing s in.	$f'_c = 2,500$ psi			$f'_c = 3,000$ psi			$f'_c = 4,000$ psi			$f'_c = 6,000$ psi		
		Effective embed. h_{ef} in.	Minimum edge dist $c_{a,min}$ in.		Effective embed. h_{ef} in.	Minimum edge dist $c_{a,min}$ in.		Effective embed. h_{ef} in.	Minimum edge dist $c_{a,min}$ in.		Effective embed. h_{ef} in.	Minimum edge dist $c_{a,min}$ in.	
			Cond. I	Cond. II		Cond. I	Cond. II		Cond. I	Cond. II		Cond. I	Cond. II
#3	12	7	17	10	6	16	9	6	16	7	5	15	6
#4		-	-	-	-	-	-	-	11	31	16	8	24

- h_{ef} is the calculated bar embedment based on uncracked bond and concrete breakout strengths using equations in section 3.1.14.4 to develop 125% of nominal bar yield. Shaded embedment values exceed 20 bar diameters. For non-tabulated rebar sizes, design per development length provisions is recommended. The particular assumptions used for the application of anchor theory to bar development (e.g., bar yield and bond strength values) are a matter of engineering judgment and will in part depend on the specific circumstances of the design. For embedments corresponding to nominal yield (i.e., no overstrength) multiply the tabulated h_{ef} values by 0.86.
- c_a is the minimum edge distance (from bar centerline) associated with the tabulated embedments and $s = 12$ in. Refer to sec. 3.1.14.3 for applicability of edge distance "Condition I" and "Condition II."
- Applicable for hammer-drilled holes. For rock-drilled and core-drilled holes, contact Hilti.
- Values determined with bond stresses, k-factors and strength reduction factors taken from ESR-3814 Tables 12 and 13 assuming dry concrete conditions where concrete temperatures will not exceed a maximum short-term temperature of 130°F (55°C) and long-term temperature of 110°F (43°C). Bond stresses are for static (non-seismic) loading conditions.
- Values are for normal weight concrete. For lightweight concrete contact Hilti.
- Refer to the Hilti North America Post-Installed Reinforcing Bar Guide for detailed explanation, background information, and design examples. See Hilti Instructions for Use (IFU) for specific installation requirements.

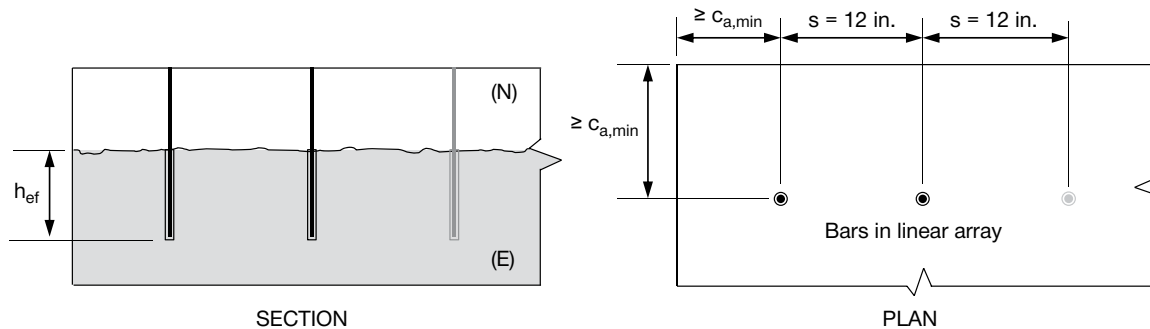

Illustration of Table 87 dimensions

3.2.4 HIT-RE 500 V3 Epoxy Adhesive Anchoring System

Table 91 - Calculated tension development and Class B Splice lengths for Canadian 400 MPa bars in walls, slabs, columns, and footings per CSA 23.3-14 for Hilti HIT-RE 500 V3 - non-seismic design only^{3,4,5,6,7,8}

Rebar size	$d_{cs} + K_{tr}$	min. edge dist. mm ¹	min. spacing mm ²	$f'_c = 20$ MPa		$f'_c = 25$ MPa		$f'_c = 30$ MPa		$f'_c = 40$ MPa	
				ℓ_d mm	Class B splice mm	ℓ_d mm	Class B splice mm	ℓ_d mm	Class B splice mm	ℓ_d mm	Class B splice mm
10M	2.5 d_b	60	50	300	380	300	340	300	310	300	300
15M		70	75	410	540	370	480	340	440	300	380
20M		80	100	510	660	450	490	410	540	360	460
25M		120	125	820	1,060	730	950	670	870	580	750
30M		130	150	960	1,250	860	1,120	790	1,020	680	890

- Edge distances are determined using the minimum cover specified by ESR-3184 with an additional 6% of the development length per suggestions for drilling without an aid per Hilti Post-Installed Reinforcing Bar Guide Section 3.3. Smaller edge distances may be possible, for which development and splice lengths may need to be recalculated. For further information on required cover see CSA A23.1-14 Table 17; see Sec. 3.2 for determination of d_{cs} .
- Spacing values represent those producing $d_{cs} = 5d_b$. Smaller spacing values may be possible, for which development and splice lengths may need to be recalculated. For further information on required spacing see CSA A23.1 Sec. 6.6.5.2; see Sec. 3.2 for determination of d_{cs} .
- k_1 and k_2 as defined by CSA A23.3-14 12.2.4 (a) and (b), are taken as 1.0 for post-installed reinforcing bars. For additional information see May-June 2013 issue of the ACI Structural Journal, "Recommended Procedures for Development and Splicing of Post-Installed Bonded Reinforcing Bars in Concrete Structures" by Charney, Pal and Silva.
- $k_4 = 0.8$ for 20M bars and smaller bars, 1.0 for 25M and larger bars. See CSA A23.3-14 12.2.4 (d).
- K_{tr} is assumed to equal zero.
- Values are for normal weight concrete. For lightweight concrete, multiply development and splice lengths by 1.3.
- Development and splice length values are for static design. For tension development and splice lengths of bars in joints, see CSA A23.3-14 21.3.3.5. For further information about reinforcement in seismic design, see CSA A23.3-14 Ch. 21.
- Refer to the Hilti North America Post-Installed Reinforcing Bar Guide for further explanation, background information, and design examples.

HIT-RE 500 V3 Epoxy Adhesive Anchoring System 3.2.4

Table 92 - Suggested embedment, edge distance, and spacing (see figure below) to develop 125% of f_y in Canadian 400 MPa bars based on CSA 23.3-14 Annex D - non-seismic design only^{1,2,3,4,5,6,7}

Rebar size	$f'_c = 20$ MPa				$f'_c = 25$ MPa				$f'_c = 30$ MPa				$f'_c = 40$ MPa			
	Effective embed. h_{ef} mm	Minimum edge dist $c_{a,min}$ in.		Min. spacing s_{min} mm	Effective embed. h_{ef} mm	Minimum edge dist $c_{a,min}$ in.		Min. spacing s_{min} mm	Effective embed. h_{ef} mm	Minimum edge dist $c_{a,min}$ in.		Min. spacing s_{min} mm	Effective embed. h_{ef} mm	Minimum edge dist $c_{a,min}$ in.		Min. spacing s_{min} mm
		Cond. I	Cond. II			Cond. I	Cond. II			Cond. I	Cond. II			Cond. I	Cond. II	
10M	180	480	220	440	170	470	200	400	160	450	190	380	150	430	180	350
15M	260	690	350	690	240	670	320	640	230	650	300	600	220	620	280	550
20M	310	850	450	900	300	820	420	840	280	800	400	790	270	760	360	720
25M	420	1,140	630	1,260	400	1,080	590	1,170	380	1,050	560	1,110	350	1,000	500	1,000
30M	530	1,420	790	1,580	490	1,340	740	1,470	460	1,280	690	1,380	420	1,200	630	1,260

- For additional information see May-June 2013 issue of the ACI Structural Journal, "Recommended Procedures for Development and Splicing of Post-Installed Bonded Reinforcing Bars in Concrete Structures" by Charney, Pal and Silva.
- h_{ef} is the calculated bar embedment based on uncracked bond and concrete breakout strengths using equations in section 3.1.14.3 to develop 125% of nominal bar yield. Bond stresses apply for sustained and non-sustained load conditions. Additional reductions per ACI 318-14, 17.3.1.2 are not included, however, and as such these embedments are not intended for sustained tension load applications. The particular assumptions used for the application of anchor theory to bar development (e.g., bar yield and bond strength values) are a matter of engineering judgment and will in part depend on the specific circumstances of the design. For embedments corresponding to nominal yield (i.e., no overstrength) multiply the unbolded and bolded tabulated h_{ef} values by 0.80 and 0.86, respectively. Reduction factors for non-sustained loading and no bar overstrength may be combined.
- c_a and s are the minimum edge distance and bar spacing (from bar centerline) associated with the tabulated embedments. Refer to sec. 3.1.14.3 for applicability of edge distance "Condition I" and "Condition II."
- Applicable for hammer-drilled holes. For rock-drilled and core-drilled holes, contact Hilti.
- Values determined with bond stresses, k-factors and strength reduction factors taken from ESR-3814 Tables 12 and 13 assuming dry, uncracked concrete conditions where concrete temperatures will not exceed a maximum short-term temperature of 130°F (55°C) and long-term temperature of 110°F (43°C). Bond stresses are for static (non-seismic) loading conditions.
- Values are for normal weight concrete. For lightweight concrete contact Hilti.
- Refer to the Hilti North America Post-Installed Reinforcing Bar Guide for further explanation, background information, and design examples. See Hilti Instructions for Use (IFU) for specific installation requirements.

3.2.4

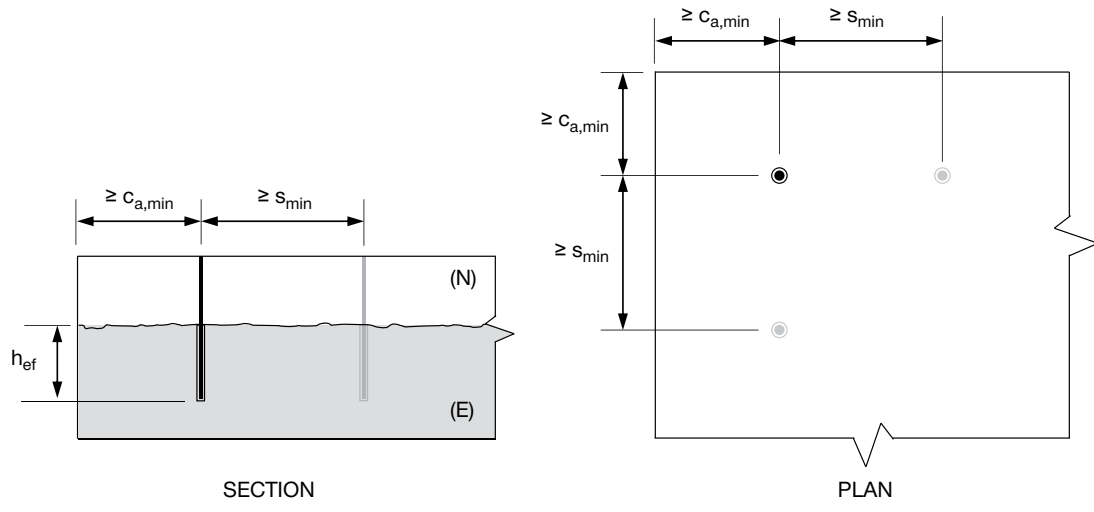

Illustration of Table 89 dimensions

3.2.4 HIT-RE 500 V3 Epoxy Adhesive Anchoring System

Table 93 - Suggested embedment and edge distance (see figure below) based on CSA 23.3 Annex D to develop 125% of f_y in Canadian 400 MPa wall/column starter bars in a linear array with bar spacing = 600 mm - non-seismic only^{1,2,3,4,5,6}

Rebar size	Linear spacing s mm	$f'_c = 20$ MPa			$f'_c = 25$ MPa			$f'_c = 30$ MPa			$f'_c = 40$ MPa		
		Effective embed. h_{ef} mm	Minimum edge dist $c_{a,min}$ mm		Effective embed. h_{ef} mm	Minimum edge dist $c_{a,min}$ mm		Effective embed. h_{ef} mm	Minimum edge dist $c_{a,min}$ mm		Effective embed. h_{ef} mm	Minimum edge dist $c_{a,min}$ mm	
			Cond. I	Cond. II		Cond. I	Cond. II		Cond. I	Cond. II		Cond. I	Cond. II
10M	600	180	480	220	170	470	200	160	450	190	150	430	180
15M		280	760	420	240	670	350	230	650	300	220	620	280
20M		-	-	-	430	1,220	650	380	1,080	570	310	890	460

- h_{ef} is the calculated bar embedment based on uncracked bond and concrete breakout strengths using equations in section 3.1.14.4 to develop 125% of nominal bar yield. Shaded embedment values exceed 20 bar diameters. For non-tabulated rebar sizes, design per development length provisions is recommended. The particular assumptions used for the application of anchor theory to bar development (e.g., bar yield and bond strength values) are a matter of engineering judgment and will in part depend on the specific circumstances of the design. For embedments corresponding to nominal yield (i.e., no overstrength) multiply the tabulated h_{ef} values by 0.86.
- c_a is the minimum edge distance (from bar centerline) associated with the tabulated embedments and $s = 600$ mm. Refer to sec. 3.1.14.3 for applicability of edge distance "Condition I" and "Condition II."
- Values determined with bond stresses, k-factors and strength reduction factors taken from ESR-3814, Tables 12 and 13 assuming dry, uncracked concrete conditions where concrete temperatures will not exceed a maximum short-term temperature of 130°F (55°C) and long-term temperature of 110°F (43°C). Bond stresses are for static (non-seismic) loading conditions.
- Values are for normal weight concrete. For lightweight concrete contact Hilti.
- Refer to the Hilti North America Post-Installed Reinforcing Bar Guide for further explanation, background information, and design examples. See Hilti Instructions for Use (IFU) for specific installation requirements.

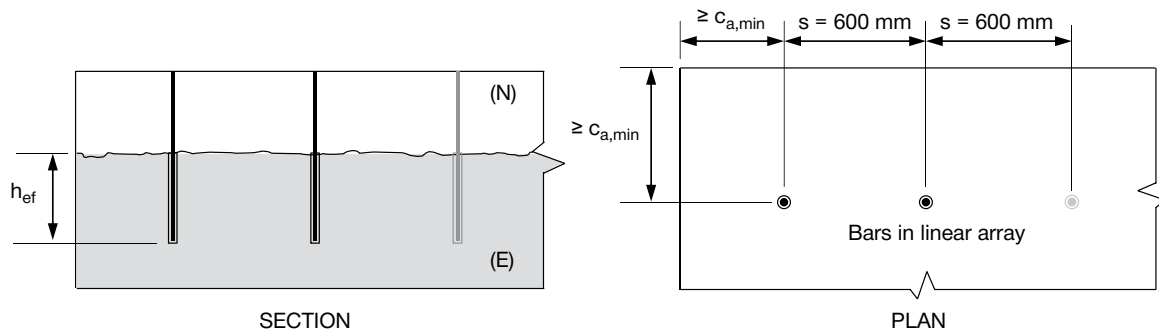

Illustration of Table 90 dimensions

HIT-RE 500 V3 Epoxy Adhesive Anchoring System 3.2.4

Table 94 - Suggested embedment and edge distance (see figure below) based on CSA 23.3 Annex D to develop 125% of f_y in Canadian 400 MPa wall/column starter bars in a linear array with bar spacing = 450 mm - non-seismic only^{1,2,3,4,5,6}

Rebar size	Linear spacing s mm	$f'_c = 20 \text{ MPa}$				$f'_c = 25 \text{ MPa}$				$f'_c = 30 \text{ MPa}$				$f'_c = 40 \text{ MPa}$			
		Effective embed. h_{ef} mm	Minimum edge dist $C_{a,min}$ mm		Effective embed. h_{ef} mm	Minimum edge dist $C_{a,min}$ mm		Effective embed. h_{ef} mm	Minimum edge dist $C_{a,min}$ mm		Effective embed. h_{ef} mm	Minimum edge dist $C_{a,min}$ mm		Effective embed. h_{ef} mm	Minimum edge dist $C_{a,min}$ mm		
			Cond. I	Cond. II		Cond. I	Cond. II		Cond. I	Cond. II		Cond. I	Cond. II				
10M	450	180	480	220	170	470	200	160	450	190	150	430	180				
15M		400	1,090	590	340	950	510	300	840	440	240	690	360				

- h_{ef} is the calculated bar embedment based on uncracked bond and concrete breakout strengths using equations in section 3.1.14.4 to develop 125% of nominal bar yield. Shaded embedment values exceed 20 bar diameters. For non-tabulated rebar sizes, design per development length provisions is recommended. The particular assumptions used for the application of anchor theory to bar development (e.g., bar yield and bond strength values) are a matter of engineering judgment and will in part depend on the specific circumstances of the design. For embedments corresponding to nominal yield (i.e., no overstrength) multiply the tabulated h_{ef} values by 0.86.
- c_a is the minimum edge distance (from bar centerline) associated with the tabulated embedments and $s = 450 \text{ mm}$. Refer to sec. 3.1.14.3 for applicability of edge distance "Condition I" and "Condition II."
- Values determined with bond stresses, k-factors and strength reduction factors taken from ESR-3814, Tables 12 and 13 assuming dry, uncracked concrete conditions where concrete temperatures will not exceed a maximum short-term temperature of 130°F (55°C) and long-term temperature of 110°F (43°C). Bond stresses are for static (non-seismic) loading conditions.
- Values are for normal weight concrete. For lightweight concrete contact Hilti.
- Refer to the Hilti North America Post-Installed Reinforcing Bar Guide for further explanation, background information, and design examples. See Hilti Instructions for Use (IFU) for specific installation requirements.

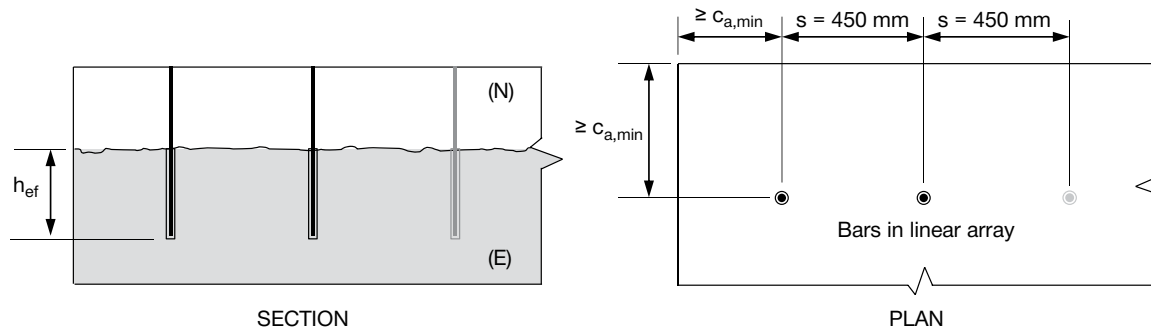

Illustration of Table 91 dimensions

3.2.4 HIT-RE 500 V3 Epoxy Adhesive Anchoring System

Table 95 - Suggested embedment and edge distance (see figure below) based on CSA 23.3 Annex D to develop 125% of f_y in Canadian 400 MPa wall/column starter bars in a linear array with bar spacing = 300 mm - non-seismic only^{1,2,3,4,5,6}

Rebar size	Linear spacing s mm	$f'_c = 20$ MPa				$f'_c = 25$ MPa				$f'_c = 30$ MPa				$f'_c = 40$ MPa			
		Effective embed. h_{ef} mm	Minimum edge dist $c_{a,min}$ mm		Effective embed. h_{ef} mm	Minimum edge dist $c_{a,min}$ mm		Effective embed. h_{ef} mm	Minimum edge dist $c_{a,min}$ mm		Effective embed. h_{ef} mm	Minimum edge dist $c_{a,min}$ mm		Effective embed. h_{ef} mm	Minimum edge dist $c_{a,min}$ mm		
			Cond. I	Cond. II		Cond. I	Cond. II		Cond. I	Cond. II		Cond. I	Cond. II				
10M	300	240	650	350	200	560	300	180	500	260	160	450	210				

- h_{ef} is the calculated bar embedment based on uncracked bond and concrete breakout strengths using equations in section 3.1.14.4 to develop 125% of nominal bar yield. Shaded embedment values exceed 20 bar diameters. For non-tabulated rebar sizes, design per development length provisions is recommended. The particular assumptions used for the application of anchor theory to bar development (e.g., bar yield and bond strength values) are a matter of engineering judgment and will in part depend on the specific circumstances of the design. For embedments corresponding to nominal yield (i.e., no overstrength) multiply the tabulated h_{ef} values by 0.86.
- c_a is the minimum edge distance (from bar centerline) associated with the tabulated embedments and $s = 300$ mm. Refer to sec. 3.1.14.3 for applicability of edge distance "Condition I" and "Condition II."
- Values determined with bond stresses, k-factors and strength reduction factors taken from ESR-3814, Tables 12 and 13 assuming dry, uncracked concrete conditions where concrete temperatures will not exceed a maximum short-term temperature of 130°F (55°C) and long-term temperature of 110°F (43°C). Bond stresses are for static (non-seismic) loading conditions.
- Values are for normal weight concrete. For lightweight concrete contact Hilti.
- Refer to the Hilti North America Post-Installed Reinforcing Bar Guide for further explanation, background information, and design examples. See Hilti Instructions for Use (IFU) for specific installation requirements.

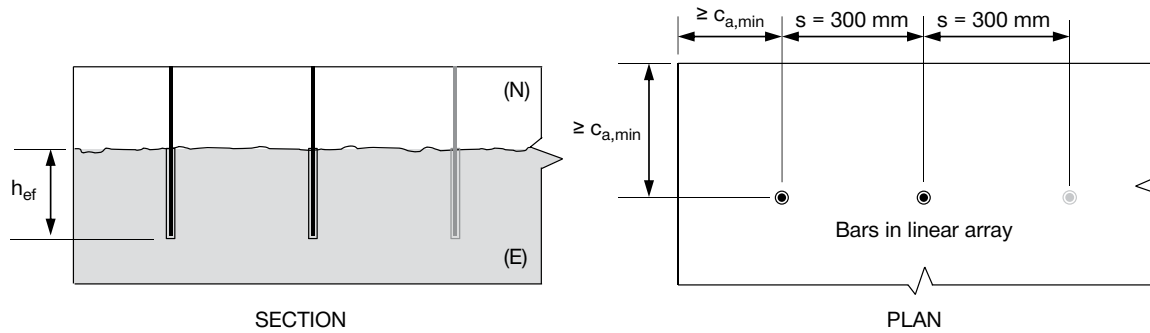



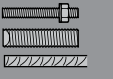



Illustration of Table 92 dimensions

HIT-RE 500 V3 Epoxy Adhesive Anchoring System 3.2.4

3.2.4.4 Installation instructions

Installation Instructions For Use (IFU) are included with each product package. They can also be viewed or downloaded online at www.hilti.com. Because of the possibility of changes, always verify that downloaded IFU are current when used. Proper installation is critical to achieve full performance. Training is available on request. Contact Hilti Technical Services for applications and conditions not addressed in the IFU.

Figure 9 - Hilti HIT-RE 500 V3 adhesive cure and working time (approx.)

					
	[°F]	[°C]	t _{work}	t _{cure, ini}	t _{cure, full}
	23	-5	2 h	48 h	168 h
	32	0	2 h	24 h	36 h
	40	4	2 h	16 h	24 h
	50	10	1.5 h	12 h	16 h
	60	16	1 h	8 h	16 h
	72	22	25 min	4 h	6.5 h
	85	29	15 min	2.5 h	5 h
	95	35	12 min	2 h	4.5 h
	105	41	10 min	2 h	4 h

 ≥ +5 °C / 41 °F

 = 2x t_{cure}

Table 96 - Resistance of cured Hilti HIT-RE 500 V3 to chemicals

Chemicals tested	Content (%)	Resistance
toluene	47.5	+
iso-octane	30.4	
heptane	17.1	
methanol	3	
butanol	2	+
toluene	60	
xylene	30	
methylnaphthalene	10	
diesel	100	+
petrol	100	+
methanol	100	-
dichloromethane	100	-
mono-chlorobenzene	100	●
ethylacetat	50	+
methylisobutylketone	50	
salicylic acid-methylester	50	+
mcetophenon	50	
acetic acid	50	-
propionic acid	50	
sulfuric acid	100	
nitric acid	100	-
hydochloric acid	36	-
potassium hydroxide	100	-
sodium hydroxide 20%	100	-
triethanolamine	50	-
butylamine	50	
benzyl alcohol	100	-
ethanol	100	
ethyl acetate	100	
methyl ethly ketone (MEK)	100	
trichlorethylene	100	
lutensit TC KLC 50	3	
marlophen NP 9,5	2	
water	95	+
tetrahydrofurane	100	
demineralized water	100	+
salt water	saturated	+
salt spray testing	-	+
SO ₂	-	+
environment/weather	-	+
oil for formwork (forming oil)	100	+
concrete plasticizer	-	+
concrete drilling mud	-	+
concrete potash solution	-	+
saturated suspension of bore-hole cuttings	-	+

- + Resistant
- Partially resistant
- Not resistant

 3.2.4

3.2.4 HIT-RE 500 V3 Epoxy Adhesive Anchoring System

3.2.4.5 Ordering information



HIT-RE 500 V3

Description	Package contents	Qty
HIT-RE 500 V3 (11.1 fl oz/330 ml)	Includes (1) foil pack with (1) mixer and 3/8 filler tube per pack	1
HIT-RE 500 V3 Master Carton (11.1 fl oz/330 ml)	Includes (1) master carton containing (25) foil packs with (1) mixer and 3/8 filler tube per pack	25
HIT-RE 500 V3 Combo (11.1 fl oz/330 ml)	Includes (1) master carton containing (25) foil packs with (1) mixer and 3/8 filler tube per pack and (1) HDM 500 Manual Dispenser	25
HIT-RE 500 V3 Master Carton (16.9 fl oz/500 ml)	Includes (1) master carton containing (20) foil packs with (1) mixer and 3/8 filler tube per pack	20
HIT-RE 500 V3 Combo (16.9 fl oz/500 ml)	Includes (2) master cartons containing (20) foil packs each with (1) mixer and 3/8 filler tube per pack and (1) HDM 500 Manual Dispenser	40
HIT-RE 500 V3 (47.3 fl oz/1400 ml)	Includes (4) foil packs with (1) mixer and 3/8 filler tube per pack	4
HIT-RE 500 V3 Pallet (47.3 fl oz/1400 ml)	Includes (64) foil packs with (1) mixer and 3/8 filler tube per pack and (1) P800 Pneumatic Dispenser	64
HIT-RE 500 V3 TE-CD Starter Package	Includes foil packs, dispensers, vacuum, hammer drill and various drill bit sizes. Contact Hilti for exact package contents.	40
HIT-RE 500 V3 TE-YD Starter Package	Includes foil packs, dispensers, vacuum, hammer drill and various drill bit sizes. Contact Hilti for exact package contents.	40
HIT-RE-M Static Mixer For use with HIT-RE 500 V3 cartridges		1



TE-YRT Roughening Tool

Order description	Description	Length
TE-YRT 7/8" x 15"	Roughening tool for use with 3/4" diameter threaded rod in core drilled holes	15"
TE-YRT 1-1/8" x 20"	Roughening tool for use with 1" diameter threaded rod in core drilled holes	20"
TE-YRT 1-3/8" x 25"	Roughening tool for use with 1-1/4" diameter threaded rod in core drilled holes	25"
RTG 7/8"	Roughening tool gauge for TE-YRT 7/8"	
RTG 1-1/8"	Roughening tool gauge for TE-YRT 1-1/8"	
RTG 1-3/8"	Roughening tool gauge for TE-YRT 1-3/8"	



TE-CD Hollow Drill Bits

Order description	Working length
Hollow Drill Bit TE-CD 1/2" x 13"	8"
Hollow Drill Bit TE-CD 9/16" x 14"	9-1/2"
Hollow Drill Bit TE-CD 5/8" x 14"	9-1/2"
Hollow Drill Bit TE-CD 3/4" x 14"	9-1/2"



TE-YD Hollow Drill Bits

Order description	Working length
Hollow drill bit TE-YD 5/8" x 24"	15-3/4"
Hollow drill bit TE-YD 3/4" x 24"	15-3/4"
Hollow drill bit TE-YD 7/8" x 24"	15-3/4"
Hollow drill bit TE-YD 1" x 24"	15-3/4"
Hollow drill bit TE-YD 1-1/8" x 24"	15-3/4"
Hollow drill bit TE-YD 5/8" x 35"	26"
Hollow drill bit TE-YD 3/4" x 35"	26"
Hollow drill bit TE-YD 7/8" x 35"	26"
Hollow drill bit TE-YD 1" x 35"	26"
Hollow drill bit TE-YD 1-1/8" x 47"	39"